



USER MANUAL

MODEL:

MTX3-88-SE

**4K 8x8 Seamless Matrix
Switcher/Multi-Scaler**

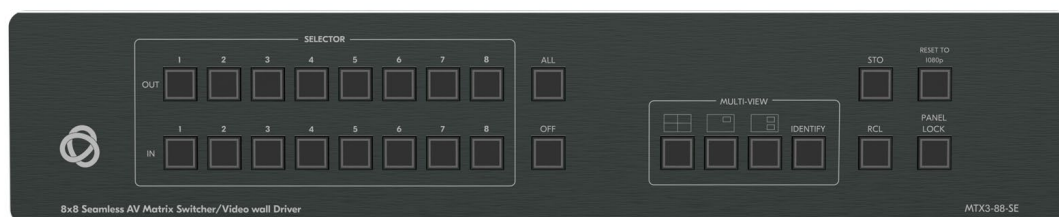

Contents

Introduction	1
Getting Started	1
Overview	2
Typical Applications	4
Defining MTX3-88-SE	5
Mounting MTX3-88-SE	8
Connecting MTX3-88-SE	9
Connecting the Audio Line to a Balanced/Unbalanced Stereo Audio Acceptor	10
Connecting to MTX3-88-SE via RS-232	10
Operating and Controlling the MTX3-88-SE	11
Principles of Operation	11
Operating the Device using the Device Panel Buttons	11
Operating via Ethernet	17
Using Embedded Web Pages	21
8x8 AV Matrix Routing Operation and Settings	24
Multi-View Operation Mode Settings	27
Data Routing	42
Managing EDID	44
Picture Settings	46
Setting Device Properties	49
Setting Control Gateway Properties	53
Setting Security Status	54
Viewing the About Page	59
Upgrading the Firmware	60
Setting the DIP-Switches	60
Technical Specifications	61
Default Communication Parameters	62
Protocol 3000	63
Understanding Protocol 3000	63
Protocol 3000 Commands	64
Result and Error Codes	84

Introduction

Welcome to Kramer Electronics! Since 1981, Kramer Electronics has been providing a world of unique, creative, and affordable solutions to the vast range of problems that confront the video, audio, presentation, and broadcasting professional on a daily basis. In recent years, we have redesigned and upgraded most of our line, making the best even better!

Getting Started

We recommend that you:

- Unpack the equipment carefully and save the original box and packaging materials for possible future shipment.
- Review the contents of this user manual.



Go to www.kramerav.com/downloads/MTX3-88-SE to check for up-to-date user manuals, application programs, and to check if firmware upgrades are available (where appropriate).

Achieving Best Performance

- Use only good quality connection cables (we recommend Kramer high-performance, high-resolution cables) to avoid interference, deterioration in signal quality due to poor matching, and elevated noise levels (often associated with low quality cables).
- Do not secure the cables in tight bundles or roll the slack into tight coils.
- Avoid interference from neighboring electrical appliances that may adversely influence signal quality.
- Position your Kramer **MTX3-88-SE** away from moisture, excessive sunlight and dust.

Safety Instructions



Caution:

- This equipment is to be used only inside a building. It may only be connected to other equipment that is installed inside a building.
- For products with relay terminals and GPIO ports, please refer to the permitted rating for an external connection, located next to the terminal or in the User Manual.
- There are no operator serviceable parts inside the unit.



Warning:

- Use only the power cord that is supplied with the unit.
- Disconnect the power and unplug the unit from the wall before installing.
- Do not open the unit. High voltages can cause electrical shock! Servicing by qualified personnel only.
- To ensure continuous risk protection, replace fuses only according to the rating specified on the product label which is located on the bottom of the unit.

Recycling Kramer Products

The Waste Electrical and Electronic Equipment (WEEE) Directive 2002/96/EC aims to reduce the amount of WEEE sent for disposal to landfill or incineration by requiring it to be collected and recycled. To comply with the WEEE Directive, Kramer Electronics has made arrangements with the European Advanced Recycling Network (EARN) and will cover any costs of treatment, recycling and recovery of waste Kramer Electronics branded equipment on arrival at the EARN facility. For details of Kramer's recycling arrangements in your particular country go to our recycling pages at www.kramerav.com/il/quality/environment.

Overview

Congratulations on purchasing your Kramer **MTX3-88-SE** 8x8 4K60 Seamless Multi-Viewer Matrix.

The **MTX3-88-SE** is a high-performance video processing seamless matrix scaler, with eight HDMI inputs independently routable to eight HDMI outputs. The matrix features an additional HDBT input and two mirrored HDBT outputs allowing local and remote presentation of high-quality video.

Exceptional Quality

- **Powerful Multi-viewer** — High-resolution flexible multi-view processor options, including simultaneously displaying dual quad-view presentations and Picture(s)-In-Picture, concurrently mirrored on output displays.
- **Seamless Switching** — Clean and instantaneous switching between inputs, with smooth and uninterrupted transition between presented content on displays, greatly enhances end-users' presentation experience.
- **High-Performance Scaling Experience** — Built-in ProcAmp high-resolution scaling technology for optimal up or down image scaling and video signal auto-adjustment with output-connected display capabilities, to gain end-users' valuable high presentation experience.
- **HDMI Signal Switching** — HDCP 2.2 compliant, supporting deep color, x.v.Color™, CEC, HDMI uncompressed audio channels, Dolby TrueHD, DTS-HD, 2K, 4K, and 3D as specified in HDMI 2.0.

Advanced and User-friendly Operation

- **Simple Control** — Remote IP-controller connection, browser operation webpage, or local panel buttons, and eight multi-view preset configurations, for easy and fully flexible user ports selection, signals routing, multi-view switching, and matrix control.
- **Comprehensive Management** — Local panel-button operation, remote IP-driven firmware upgrade and management via user-friendly embedded web pages, and remote IP or local serial service and management via API commands and responses communication, for flexible service options and ensure lasting, field proven deployment.

Flexible Connectivity

- Built-in Intelligent Control Gateway — Remote IP-driven intelligent serial control of connected devices to reduce installation complexity and costs, and to enable easy integration with control systems, such as Kramer Control.
- Secured Operation — Standard IT-grade 802.1x authentication for secured IT LAN connectivity operation.
- High Performance Standard Extension — Professional HDBaseT extension, providing extended-reach signals over twisted-pair copper infrastructures, for remote input source, and mirrored matrix dual outputs content on remote displays. Conveying multiple audio-visual, Ethernet, control and power signals, matrix open-standard extension can be connected to any market-available HDBaseT-compliant extension products. For optimum extension reach and performance, use recommended Kramer cables.
- I-EDIDPro™ Kramer Intelligent EDID Processing™ — Intelligent EDID handling and ensures plug & play operation for HDMI source and display systems.
- Audio De-embedding — The digital audio signal passing through to selectable outputs, is de-embedded, converted to an analog signal and sent to four stereo balanced analog audio outputs. This enables playing the audio on a locally connected professional audio system (such as DSP) and speakers, in parallel to playing it on the speakers connected to the AV acceptor devices (such as TVs with speakers).
- Multi-channel Audio Transmission — Up to 32 channels of digital stereo uncompressed signals for supporting studio-grade surround sound.
- Flexible USB Routing and Extension — USB 2.0 signals extension are flexibly routed between HDBT input and output links, enabling a remote active USB host connection to the remote USB devices connected to the routed HDBT extender end-point, such as camera and audio devices, in parallel to its locally connected USB devices transmitter or receiver side, such as HID (Human Interface Devices) mouse or keyboard devices.
- Ethernet Extension — Ethernet interface data flows in both directions, allowing extension of up to 1 Gbps Ethernet connectivity for LAN communication and device control.
- Bidirectional RS-232 Extension — Serial interface data flows in both directions, allowing data transmission and device control.
- Bidirectional Infrared Extension — IR interface data flows in both directions, allowing remote control of peripheral devices located at either end of the extended line.
- Easy and Elegant Installation — Single cable connectivity for both HDBaseT signals and PoE power distribution with only a single power mains connection.

Typical Applications

MTX3-88-SE is ideal for the following typical applications:

- Control Center multi-view operations.
- Seamless routable presentations in large-space facilities, such as conference halls, visitor centers, boardrooms, and auditoriums.

Controlling your MTX3-88-SE

Control your **MTX3-88-SE** directly via the front panel push buttons (with on-screen menus, or:

- Via the IP commands transmitted by a controller and touch screen system, or a browser using built-in user-friendly Web pages.
- By RS-232 serial commands transmitted by a touch screen system, PC, or a serial controller.

Defining MTX3-88-SE

This section defines **MTX3-88-SE**.

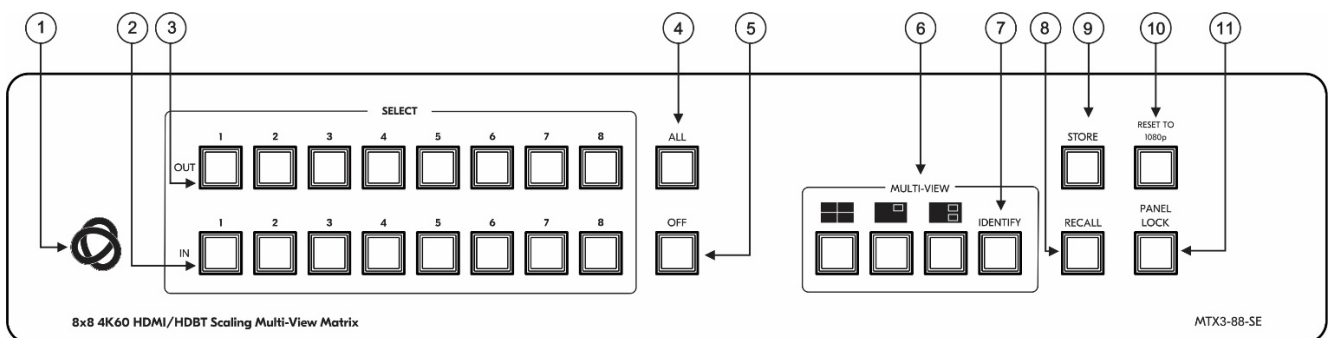

Figure 1: MTX3-88-SE 4K 8x8 Seamless Matrix Switcher/Multi-Scaler Front Panel

#	Feature	Function
①	ON LED (behind the logo)	On when power is supplied to the unit.
②	IN SELECT Buttons (1 to 8)	Press to select the input to switch after selecting an output (also used for storing machine setups).
③	OUT SELECT Buttons (1 to 8)	Press to select an output to which the input is routed.
④	ALL Button	Press followed by an input button selection to connect the selected input to all outputs. For example, press ALL and then press IN 2. Input 2 is routed to all outputs.
⑤	OFF Button	Press after pressing an output button to disconnect the selected output from the inputs. To disconnect all the outputs, press ALL followed by OFF.
⑥	MULTI-VIEW	Press once to enable one of the MULTI-VIEW modes (button LED lights): 1 X PIP, 2 X PIP, or Quad. Press any lit MULTI-VIEW button to return to Matrix mode (enabled by default, button LED turns off).
⑦	IDENTIFY Button	After pressing this button, the multi-view window number is displayed via OSD (O n S creen D isplay) for about 10 seconds within each multi-view window
⑧	RECALL Button	Press to recall a preset configuration: Recall a stored preset from any of the 4 presets via the front panel input buttons (1 to 4).
⑨	STORE Button	Press to store a configuration: Store 4 presets via the front panel input buttons (1 to 4).
⑩	RESET TO 1080p Button	Press and hold button for about 2 sec to set output resolution to 1080p.
⑪	PANEL LOCK Button	Press and hold to toggle the locking/release of the front panel buttons.

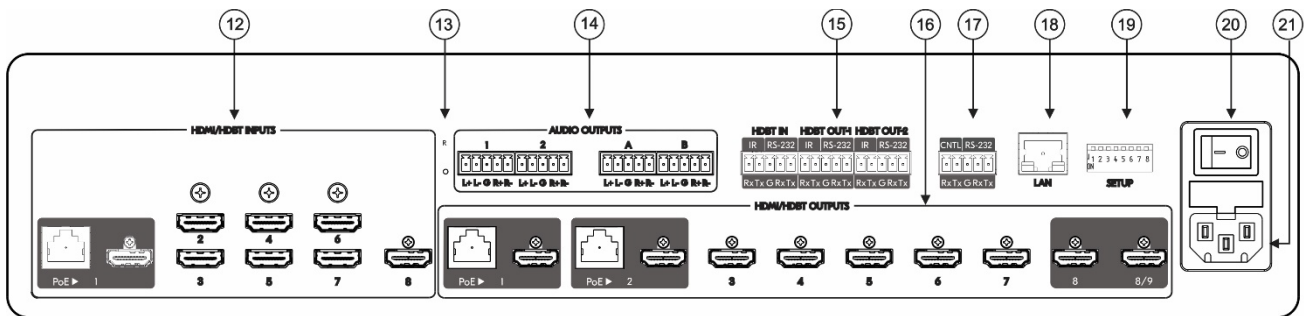



Figure 2: MTX3-88-SE 4K 8x8 Seamless Matrix Switcher/Multi-Scaler Rear Panel

#	Feature		Function
12	HDMI/HDBT INPUTS	HDBT 1 RJ-45 Connector	Connect to an HDBT transmitter and/or HDMI source. Input 1 is user configurable. You can select the active input connector via web-UI.
		HDMI 1 Connector	
		HDMI 2-8 Connectors	Connect to an HDMI source (2-8).
13	Recovery (Recessed Button)	For device restoring (for example, inactive device or failed boot-up): Before powering up the device, press the button and hold it down. Turn the unit on and release the button only after the device has completed its boot-up process.	
14	AUDIO OUTPUTS 5-pin Terminal Block Connectors	AUDIO OUTPUT 1-2	Connect to a stereo balanced audio acceptor (1 to 2) to output De-embedded audio from HDMI Output 1 or Output 2.
		AUDIO OUTPUT A-B	Connect to a stereo balanced audio acceptor (A to B) to output De-embedded audio from any HDMI 3-7 Outputs (default Output 3, or 4).
15	HDBT IN	IR (Rx, Tx) left 2-pins on a 5-pin Terminal Block Connectors	Connect to the IR connector of an HDBT output (Tx to Rx and Rx to Tx), to extend IR signals between an HDBT transmitter on the input and HDBT receiver on an output.
		RS-232 (G, Rx, Tx) right 3-pins on a 5-pin Terminal Block Connectors	Connect to a serial controller or RS-232 controlled device for RS-232 signal extension via the HDBT input.
	HDBT OUT-1 HDBT OUT-2	IR (Rx, Tx) left 2-pins on a 5-pin Terminal Block Connectors	Connect to the IR connector of an HDBT input (Tx to Rx and Rx to Tx), to extend IR signals between an HDBT receiver on an output and an HDBT transmitter on an input.
		RS-232 (G, Rx, Tx) right 3-pins on a 5-pin Terminal Block Connectors	Extend RS-232 signal between the HDBT port and the HDBT receiver: Connect to serially control a device connected to the HDBT receiver; or to serially control a local device using a controller connected to the HDBT receiver.
16	HDMI/HDBT OUTPUTS	HDBT/HDMI RJ-45/HDMI Connectors (1 to 2)	Connect to an HDBT receiver and/or HDMI acceptor (mirrors HDBT output signal).
		HDMI Connectors (3 to 8)	Connect to HDMI acceptors.
		HDMI Connectors (8/9)	Connect to an HDMI acceptor. Output 9 mirrors Output 8.
17	CNTL (Rx, Tx) 2-pin Terminal Block Connector	Connect to a PC to control MTX3-88-SE .	
	RS-232 (G, Rx, Tx) 3-pin Terminal Block Connector	Connect to a serially-controlled device to control the unit via IP (Default TCP port: 5001).	
18	LAN RJ-45 Connector	Connect to the LAN.  Make sure to connect only one HDBaseT endpoint (transmitter or receiver) to the network	

		equipment (switch or router). Connecting both endpoints to the network can cause network loops and signal issues.
①9	SETUP	For configuring the functionality of the IR and RS-232 ports (see Configuring IR and RS-232 over HDBT on page 14).
②0	Power Illuminated Switch	Turn the device on and off.
②1	Mains Power Connector and Fuse	Plug in the power cord.

Mounting MTX3-88-SE

This section provides instructions for mounting **MTX3-88-SE**. Before installing, verify that the environment is within the recommended range:



- Operation temperature – 0° to 40°C (32 to 104°F).
- Storage temperature – -40° to +70°C (-40 to +158°F).
- Humidity – 10% to 90%, RHL non-condensing.

**Caution:**

- Mount **MTX3-88-SE** before connecting any cables or power.

**Warning:**

- Ensure that the environment (e.g., maximum ambient temperature & air flow) is compatible for the device.
- Avoid uneven mechanical loading.
- Appropriate consideration of equipment nameplate ratings should be used for avoiding overloading of the circuits.
- Reliable earthing of rack-mounted equipment should be maintained.

Mount MTX3-88-SE in a rack:

- attach both rack ears (by removing the screws from each side of the matrix and replacing those screws through the rack ears) or place the matrix on a table.

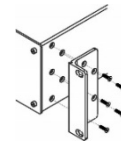

Connecting MTX3-88-SE

i Always switch off the power to each device before connecting it to your **MTX3-88-SE**. After connecting your **MTX3-88-SE**, connect its power and then switch on the power to each device.

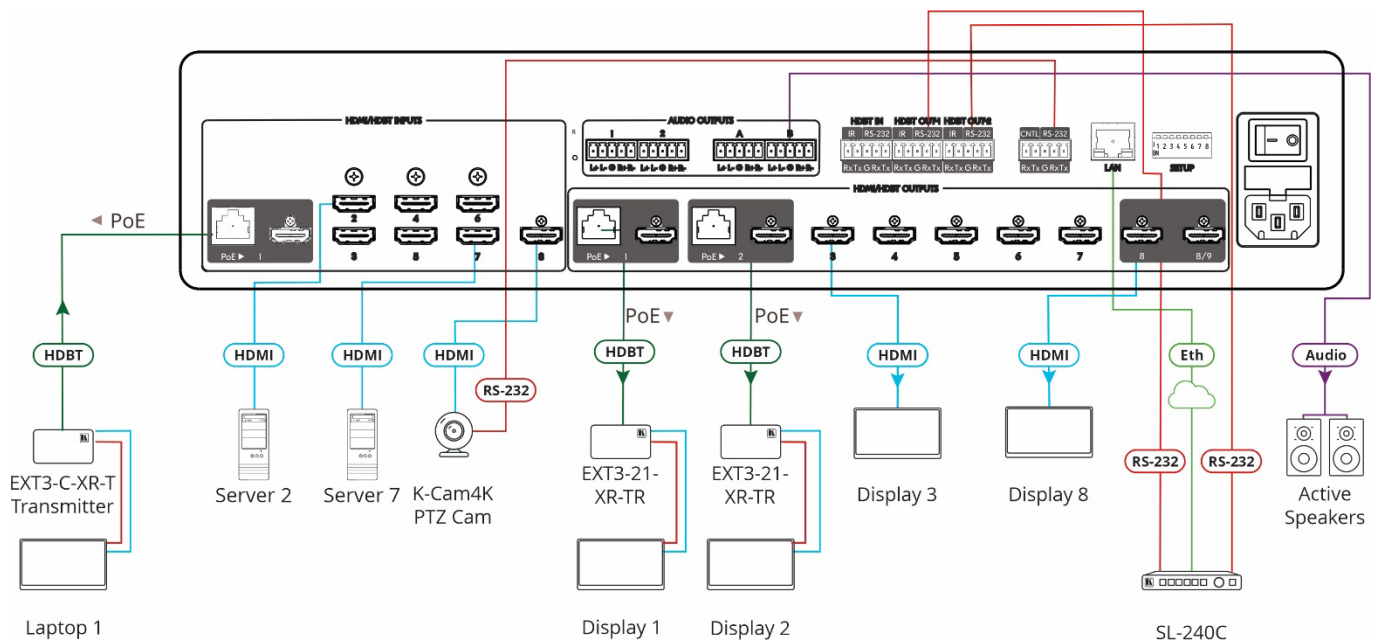

Figure 3: Connecting to the MTX3-88-SE Rear Panel

To connect **MTX3-88-SE** as illustrated in the example in [Figure 3](#):

1. Connect to HDBT input port 1 (12) an HDBT acceptor (for example, EXT3-C-XR-T, HDBT Transmitter).
2. Connect to HDMI INPUT connectors 2-8 (12) HDMI sources (for example, a server, a K-Cam4K camera, and so on).
3. Connect to HDBT output ports 1-2 (15) to HDBT acceptors (for example, EXT3-21-XR-TR, HDBT Receiver).
4. Connect to HDMI output connectors 3-8 (16) to HDMI displays (for example a TV, a projector or so on).
5. Connect to AUDIO OUT 5-pin terminal block connectors 1-4 (14) to balanced stereo audio acceptors (for example, Kramer active speakers).
6. Connect the RS-232 3-pin terminal block connector (17) to serially controlled source or display (for example, a K-Cam4K PTZ camera).
7. Connect the ETHERNET RJ-45 port (18) to a control system via LAN (for example Kramer SL-240C) and its RS-232 ports to HDBT RS-232 extension ports (12) (15).

! Make sure to connect only one HDBaseT endpoint (transmitter or receiver) to the network equipment (switch or router). Connecting both endpoints to the network can cause network loops and signal issues.

8. Connect the power to the mains electricity (not shown in [Figure 3](#)).

Connecting the Audio Line to a Balanced/Unbalanced Stereo Audio Acceptor

The following are the pinouts for connecting the output to a balanced or unbalanced stereo audio acceptor:

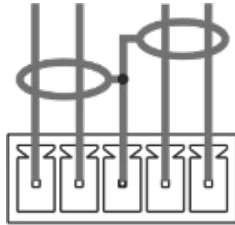

L+ L- G R+ R-

Figure 4: Connecting to a Balanced Stereo Audio Acceptor

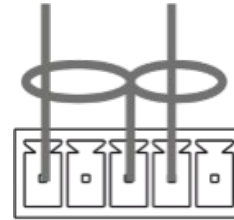

L+ L- G R+ R-

Figure 5: Connecting to an Unbalanced Stereo Audio Acceptor

Connecting to MTX3-88-SE via RS-232

You can connect to **MTX3-88-SE** via an RS-232 connection using, for example, a PC.

MTX3-88-SE features an RS-232 3-pin terminal block connector allowing the RS-232 to control **MTX3-88-SE**.

Connect the RS-232 terminal block on the rear panel of **MTX3-88-SE** to a PC/controller, as follows:

From the RS-232 9-pin D-sub serial port connect:

- Pin 2 to the TX pin on the **MTX3-88-SE** RS-232 terminal block
- Pin 3 to the RX pin on the **MTX3-88-SE** RS-232 terminal block
- Pin 5 to the G pin on the **MTX3-88-SE** RS-232 terminal block

RS-232 Device

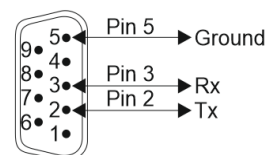

MTX3-88-SE

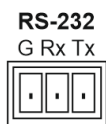

Operating and Controlling the MTX3-88-SE

Principles of Operation

This section covers the following topics:

- [Matrix Operation Modes](#) on page [11](#).
- [Routing IP-Driven Control Signals via Built-in Control Gateway](#) on page [11](#).

Matrix Operation Modes

MTX3-88-SE has 2 major operation modes:

- Matrix mode – Seamless switching, with clean “cut” transition, of any matrix input to any matrix output. Matrix mode is the default operation mode. Switching operation actions, via panel buttons and webpages, are immediately affecting matrix routing and displayed output signals. For switching operation via matrix web-pages, see [Switching an Input to an Output in the Matrix Mode](#) on page [12](#).
- Multi-View mode – Multiple window layouts for viewing multiple input signals on various output ports, as flexibly set via matrix management web pages, and operated by end user via control. Multi-view mode and selected windows layout settings and activation is done via the embedded web pages, control, or matrix panel buttons. Windows layout settings are applicable for displayed output signals during related multi-view layout activation only. For multi-view windows layout settings, see [Selecting a Windows Layout in the Multi-View Mode](#) on page [12](#).

Routing IP-Driven Control Signals via Built-in Control Gateway

Remote IP connected clients can send from the LAN, via the **MTX3-88-SE** matrix built-in control gateway, RS-232 commands, and receive responses and notifications, to control devices connected to **MTX3-88-SE** matrix RS-232 control port. The built-in control gateway sends the control commands (converted from the client received IP messages) to the connected controlled devices, and distributes the responses received from the connected controlled devices to all connected clients.

Built-in control gateway setting is done via the **MTX3-88-SE** matrix control gateway webpages.

Operating the Device using the Device Panel Buttons

Perform the following actions using the front and rear panel buttons:

- [Using Front and Rear Panel Buttons](#) on page [12](#).
- [Switching an Input to an Output in the Matrix Mode](#) on page [12](#).

- [Selecting a Windows Layout in the Multi-View Mode](#) on page [12](#).
- [Storing and Recalling an Operation Preset](#) on page [13](#).
- [Configuring IR and RS-232 over HDBT](#) on page [14](#).

Using Front and Rear Panel Buttons

MTX3-88-SE front and rear panel buttons enable the following actions:

- Routing an INPUT to an OUTPUT in Matrix Mode.
- Selecting from one of the Multi-View Mode Configurations
- Configuring the IR and RS-232 operation mode
- Storing and Recalling a Preset

Switching an Input to an Output in the Matrix Mode

The **MTX3-88-SE** matrix mode is the default operation mode. Any of the 8 inputs can be switched to any of the 8 outputs. Switching is immediate and seamless see [Connecting MTX3-88-SE](#) on page [9](#).



If you're in MULTI-VIEW, (one of the MULTI-VIEW buttons are lit) press any lit MULTI-VIEW button to return to Matrix mode.

To switch an input to an output via the front panel buttons:



1. Verify that the matrix mode **8x8 matrix** indication is activated. For further details (see [Selecting the Desired Operation Mode](#) on page [24](#))
2. On the front panel, press an output and then an input, or multiple inputs, to switch to the selected output.
3. Selected inputs are switched to the output.



Selecting a Windows Layout in the Multi-View Mode

Select the multi-view windows layout, which activates the matrix multi-view mode too. Multiple windows, on multiple output ports, view multiple input signals, as associated to each layout window via the embedded web pages settings.

To select the windows layout in multi-view mode:

1. Press a multi-view front panel button to set one- of the following multi-view mode window layouts:

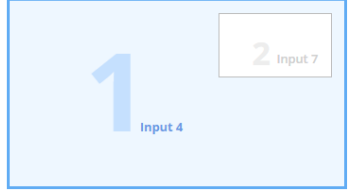
Press	Function Name and Description	Active Multi-View Ports Display	Inactive Output Ports	Displayed Multi-View Windows Layout Output
	<p>QUAD</p> <p>MTX3-88-SE operates as an 8X2 seamless multi-view matrix, with a quad-</p>	Output ports 1 and 5 display four equal-size windows each.	Video output signals are ceased on 2-4 and 6- 8 output ports.	

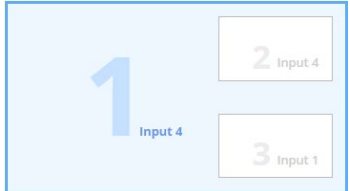
Press	Function Name and Description	Active Multi-View Ports Display	Inactive Output Ports	Displayed Multi-View Windows Layout Output
	windows layout on each relevant output.			
	<p>PIP 1</p> <p>MTX3-88-SE displays multiple dual-windows PIP view on each relevant output, inserting picture 2 as overlaid smaller window over picture 1 larger window appearance.</p>	Odd output ports 1,3,5,7 display dual-windows PIP view.	Video output signals are ceased on 2,4,6,8 even output ports.	
	<p>PIP 2</p> <p>MTX3-88-SE operates as an 8X2 seamless multi-view matrix, with a triple-windows PIP layout on each relevant output, inserting pictures 2 and 3 as overlaid smaller windows over picture 1 larger window appearance.</p>	Output ports 1 and 5 display triple-windows PIP view.	Video output signals are ceased on 2-4 and 7-8 output ports.	



The input signals, viewed in each multi-view windows layout, are set by default as follows: Input 1 to Window 1, Input 2 to Window 2, Input 3 to Window 3 and Input 4 to Window 4. Assigning a different input to a window association is via the embedded web pages (see [Multi-View Operation Mode Settings](#) on page [27](#))

Storing and Recalling an Operation Preset

Store and recall operation presets via the INPUT selection front panel buttons or via the P3K commands (see [Protocol 3000 Commands](#) on page [64w](#)).

Input selection buttons 1 to 8 can store 8 matrix operation presets, which can be recalled when needed.

Each operation preset stores:

- The AV Routing configuration.
- The matrix operation mode (matrix or multi-view operation modes).
- Video output signals saturation, contrast and brightness.
- Output displays borders, labels and their properties (for example, color and background color).
- Audio output signals settings (for example, mute state and volume settings).



Last active operation preset is recalled following power up.

Storing an Operation Preset

You can store 4 operation presets via the front panel input selection buttons (1 to 4).

To store an operation preset:

1. Set the matrix to the desired operation preset configuration.
2. Press **STO**. The STO button lights.
3. Press a storing input button (1 to 4).

The operation preset configuration is stored on the selected input button.

Recalling an Operation Preset

You can recall a stored operation preset from any of the 4 front panel input selection buttons (1 to 4).

To recall an operation preset:

1. Press **RCL**. The RCL button lights.
2. Press an input selection button (1 to 4) to select the desired operation preset configuration.

The device will perform reset, and the selected operation preset is recalled and activated.

Configuring IR and RS-232 over HDBT

Use the DIP switches together with the Data Routing webpage to configure the routing path for extending RS-232 and IR over the HDBT.

See ([Figure 6](#)): Each of the RS-232 and IR data signals may be configured for extension between HDBT (RJ-45) ports (⑫ and ⑮), or between an

HDBT port (⑫ or ⑮), and a panel (Terminal Block) port (⑭) .



The rear panel SETUP DIP-switches functions are described in [Setting the DIP-Switches](#) on page 60.

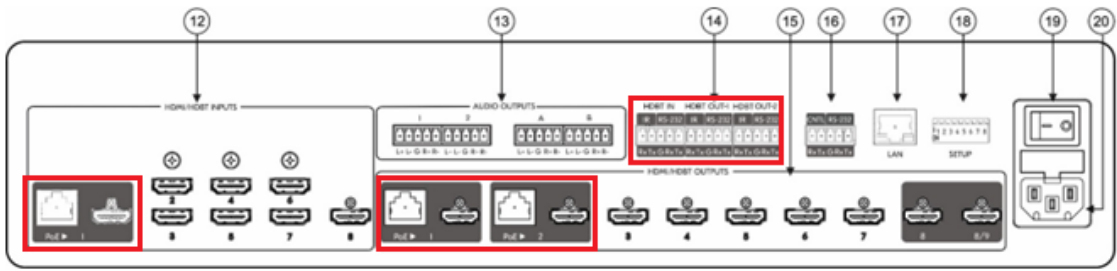

Figure 6: Rear Panel Highlighting HDBT Channel and Port

The figure below explains the co-dependent relationship between the DIP switch configurations and the web selection (see [Data Routing](#) on page 42) for both RS-232 and IR Routing.

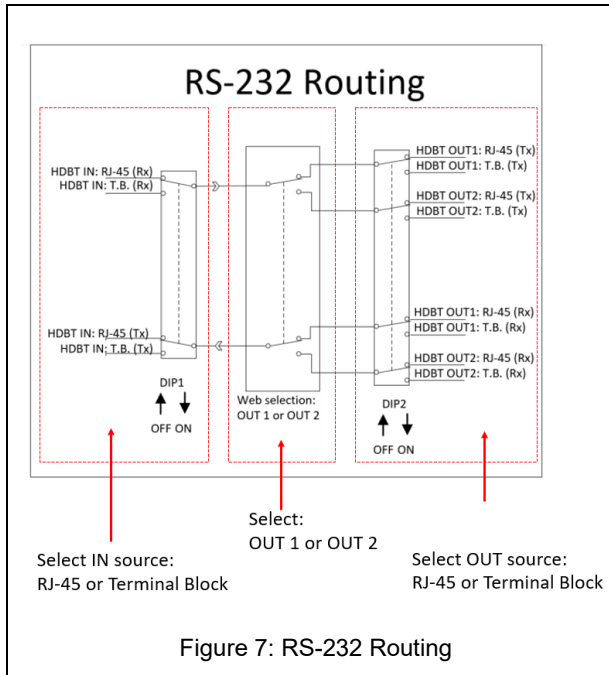

Figure 7: RS-232 Routing

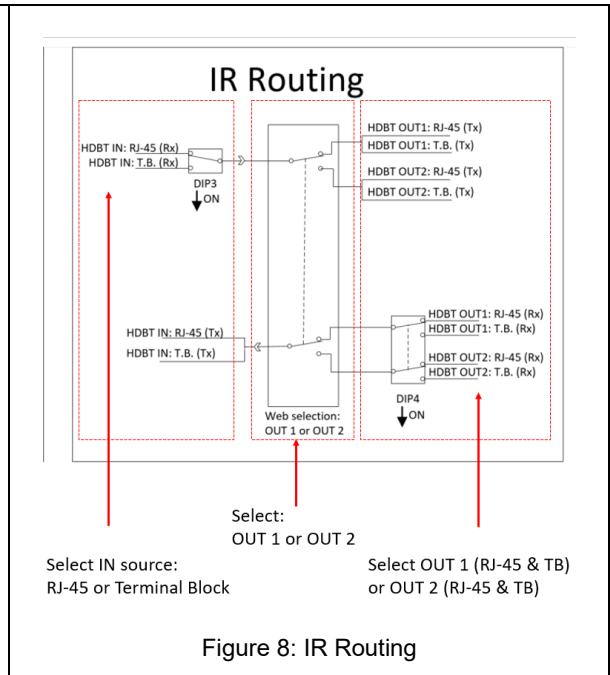
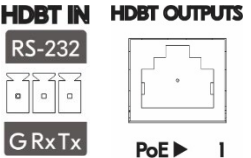
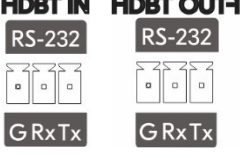
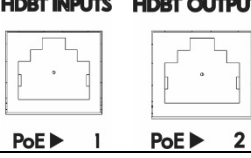
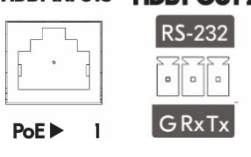

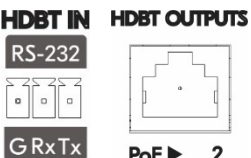
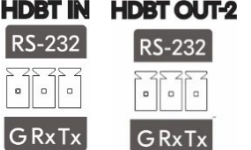

Figure 8: IR Routing





Configuring RS-232 Extension

Dip Switch Configuration and Webpage Selection				Routing
Switch 1	Switch 2	Configuration	Web Selection	
OFF	OFF	HDBT INPUTS HDBT OUTPUTS PoE ▶ I PoE ▶ I	OUT 1 	HDBT IN (RJ-45) is routed to/from HDBT OUT1 (RJ-45)
OFF	ON	HDBT INPUTS HDBT OUT-1 PoE ▶ I RS-232 GRxTx	HDBT ▼ 	HDBT IN (RJ-45) is routed to/from HDBT OUT1 (Terminal Block)

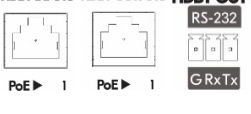
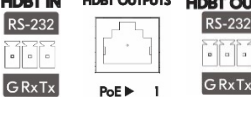
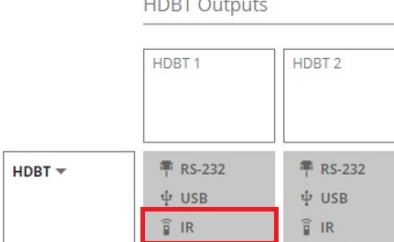
Dip Switch Configuration and Webpage Selection				Routing
Switch 1	Switch 2	Configuration	Web Selection	
ON	OFF	HDBT IN HDBT OUTPUTS 		HDBT IN (Terminal Block) is routed to/from HDBT OUT1 (RJ-45)
ON	ON	HDBT IN HDBT OUT-1 		HDBT IN (Terminal Block) is routed to/from HDBT OUT1 (Terminal Block)
OFF	OFF	HDBT INPUTS HDBT OUTPUTS 	OUT 2	HDBT IN (RJ-45) is routed to/from HDBT OUT2 (RJ-45)
OFF	ON	HDBT INPUTS HDBT OUT-2 		HDBT IN (RJ-45) is routed to/from HDBT OUT2 (Terminal Block)
ON	OFF	HDBT IN HDBT OUTPUTS 		HDBT IN (Terminal Block) is routed to/from HDBT OUT2 (RJ-45)
ON	ON	HDBT IN HDBT OUT-2 		HDBT IN (Terminal Block) is routed to/from HDBT OUT2 (Terminal Block)

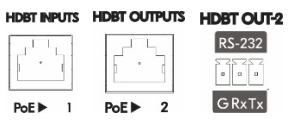
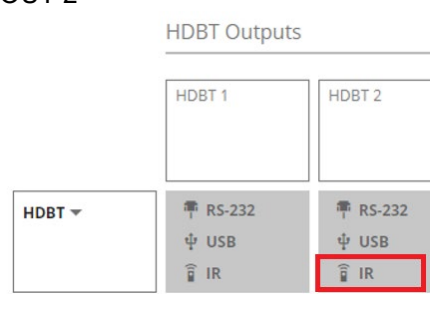
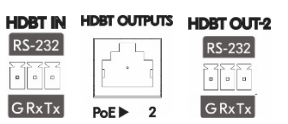
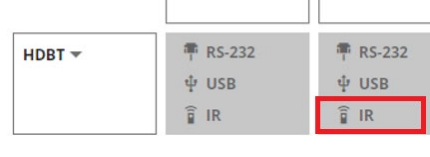
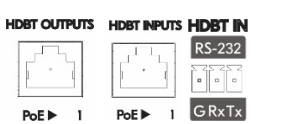
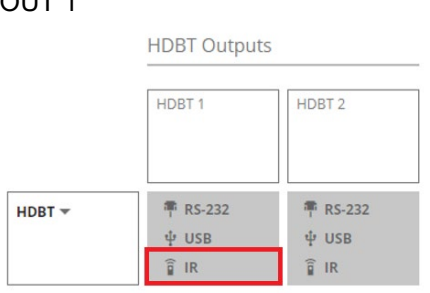
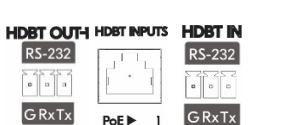
Configuring IR Extension

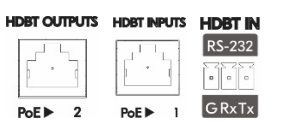
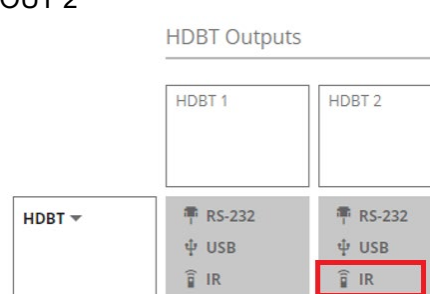
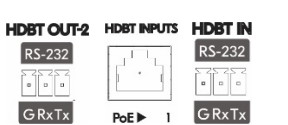
Dip Switch Configuration and Webpage Selection				Routing
Switch 3	Switch 4	Configuration	Web Selection	
OFF	-	HDBT INPUTS HDBT OUTPUTS HDBT OUT-1 	OUT 1	HDBT IN Rx (RJ-45) is routed to HDBT OUT1 Tx (RJ-45 and Terminal Block)
ON	-	HDBT IN HDBT OUTPUTS HDBT OUT-1 		HDBT IN Rx (Terminal Block) is routed to HDBT OUT1 Tx (RJ-45 and Terminal Block)

Dip Switch Configuration and Webpage Selection				Routing
Switch 3	Switch 4	Configuration	Web Selection	
OFF	-		OUT 2 	HDBT IN Rx (RJ-45) is routed to HDBT OUT2 Tx (RJ-45 and Terminal Block)
ON	-			HDBT IN Rx (Terminal Block) is routed to HDBT OUT2 Tx (RJ-45 and Terminal Block)
-	OFF		OUT 1 	HDBT OUT1 Rx (RJ-45) is routed to HDBT IN Tx (RJ-45 and Terminal Block)
-	ON			HDBT OUT1 Rx (Terminal Block) is routed to HDBT IN Tx (RJ-45 and Terminal Block)
-	OFF		OUT 2 	HDBT OUT2 Rx (RJ-45) is routed to HDBT IN Tx (RJ-45 and Terminal Block)
-	ON			HDBT OUT2 Rx (Terminal Block) is routed to HDBT IN Tx (RJ-45 and Terminal Block)

Operating via Ethernet

- [Connecting Ethernet Port Directly to a PC](#) on page [18](#).
- [Connecting Ethernet Port via a Network Switch](#) on page [20](#).
- [Configuring Ethernet Port](#) on page [20](#).
- [Discovering and acquiring IP address](#) on page [20](#).

You can connect to **MTX3-88-SE** via Ethernet using either of the following methods:

- Directly to the PC using a crossover cable (see [Connecting Ethernet Port Directly to a PC](#) on page [18](#)).
- Via a network switch or router, using a straight-through cable (see [Connecting Ethernet Port via a Network Switch](#) on page [20](#)).



If you want to connect via a router and your IT system is based on IPv6, speak to your IT department for specific installation instructions.

Connecting Ethernet Port Directly to a PC

You can connect the Ethernet port of **MTX3-88-SE** directly to the Ethernet port on your PC using a crossover cable with RJ-45 connectors.



This type of connection is recommended for identifying **MTX3-88-SE** with the factory configured default IP address.

After connecting **MTX3-88-SE** to the Ethernet port, configure your PC as follows:

1. Click **Start > Control Panel > Network and Sharing Center**.
2. Click **Change Adapter Settings**.
3. Highlight the network adapter you want to use to connect to the device and click **Change settings of this connection**.

The Local Area Connection Properties window for the selected network adapter appears as shown in ([Figure 9](#)).

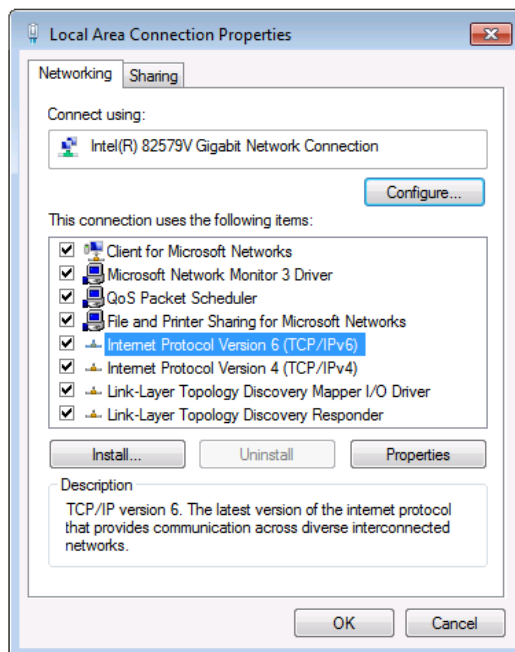

Figure 9: Local Area Connection Properties Window

4. Highlight either **Internet Protocol Version 6 (TCP/IPv6)** or **Internet Protocol Version 4 (TCP/IPv4)** depending on the requirements of your IT system.

5. Click **Properties**.

The Internet Protocol Properties window relevant to your IT system appears as shown in [\(Figure 10\)](#).

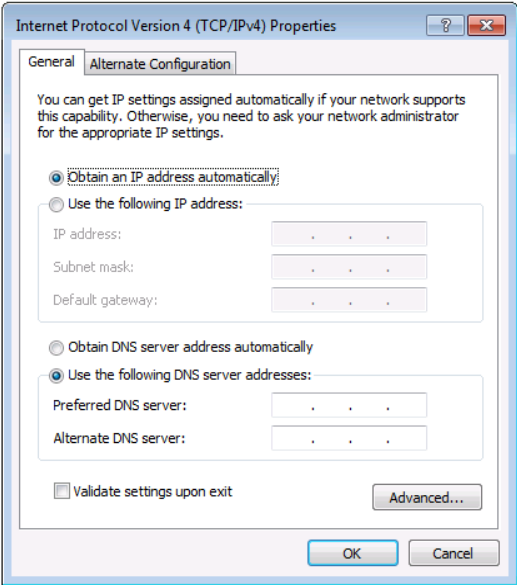

Figure 10: Internet Protocol Version 4 Properties Window

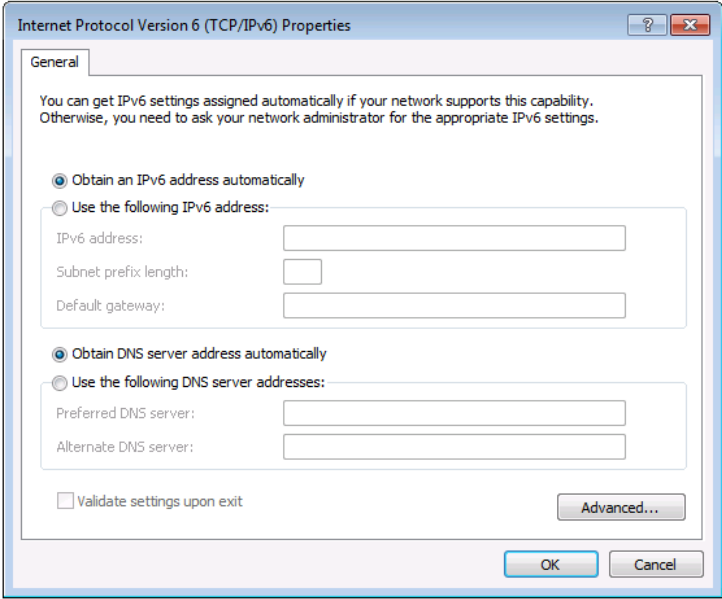

Figure 11: Internet Protocol Version 6 Properties Window

6. Select **Use the following IP Address** for static IP addressing and fill in the details as shown in (Figure 12).
For TCP/IPv4 you can use any IP address in the range 192.168.1.1 to 192.168.1.255 (excluding default 192.168.1.39 fallback address) that is provided by your IT department.

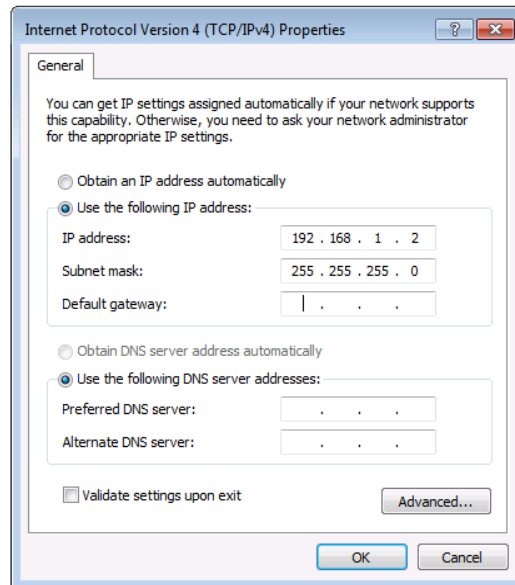

Figure 12: Internet Protocol Properties Window

7. Click **OK**.
8. Click **Close**.

Connecting Ethernet Port via a Network Switch

You can connect the Ethernet port of **MTX3-88-SE** to the Ethernet port on a network switch or router using a straight-through cable with RJ-45 connectors.

Configuring Ethernet Port

You can set the Ethernet parameters via the embedded Web pages.

Discovering and acquiring IP address

MTX3-88-SE includes IP address auto-acquiring policy via LAN-connected DHCP server by default. When no DHCP server is detected, a fallback static IP address of 192.168.1.39, and 255.255.255.0 subnet mask (class C), is assigned until an IP address is acquired via the DHCP server.

For more information, refer to Product Page Technical Note in www.kramerav.com/product/MTX3-88-SE.

Using Embedded Web Pages

MTX3-88-SE can be operated remotely using the embedded Web pages. The Web pages are accessed using a Web browser and an Ethernet connection.

Before attempting to connect:

- Perform the procedures in [Operating via Ethernet](#) on page [17](#).
- Ensure that your browser is supported.

The following operating systems and Web browsers are supported:

Operating Systems	Browser
Windows 7	Chrome
Windows 10	Edge
	Chrome
Mac	Safari
iOS	Safari
Android	N/A



If a web page does not update correctly, clear your Web browser's cache.



Check that Security/firewalls are not blocking HTTP traffic between the device and the user PC.

To access the web pages:

1. Enter the IP address of the device in the address bar of your internet browser (default = 192.168.1.39).

If security is enabled, the Login window appears.

Figure 13: Embedded Web Pages Login Window

- 2. Enter the Username (default = Admin) and Password (default = Admin) and click **Sign in**. The default web page appears.

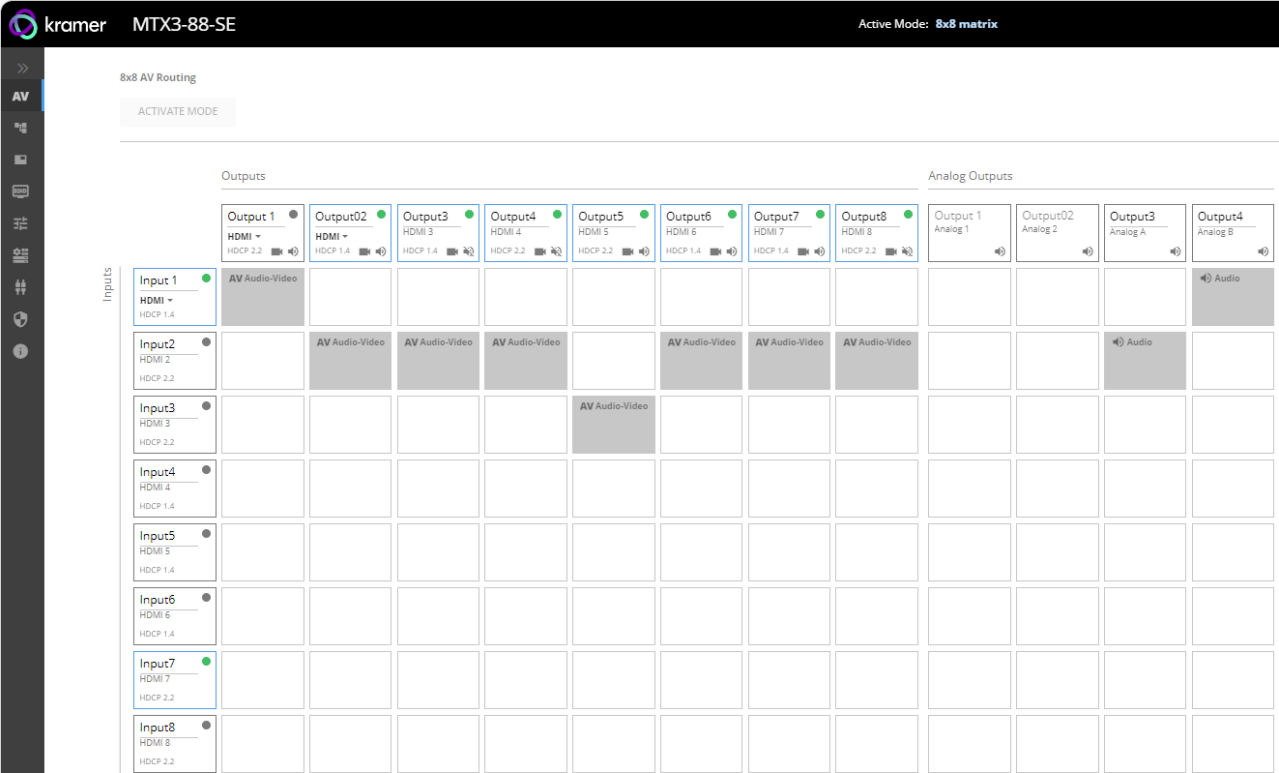

Figure 14: AV Landing Page

- Click the arrow at the top of the navigation list to view the menu items in detail.

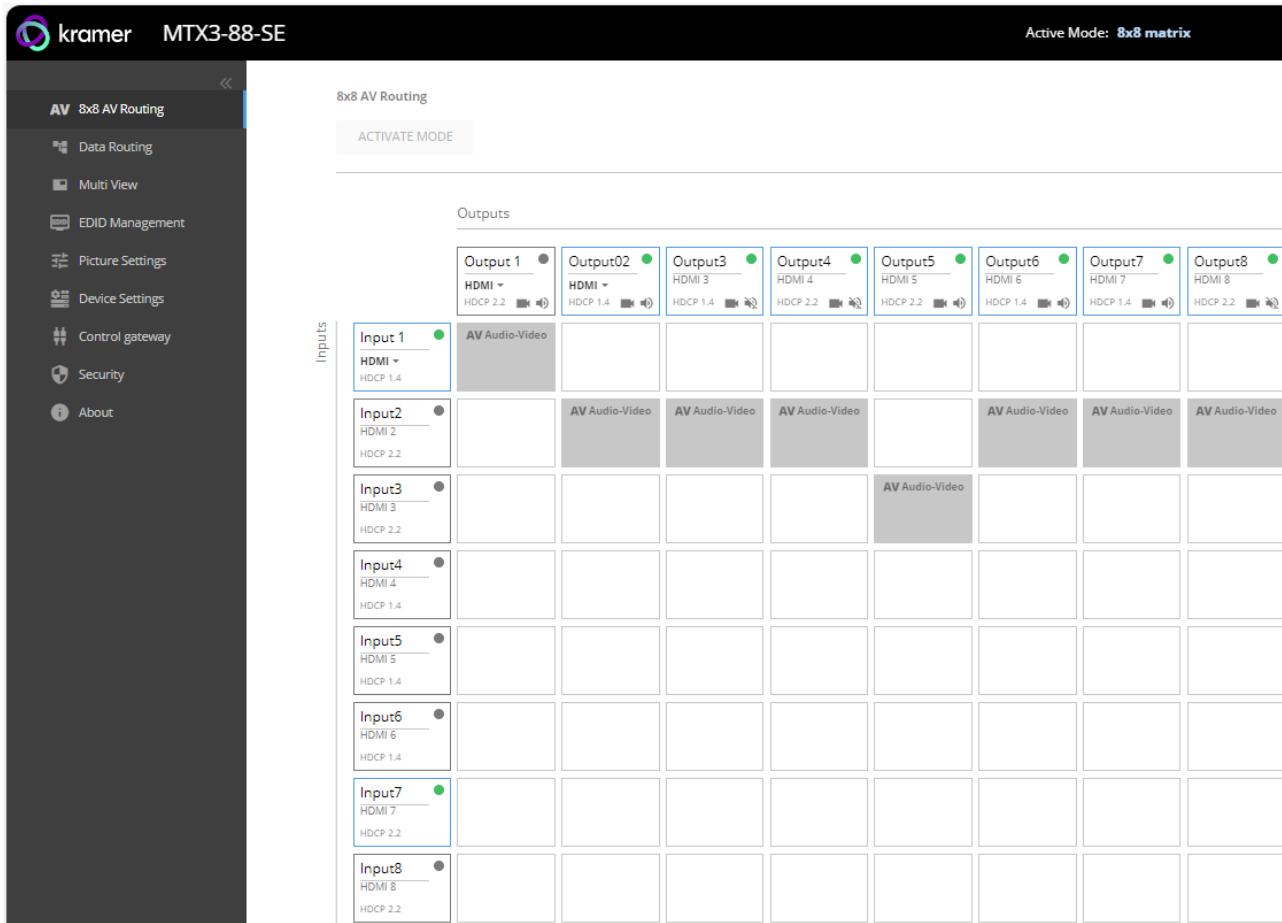

Figure 15: Navigation Pane Details View

- Click the Navigation Pane on the left side of the screen to access the relevant web page.

MTX3-88-SE web pages enable performing the following actions:

- [8x8 AV Matrix Routing Operation and Settings](#) on page [24](#)
- [Multi-View Operation Mode](#) Settings on page [27](#).
- [Data Routing](#) on page [42](#).
- [Managing EDID](#) on page [44](#).
- [Picture Settings](#) on page [46](#).
- [Setting Device Properties](#) on page [49](#).
- [Setting Control Gateway Properties](#) on page [53](#).
- [Setting Security Status](#) on page [54](#).
- [Viewing the About Page](#) on page [59](#).

8x8 AV Matrix Routing Operation and Settings

For the 8X8 AV Matrix mode, the following actions can be performed:

- [Selecting the Desired Operation Mode](#) on page [24](#).
- [Switching Inputs to Outputs](#) on page [25](#).
- [Adjusting Input and Output Port Settings](#) on page [27](#).

Selecting the Desired Operation Mode

Use the Navigation List to select the desired active operation mode.

To select the active operation mode:

1. Click the desired operation mode on the Navigation List:
 - Select the desired operation page from either **8x8 AV Routing** (for matrix mode) or **Multi View** (for multi-view mode) pages. The selected operation and settings page of the desired operation mode appears ([Figure 14](#) or [Figure 23](#))
2. In the selected page top left, click **ACTIVATE MODE** to activate the current active operation mode.
 - The desired operation mode is activated and ACTIVATE MODE button is grayed out.
 - The current Active Operation Mode is displayed in the top menu bar as either one of:
 - **8x8 AV Routing** (for matrix mode)
 - **Multi View** (for multi-view mode)

The active operation mode is selected.

To verify the matrix operation mode is the active mode:

- On the Av Routing (Matrix) operation page ([Figure 16](#)), verify:
 - In the top menu bar, **8x8 matrix** is displayed next to Active Mode.
 - Above the routing grid, **8x8 AV Routing** is displayed above grayed out ACTIVATE MODE button.

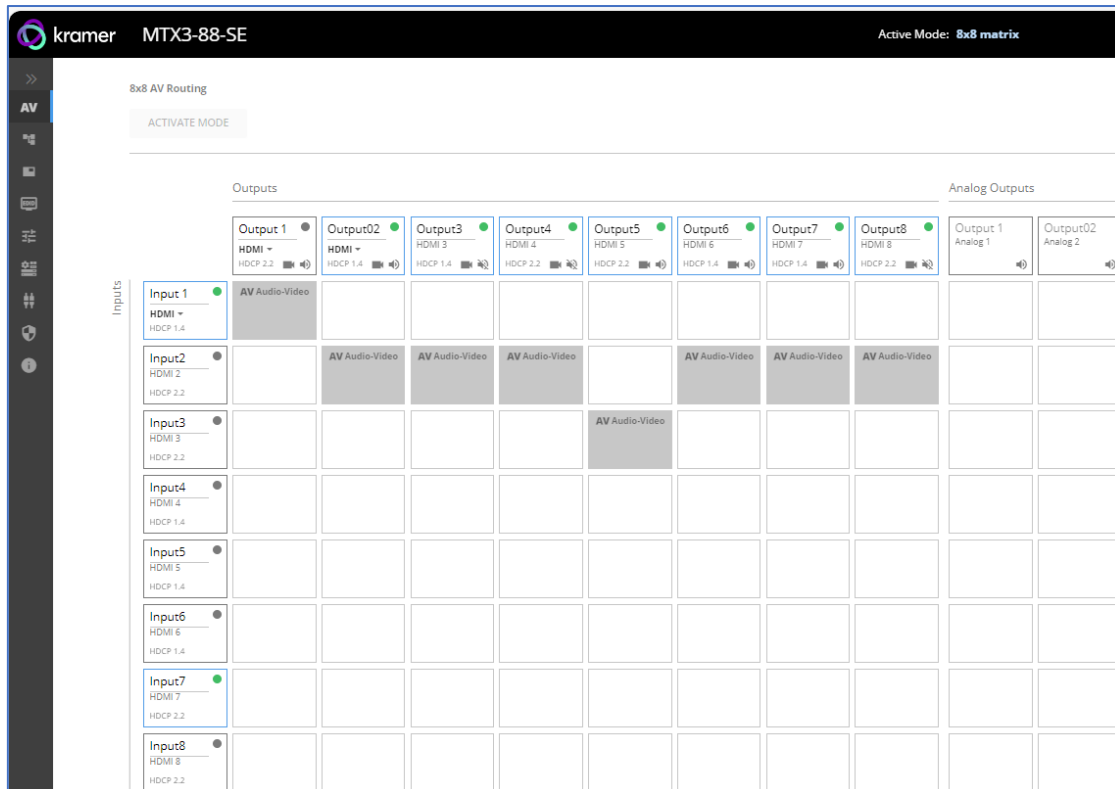

Figure 16: 8X8 AV Routing (Matrix) Operation Selected

In the matrix operation mode, route the inputs to the outputs (see [Switching Inputs to Outputs](#) on page [25](#)).

Switching Inputs to Outputs

To switch an input to an output:

- Click **8x8 AV Routing** on the Navigation List. The 8x8 AV Routing page appears ([Figure 16](#)).
- Click one or multiple cross-points between inputs and outputs to switch the selected inputs to the selected outputs.



- To select a cross-point, make sure to click the text within the square.



Figure 17: Click Text to Select Cross-Point

- A green light on a button indicates a connected source/acceptor.
- The grid view allows you to select the **Input** to **Output** connections using a simple grid.

- Select a box to connect Input Ports to Output Ports.

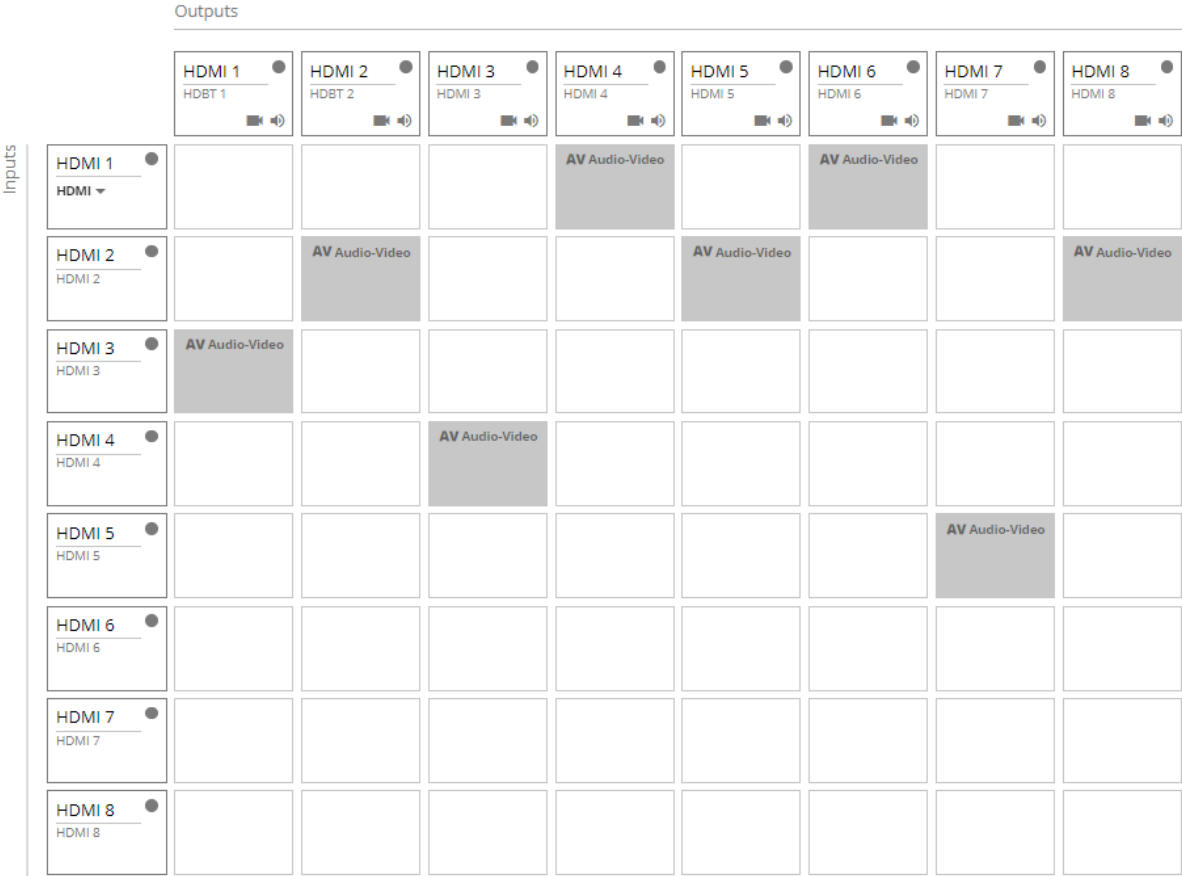

Figure 18: Matrix Grid View

3. If required, do the following:

- Click the desired Port (for example HDMI 7) and edit the port label accordingly.

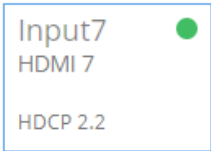







Figure 19: Edit Port Label

- Click  (on output port) to mute the video output signal.  indication appears.
- Click  (on output port) to mute the audio output signal.  indication appears.
- Click  (on Analog Output ports) to adjust the output volume. The following window appears:

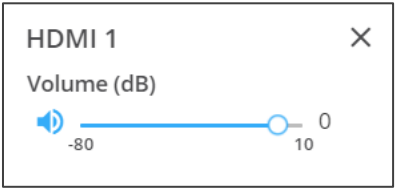

Figure 20: Setting the Output Volume

The selected inputs are switched to the selected outputs.

Adjusting Input and Output Port Settings

- In the navigation list select Picture Settings.
 - To adjust input port settings (see [Adjusting Input Parameters](#) on page 46).
 - To adjust output port settings (see [Adjusting Output Parameters](#) on page 48).



Input and output settings may differ depending on selected mode.

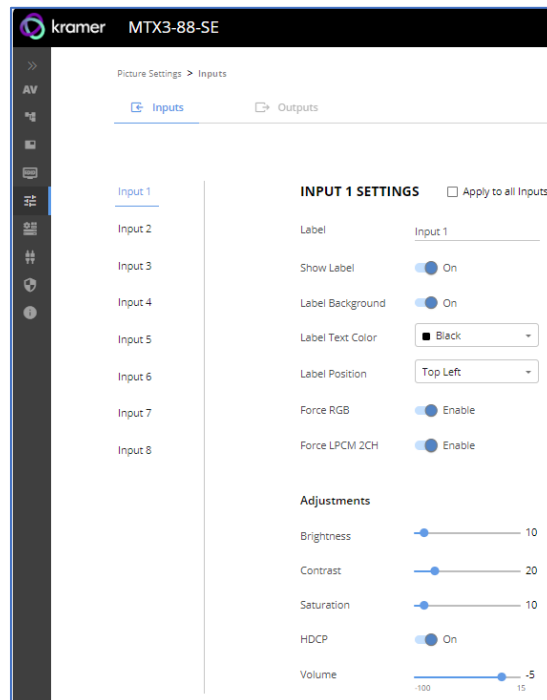

Figure 21: Input Port Settings Page

Multi-View Operation Mode Settings

This Multi-view mode section describes how to select the active windows layout and how to set the multiple viewed windows in various selected layouts.

This section includes performing of the following actions:

- [Selecting Multi-View Mode](#) on page 27.
- [Selecting and Setting the Quad-view Layout](#) on page 28.
- [Selecting and Setting the 1 PiP \(8X4 matrix\) Mode](#) on page 33.
- [Selecting and Setting the 2 PIP \(8X2 matrix\) Mode](#) on page 38

Selecting Multi-View Mode

To select the multi-view mode as the active operation mode, see [Selecting the Desired Operation Mode](#) on page 24.

To verify the multi-view operation mode is the active mode:

- On the Multi-view operation page ([Figure 22](#)), verify:

- In the top menu bar, **8x2** or **8x4** (not 8x8) **matrix with PIP** or **Quadview** is displayed next to Active Mode.
- Above the routing grid, **Multi View** is displayed above grayed out **ACTIVATE MODE** button.

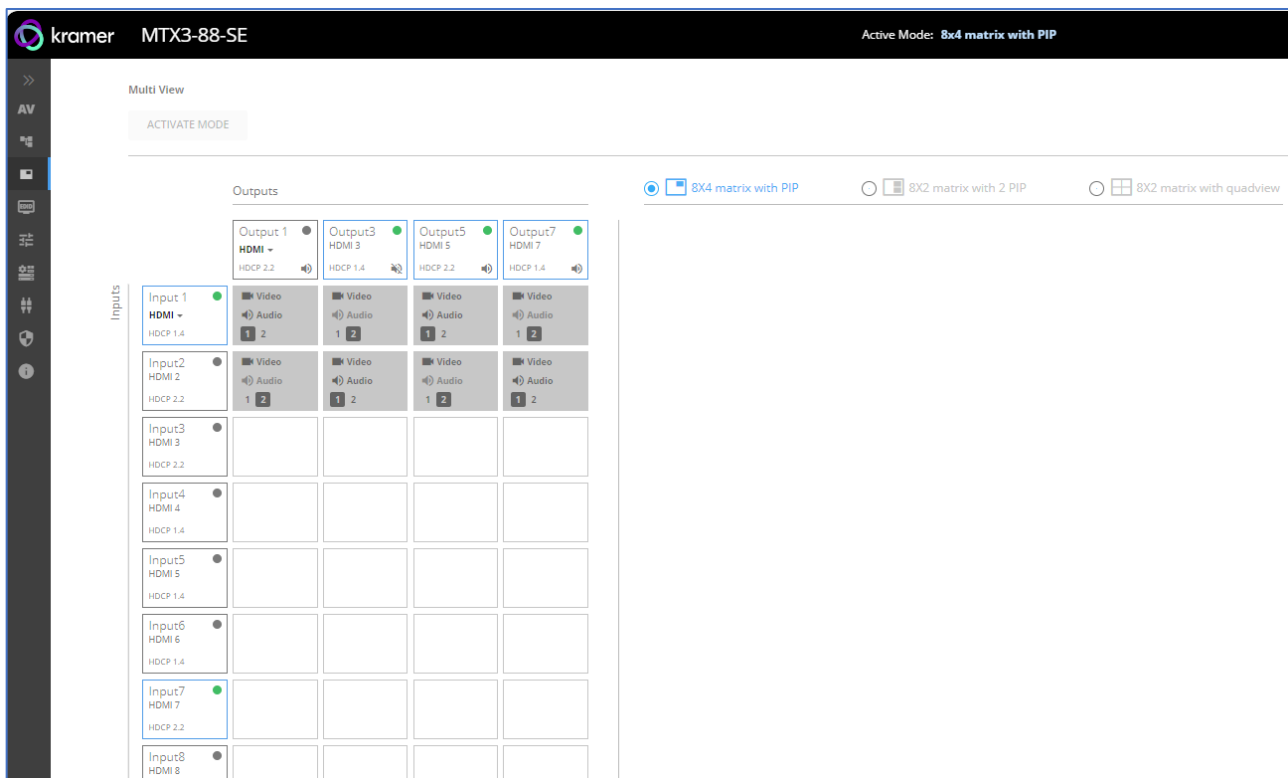

Figure 22: Multi View Operation Mode, 1 PiP Selected

In the Multi-View operation mode, select one of the Multi-View windows layouts (see [Selecting a Windows Layout in the Multi-View Mode](#) on page 12).

Selecting and Setting the Quad-view Layout

The Quadview windows layout page enables performing the following actions:

Selecting the Quad-view layout settings tab

To select the QUAD mode:

1. Click **Multi View** on the Navigation List. The Multi-View Settings page appears ([Figure 22](#)).
2. Select **8x2 matrix with quadview** layout settings tab (see [Selecting a Windows Layout in the Multi-View Mode](#) on page 12). The QUAD layout tab appears ([Figure 23](#)).

3. Click **ACTIVATE MODE**. The page top bar displays the active matrix with selected multi-view layout mode. You are now ready to set your quad-view layout parameters.

Initial page of multi-view mode with **8x2 matrix with quadview** layout settings appears, with matrix routing available active 1 and 5 outputs ([Figure 23](#)).



Layout windows grid appears only after input selection.

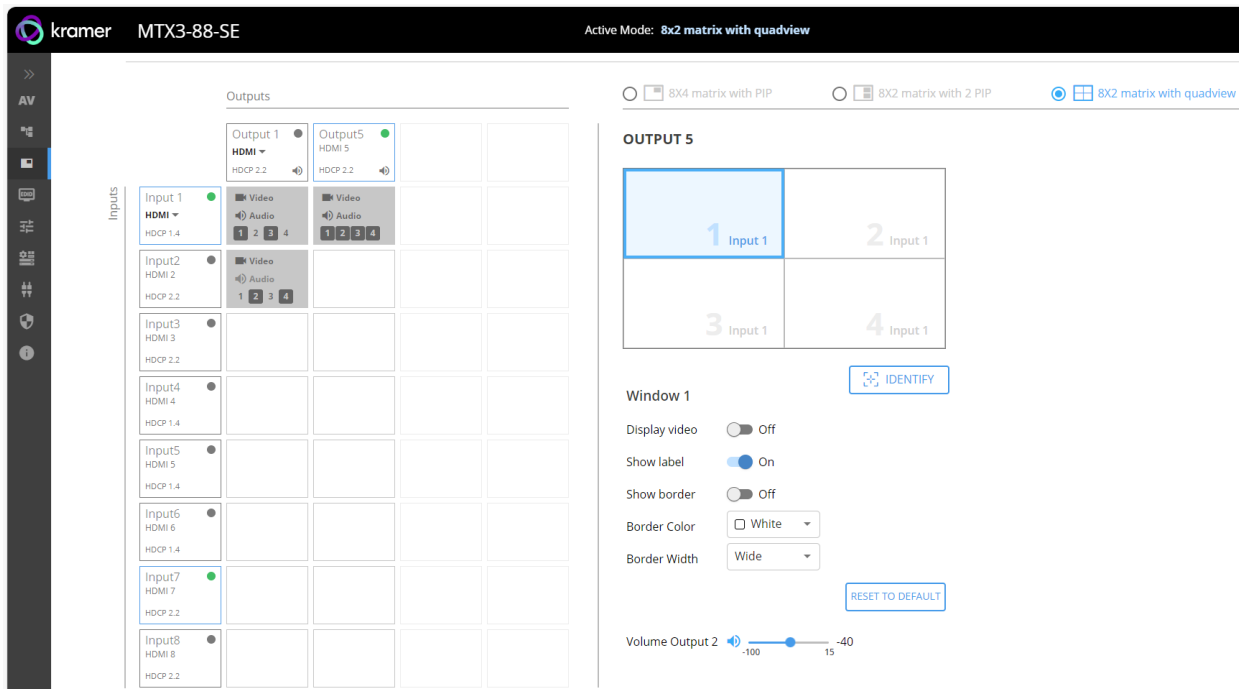
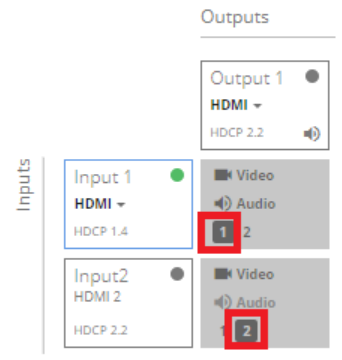
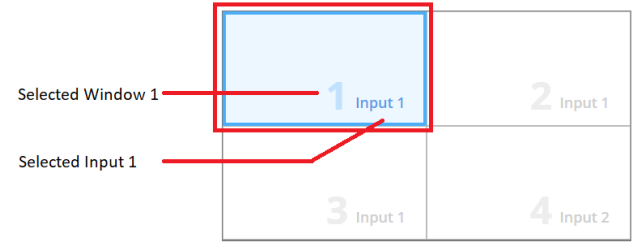
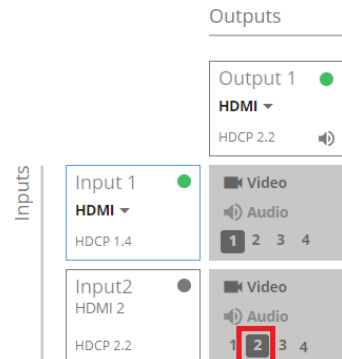
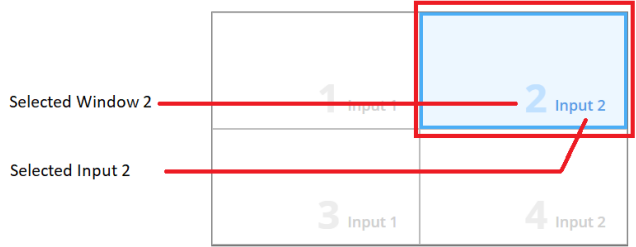
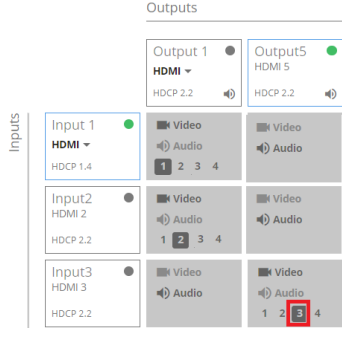
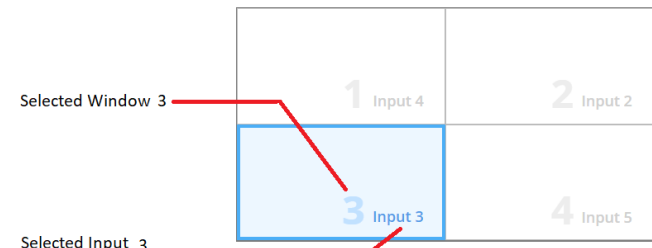
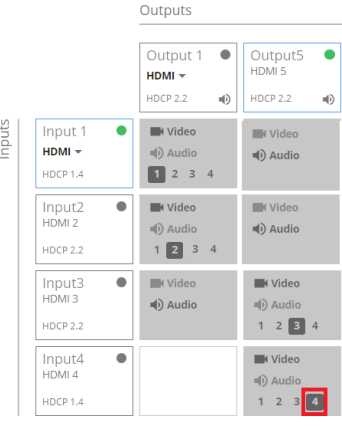
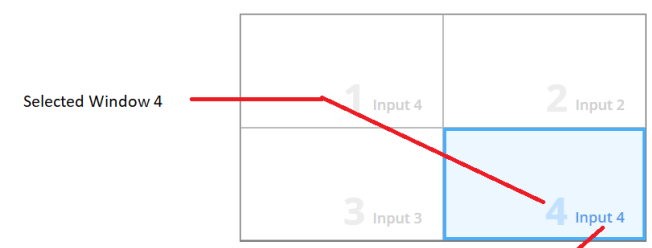

Figure 23: Multi View Mode – 8x2 Matrix with Quadview Layout – Initial Settings Page

Setting inputs to the Quad-view layout windows

1. Select any matrix routing input cross-point box, either for output 1 or 5
 - Quad-view windows grid appears on the right side pane.
 - Selected output number appears above windows grid.
 - Selected input cross-point box appears with 4 windows numbers (1 to 4) to choose the window that this input relates to.
2. For each selected input cross-point box (input 1 to 8), select the input-related window (window 1, 2, 3 or 4)
 - Selected window, in selected output quad-view grid, is blue-border highlighted, with related input number in its bottom right corner.
 - Click the cross-point box and verify that the Input number you select within the box (1-4), is the output you wish to display in the window.

3. Repeat for the 2 active outputs and their remaining windows.

Matrix Routing Input -Output Cross-Point Box	Input	Output	Quad View Windows Grid
	1	1	<p>Selected Output — OUTPUT 1</p>  <p>Selected Window 1</p> <p>Selected Input 1</p> <p>i To define quad-view layouts for Window 1, see Defining Quad-view layout windows on page 32).</p>
	2	1	<p>Selected Output — OUTPUT 1</p>  <p>Selected Window 2</p> <p>Selected Input 2</p> <p>i To define quad-view layouts for Window 2, see Defining Quad-view layout windows on page 32).</p>
	3	5	<p>Selected Output — OUTPUT 5</p>  <p>Selected Window 3</p> <p>Selected Input 3</p> <p>i To define quad-view layouts for Window 3, see Defining Quad-view layout windows on page 32).</p>
	4	5	<p>Selected Output — OUTPUT 5</p>  <p>Selected Window 4</p> <p>Selected Input 4</p> <p>i To define quad-view layouts for Window 4, see Defining Quad-view layout windows on page 32).</p>

- 4. Adjust the audio volume, for each output, using the Volume Output 1, 2 slider, in the grid-pane bottom right-hand side, or manually adjusting the volume level at the slider right side.

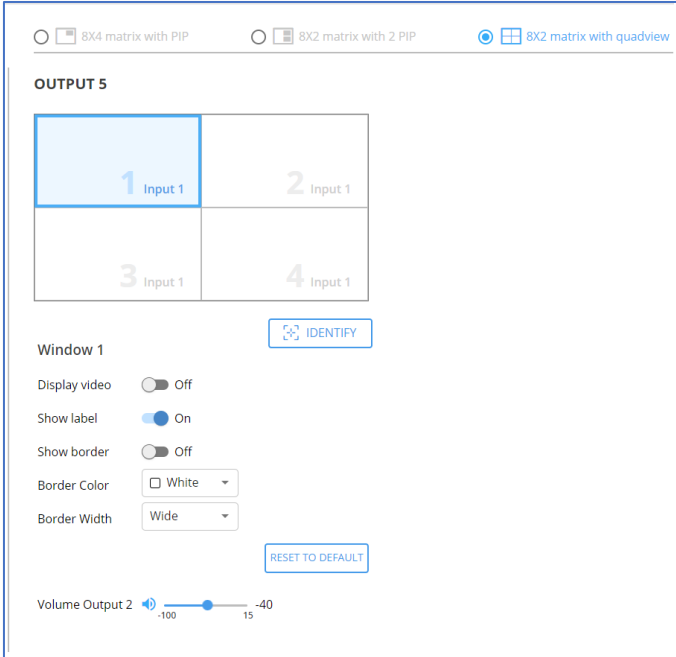

Figure 24: Multi View 8x2 Matrix with Quadview Layout – Adjusting Output Audio Volume

Defining Quad-view layout windows

You can set the parameters for each window separately.

To define a Window:

1. In the right-hand pane, click the desired window (1 to 4).
 - The selected window is shaded blue.
 - The text **Window X** (1-4) appears beneath the quad view layout.
 - All parameters for that window are ready for parameter settings.

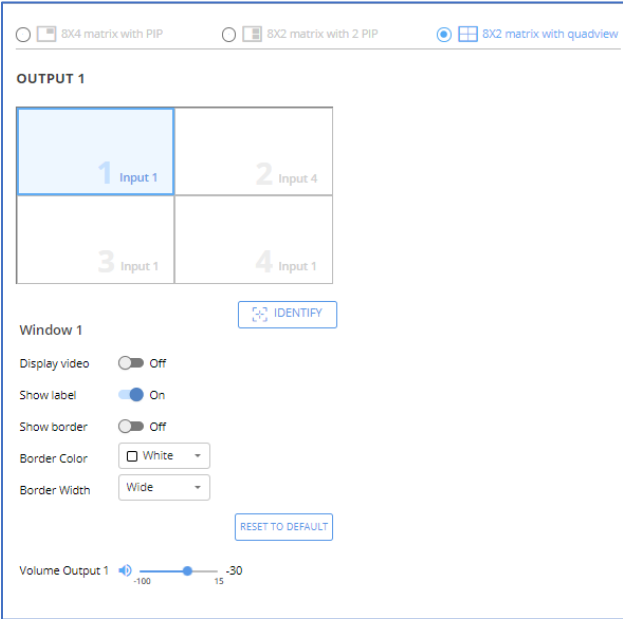

Figure 25: Quad-View Layout – Window 1 Parameters Settings

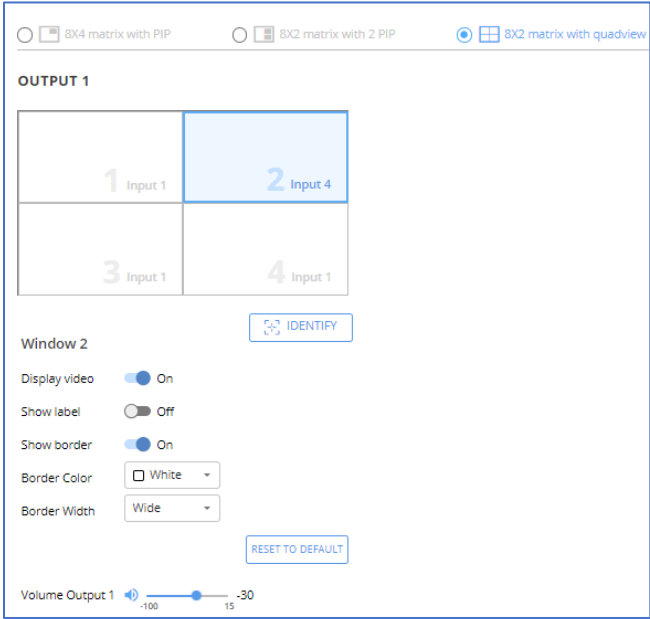

Figure 26: Quad-View Layout – Window 2 Parameters Settings

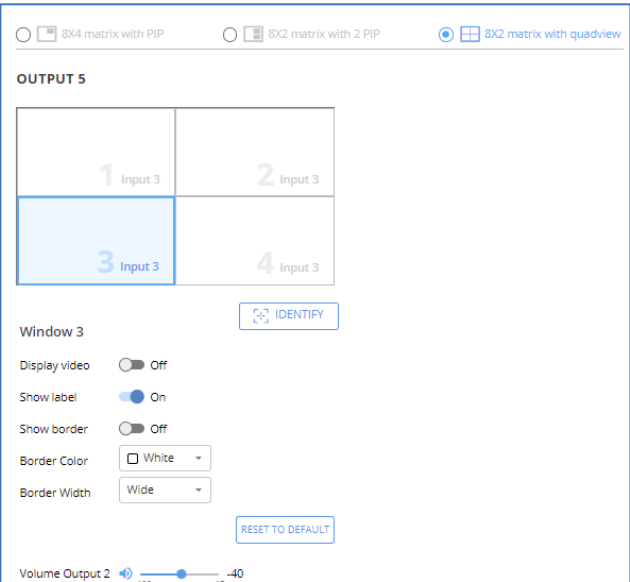

Figure 27: Quad-View Layout – Window 3 Parameters Settings

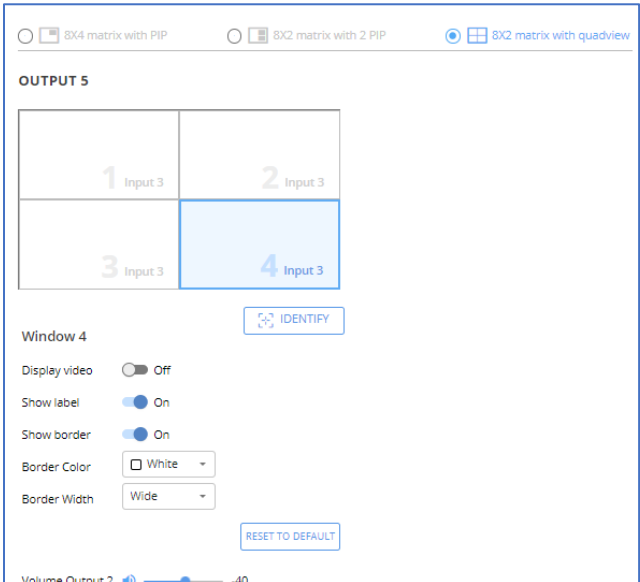

Figure 28: Quad-View Layout – Window 4 Parameters Settings

- Set on/off for display video, show label and border parameters.
- Select border color and width.

2. Click **IDENTIFY** to display each quad-view layout window number on output display via OSD for about 10 seconds.
 3. Click **RESET TO DEFAULT** to reset settings to factory defaults.
- Layout windows settings are defined.

Selecting and Setting the 1 PiP (8X4 matrix) Mode

In the 1 PiP (Picture-in-Picture) mode, one image is displayed over the background image. The 1 PIP mode enables performing the following actions:

Selecting the 1 PIP (8X4 matrix) layout settings tab

To select the 1 PiP (8X4 matrix) mode:

1. Click **Multi View** on the Navigation List. The Multi-View Settings page appears ([Figure 22](#)).
2. Select **8x4 matrix with PIP** layout settings tab (see [Selecting a Windows Layout in the Multi-View Mode](#) on page [12](#)). The 8x4 matrix with PIP layout tab appears ([Figure 29](#)).
3. Click **ACTIVATE MODE**. The page top bar displays the active matrix with selected multi-view layout mode. You are now ready to set your **1 PIP (8X4 matrix)** layout parameters.

Initial page of multi-view mode with **8x4 matrix with PIP** layout settings appears, with matrix routing available active 1, 3, 5 and 7 outputs ([Figure 29](#)).



Layout windows grid appears only after input selection.

The screenshot displays the 'Multi View' settings interface. At the top, there is an 'ACTIVATE MODE' button. Below it, the 'Outputs' section shows four columns: Output 1 (HDMI 1), Output 3 (HDMI 3), Output 5 (HDMI 5), and Output 7 (HDMI 7). The 'Inputs' section on the left shows eight rows: Input 1 (HDMI 1), Input 2 (HDMI 2), Input 3 (HDMI 3), Input 4 (HDMI 4), Input 5 (HDMI 5), Input 6 (HDMI 6), Input 7 (HDMI 7), and Input 8 (HDMI 8). The '8x4 matrix with PIP' layout is selected, and the 'OUTPUT 1' window is shown with a large '1' and 'Input 1' label. The 'IDENTIFY' button is visible. The 'Window 1' settings are: Display video (On), Show label (On), Show border (Off), Border Color (White), Border Width (Wide), and Volume Output 1 (-100).

Figure 29: Multi View Mode – 8x4 Matrix with PIP Layout – Initial Settings Page

Setting inputs for the 1 PIP (8X4 matrix) view layout windows

1. Select any matrix routing input cross-point box, either for output 1,3,5, or 7.
 - Quad-view windows grid appears on the right side pane.
 - Selected output number appears above the windows grid.
 - Selected input cross-point box appears with 2 windows numbers (1, 2) to choose the window that this input relates to.
2. For each selected input cross-point box (input 1 to 8), select the input-related window (window 1, or 2).
 - Selected window, in selected output quad-view grid, is blue-border highlighted, with related input number in its bottom right corner.
 - Click the cross-point box and verify that the Input number you select within the box (1,2), is the output you wish to display in the window.
3. Repeat for the 3 active outputs and their remaining windows.

Input -Output Cross-Point Box	Inputs	Output	Quad View Windows Grid
	1 and 2	1	<p>Selected Input 2</p> <p>Selected Window 2</p> <p>Selected Output OUTPUT 1</p> <p>Selected Window 1</p> <p>Selected Input 1</p> <p>i To define quad-view layouts for Window 1, see Defining Quad-view layout windows on page 32.</p>

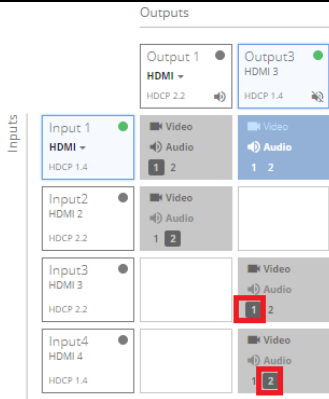
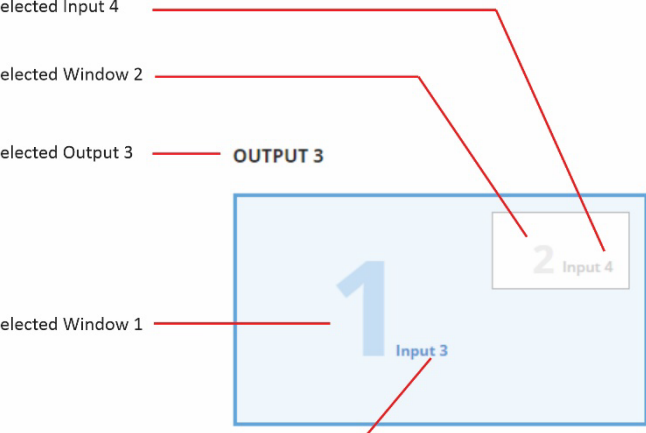
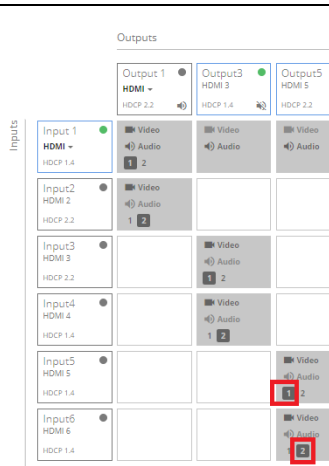
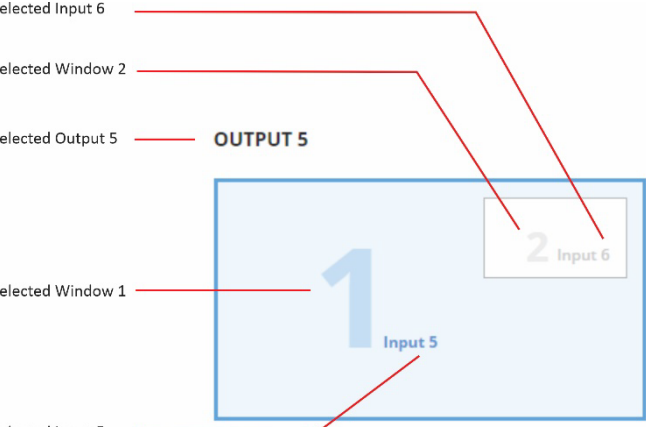
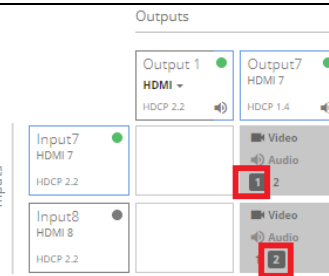
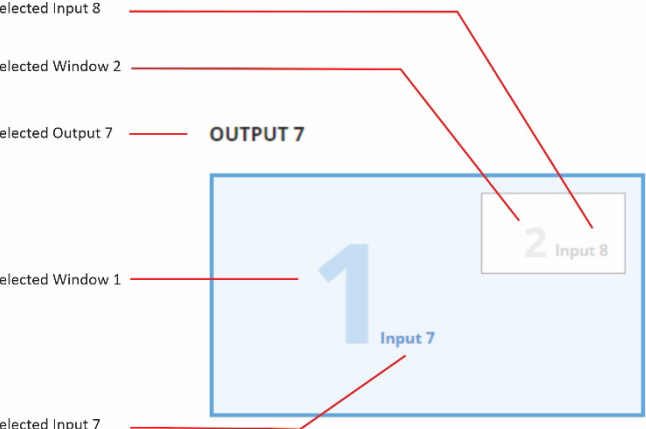
Input -Output Cross-Point Box	Inputs	Output	Quad View Windows Grid
	<p>3 and 4</p>	<p>3</p>	<p>Selected Input 4</p> <p>Selected Window 2</p> <p>Selected Output 3 — OUTPUT 3</p> <p>Selected Window 1</p> <p>Selected Input 3</p>  <p>i To define quad-view layouts for Window 2, see Defining Quad-view layout windows on page 32).</p>
	<p>5 and 6</p>	<p>5</p>	<p>Selected Input 6</p> <p>Selected Window 2</p> <p>Selected Output 5 — OUTPUT 5</p> <p>Selected Window 1</p> <p>Selected Input 5</p>  <p>i To define quad-view layouts for Window 3, see Defining Quad-view layout windows on page 32).</p>
	<p>7 and 8</p>	<p>7</p>	<p>Selected Input 8</p> <p>Selected Window 2</p> <p>Selected Output 7 — OUTPUT 7</p> <p>Selected Window 1</p> <p>Selected Input 7</p>  <p>i To define quad-view layouts for Window 3, see Defining Quad-view layout windows on page 32).</p>

- 4. Adjust the audio volume, for each output, using the Volume Output 1, 2 slider, in the grid-pane bottom right-hand side, or manually adjusting the volume level at the slider right side.

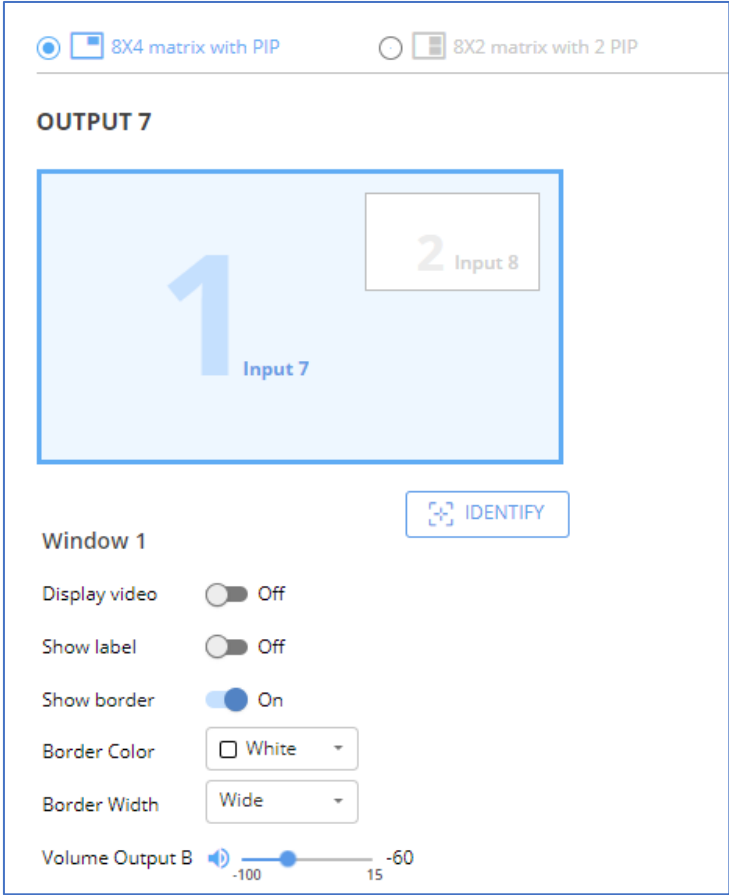

Figure 30: Multi View 8x4 Matrix with Quadview Layout – Adjusting Output Audio Volume

Defining 1 PIP (8X4 matrix) layout windows

You can set the parameters for each window separately.

To define a Window:

- In the right-hand pane, click the desired window (1 or 2).
 - The selected window is shaded blue.
 - The text **Window X** (1 or 2) appears beneath the 1 PIP layout.
 - All parameters for that window are ready for parameter settings.
 - Set on/off for display video, show label and border parameters.
 - Select border color and width.

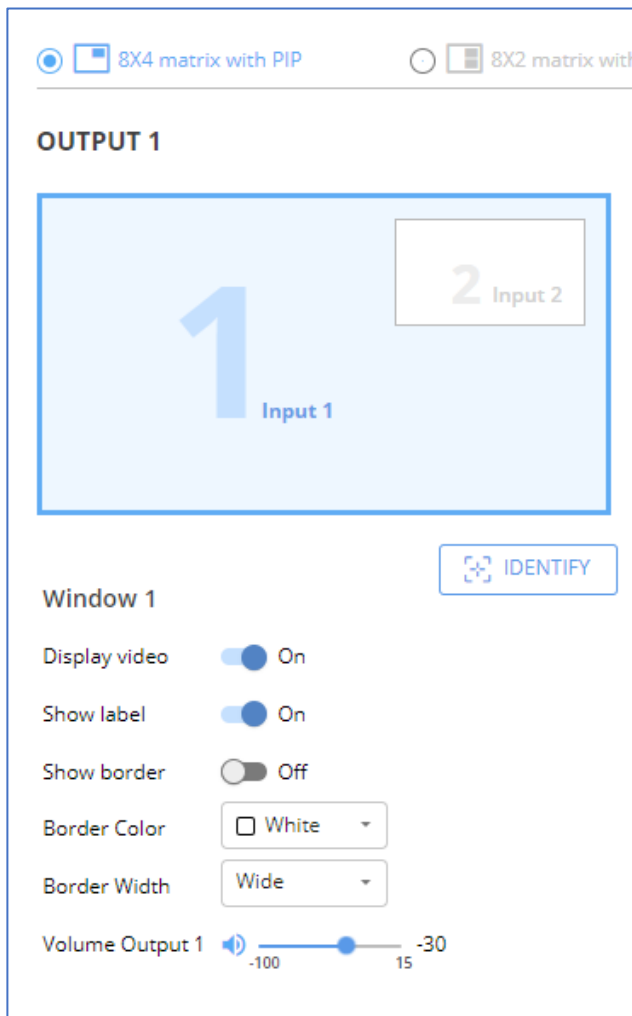

Figure 31: 1 PIP (8X4 matrix) layout – Window 1 parameters settings

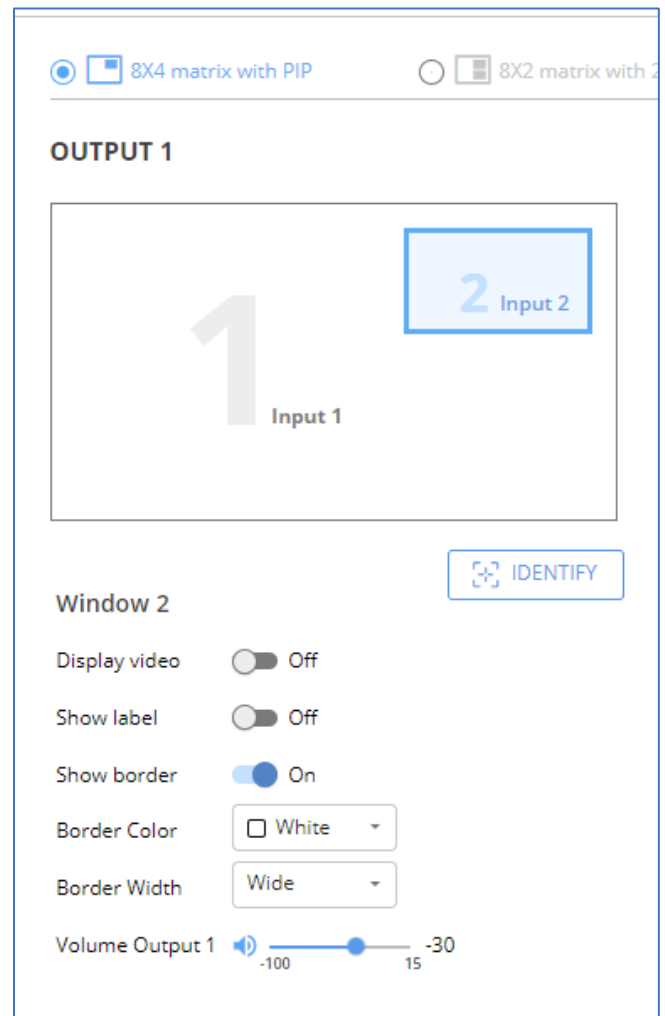

Figure 32: 1 PIP (8X4 matrix) layout – Window 2 parameters settings

- Click **IDENTIFY** to display each quad-view layout window number on output display via OSD for about 10 seconds.
 - Click **RESET TO DEFAULT** to reset settings to factory defaults.
- Layout windows settings are defined.

Selecting and Setting the 2 PIP (8X2 matrix) Mode

In the 2 PiP mode, one large window and 2 other smaller images, either on the side (side) or on the lower area of the screen (bottom) are displayed, while maintaining aspect ratio.

Perform the following actions:

Selecting the 2 PIP (8X2 matrix) layout settings tab

To select the 2 PIP (8X2 matrix) mode:

1. Click **Multi View** on the Navigation List. The Multi-View Settings page appears ([Figure 22](#)).
2. Select **8x2 matrix with 2 PIP** layout settings tab (see [Selecting a Windows Layout in the Multi-View Mode](#) on page [12](#)). The 8x2 matrix with 2 PIP layout tab appears ([Figure 33](#)).
3. Click **ACTIVATE MODE**. The page top bar displays the active matrix with selected multi-view layout mode. You are now ready to set your **2 PIP (8X2 matrix)** layout parameters.

Initial page of multi-view mode with **8x2 matrix with 2 PIP** layout settings appears, with matrix routing available active 1 and 5 outputs ([Figure 33](#)).



Layout windows grid appears only after input selection.

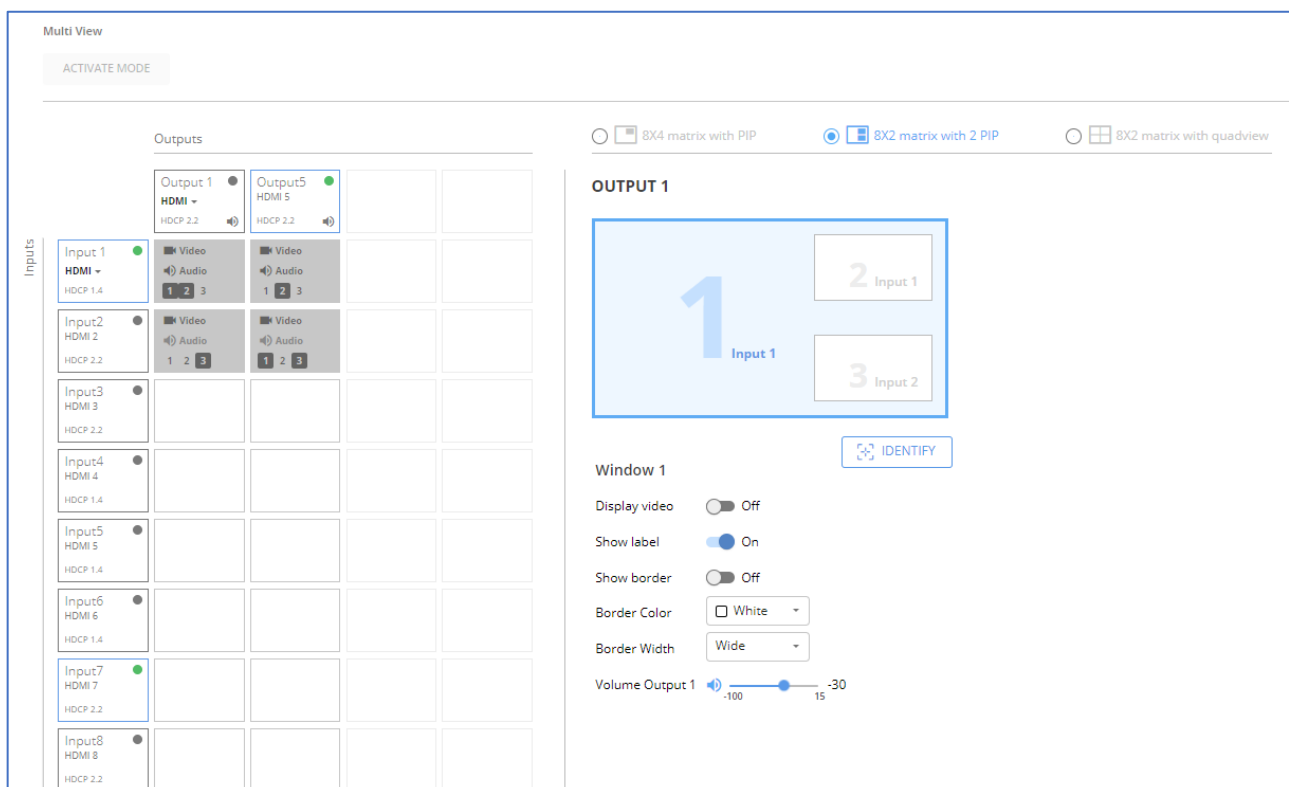

Figure 33: Multi View Mode – 8x2 Matrix with 2 PIP Layout – Initial Settings Page



Window 1 always represents the background image.

Setting inputs for the 2 PIP (8X2 matrix) view layout windows

1. Select any matrix routing input cross-point box, either for output 1 or 5.
 - Quad-view windows grid appears on the right side pane.
 - Selected output number appears above the windows grid.
 - Selected input cross-point box appears with 3 windows numbers (1, 2 or 3) to choose the window that this input relates to.
2. For each selected input cross-point box (input 1 to 8), select the input-related window (window 1, 2 or 3).
 - Selected window, in selected output quad-view grid, is blue-border highlighted, with related input number in its bottom right corner.
 - Click the cross-point box and verify that the Input number you select within the box (1, 2 or 3), is the output you wish to display in the window.
3. Repeat for the remaining active output and the remaining windows.

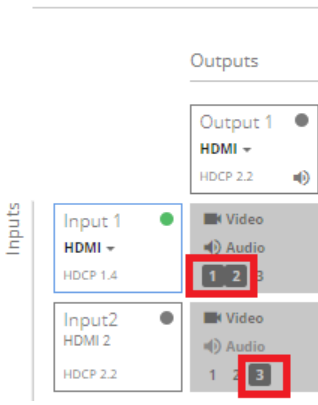
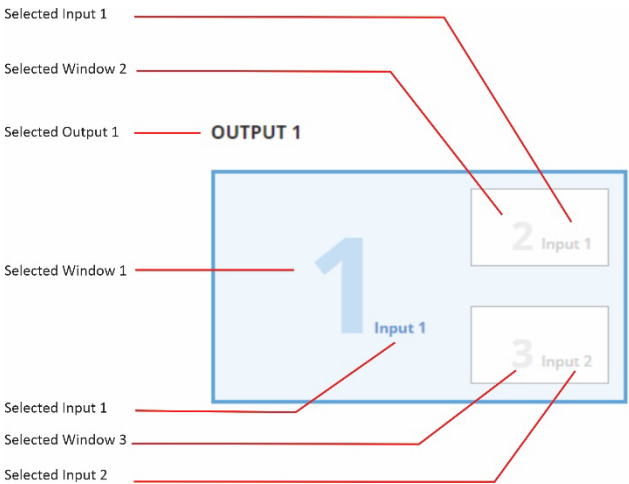
Matrix Routing Input -Output Cross-Point Box	Inputs	Outputs	Quad View Windows Grid
	1 and 2	1	 <p>To define quad-view layouts for Window 1, see Defining Quad-view layout windows on page 32.</p>

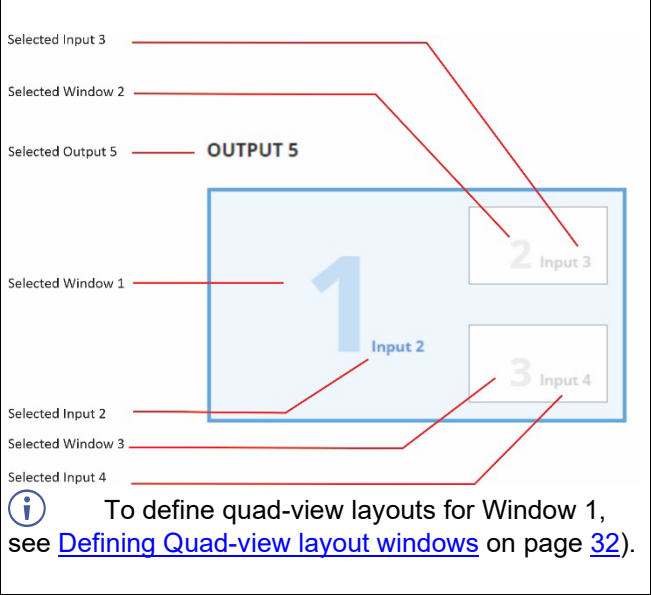
Matrix Routing Input -Output Cross-Point Box	Inputs	Outputs	Quad View Windows Grid
	2,3 and 4	5	 <p>Selected Input 3</p> <p>Selected Window 2</p> <p>Selected Output 5 OUTPUT 5</p> <p>Selected Window 1</p> <p>Selected Input 2</p> <p>Selected Window 3</p> <p>Selected Input 4</p> <p>i To define quad-view layouts for Window 1, see Defining Quad-view layout windows on page 32).</p>

- 4. Adjust the audio volume, for each output, using the Volume Output 1, 2 slider, in the grid-pane bottom right-hand side, or manually adjusting the volume level at the slider right side.

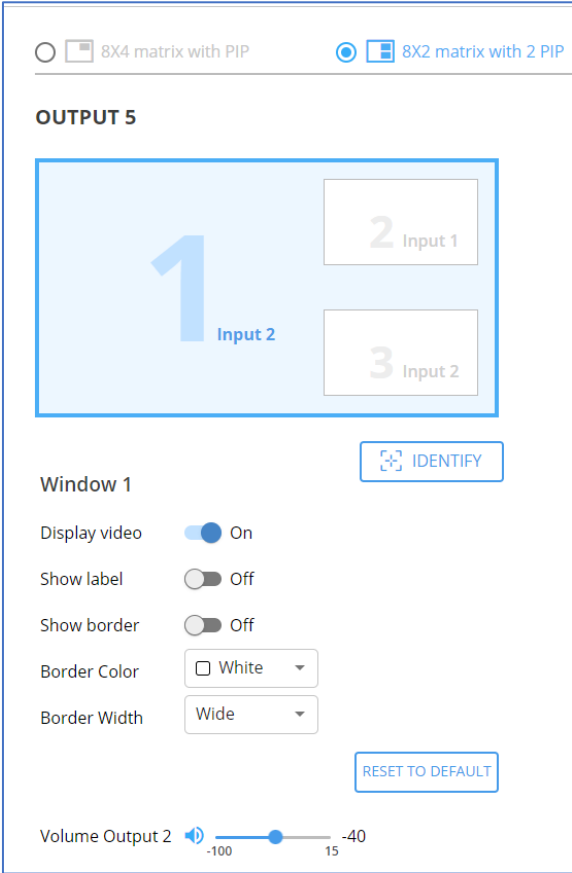

Figure 34: Multi View 8x2 Matrix with 2 PIP Layout – Adjusting Output Audio Volume

Defining 2 PIP (8X2 matrix) layout windows

You can set the parameters for each window separately.

To define a Window:

1. In the right-hand pane, click the desired window (1, 2 or 3).
 - The selected window is shaded blue.
 - The text **Window X** (1, 2 or 3) appears beneath the 2 PIP layout.
 - All parameters for that window are ready for parameter settings.
 - Set on/off for display video, show label and border parameters.
 - Select border color and width.

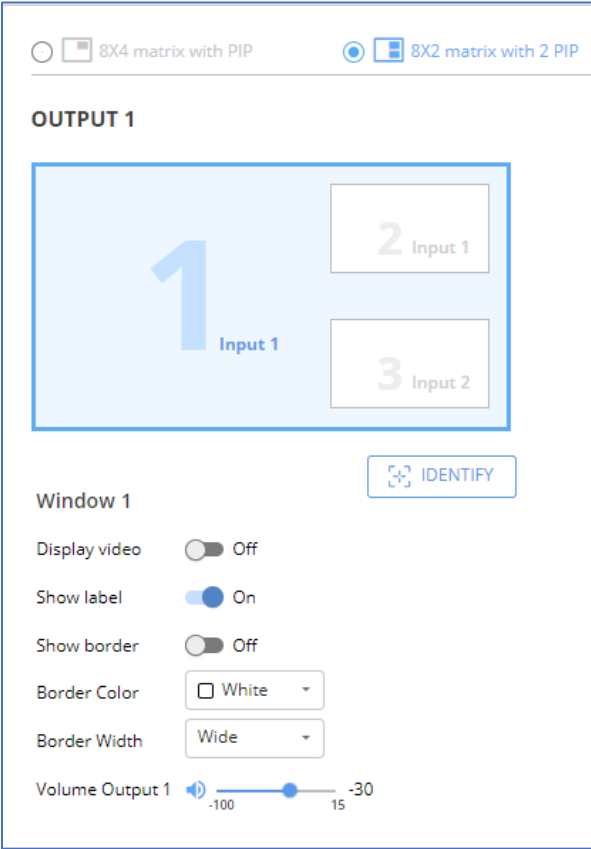

Figure 35: 2 PIP (8X2 Matrix) Layout – Window 1 Parameters Settings

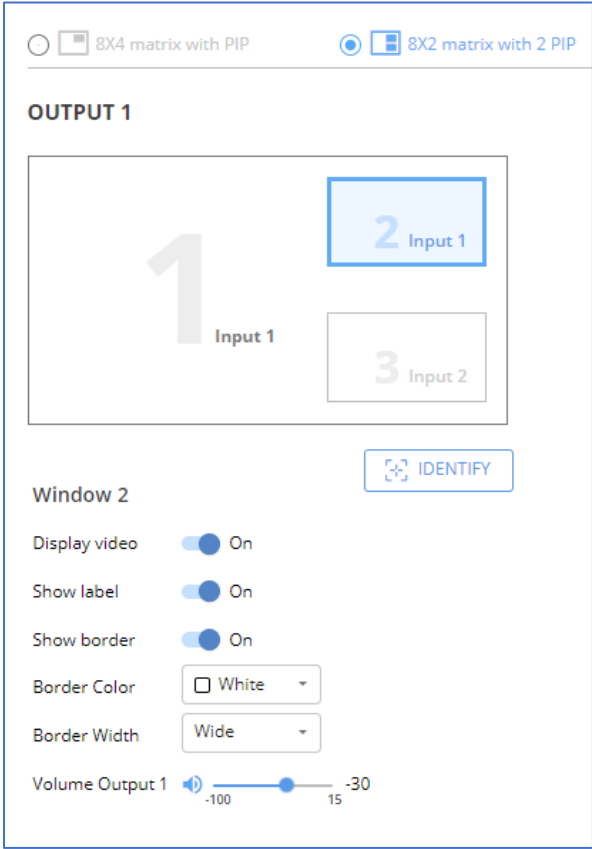

Figure 36: 2 PIP (8X2 Matrix) Layout – – Window 2 Parameters Settings



Figure 37: 2 PIP (8X2 Matrix) Layout – – Window 3 Parameters Settings

2. Click **IDENTIFY** to display each quad-view layout window number on output display via OSD for about 10 seconds.
3. Click **RESET TO DEFAULT** to reset settings to factory defaults.

Layout windows settings are defined.

Data Routing

Data Routing enables you to select the USB, RS-232 and IR signals for end-to-end extension between input HDBT to output HDBT. End-to-end USB 2.0 signal extension allows sharing remote USB devices between USB hosts connected to both HDBT-paired end-points. For more details on RS-232 and IR signals extension, [Configuring IR and RS-232 over HDBT](#) on page [14](#).

To manage data routing:

1. Click **Data Routing** on the Navigation List. The Data Routing page appears.

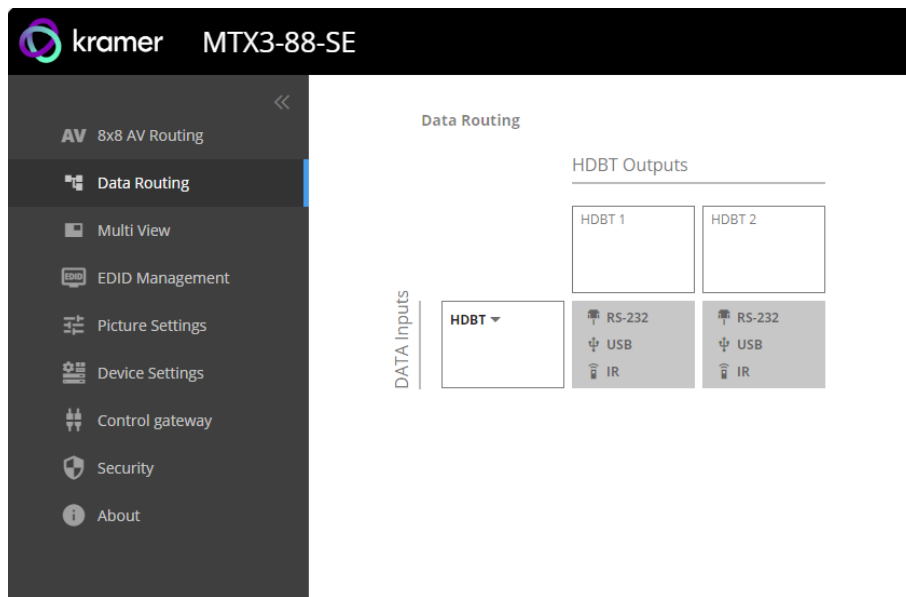

Figure 38: Data Routing Page

2. In the DATA Inputs drop down list: Select between HDBT or HDMI.



Routable signals (RS-232, USB & IR) are available depending on which input (HDBT or HDMI) is selected: For an HDMI input, the panel data ports (RS-232, IR) are shown; for an HDBT input, RS-232, USB and IR are shown.

3. In the HDBT Output HDBT 1 or HDBT 2 signals list, select the relevant routing required, such as HDBT to HDBT, USB to USB, or RS-232 to RS-232 extension. For more details on RS-232 and IR extension options, see [Configuring IR and RS-232 over HDBT](#) on page [14](#).

Managing EDID

MTX3-88-SE enables you to individually configure and manage EDID settings for each of the 4 inputs.

To manage EDID:

1. Click **EDID Management** on the Navigation List. The EDID Management page appears.

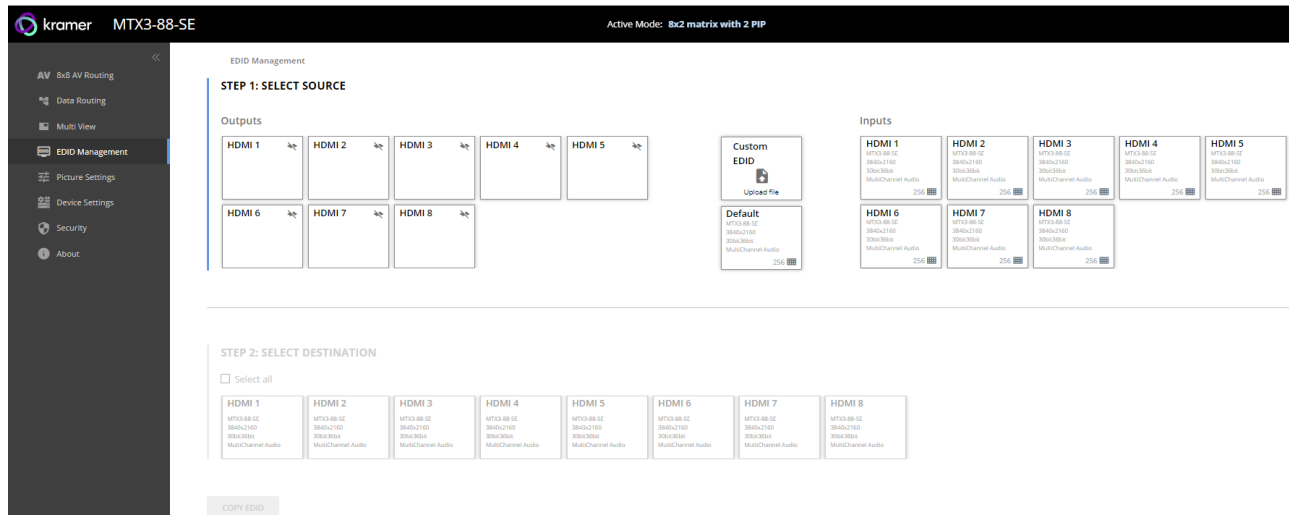

Figure 39: EDID Management Page

2. Under **STEP 1: SELECT SOURCE**, click the required EDID source from the outputs, inputs, default EDID or an uploaded EDID configuration file (for example, the default EDID file).

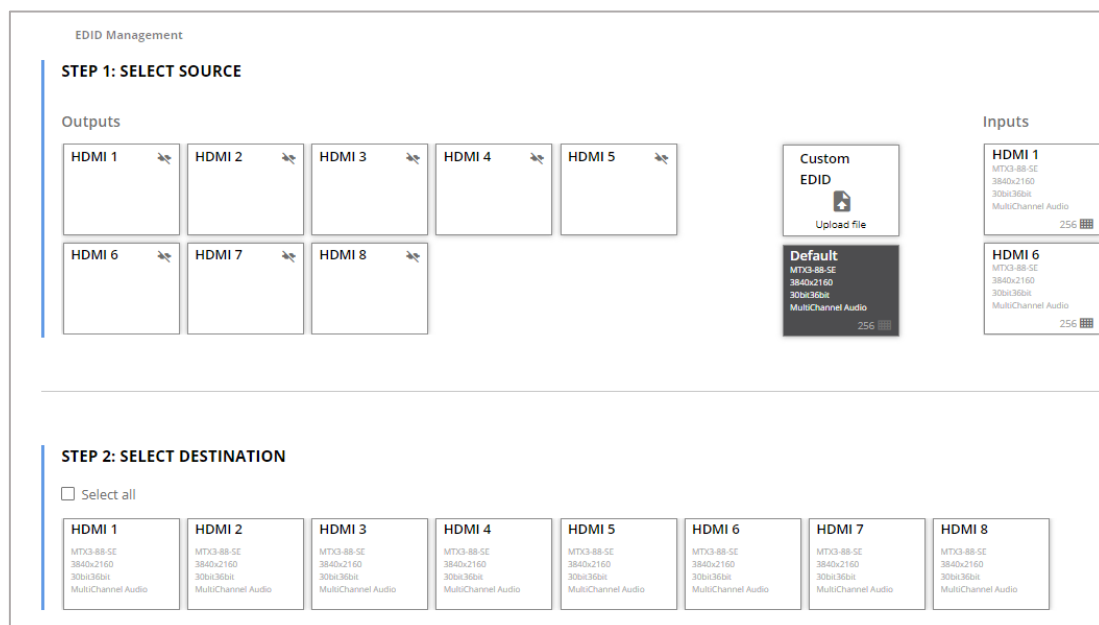

Figure 40: Selecting the EDID Source

- 3. Under **STEP 2: SELECT DESTINATIONS**, click the input/s to copy the selected EDID to.
The **COPY EDID** button is enabled.

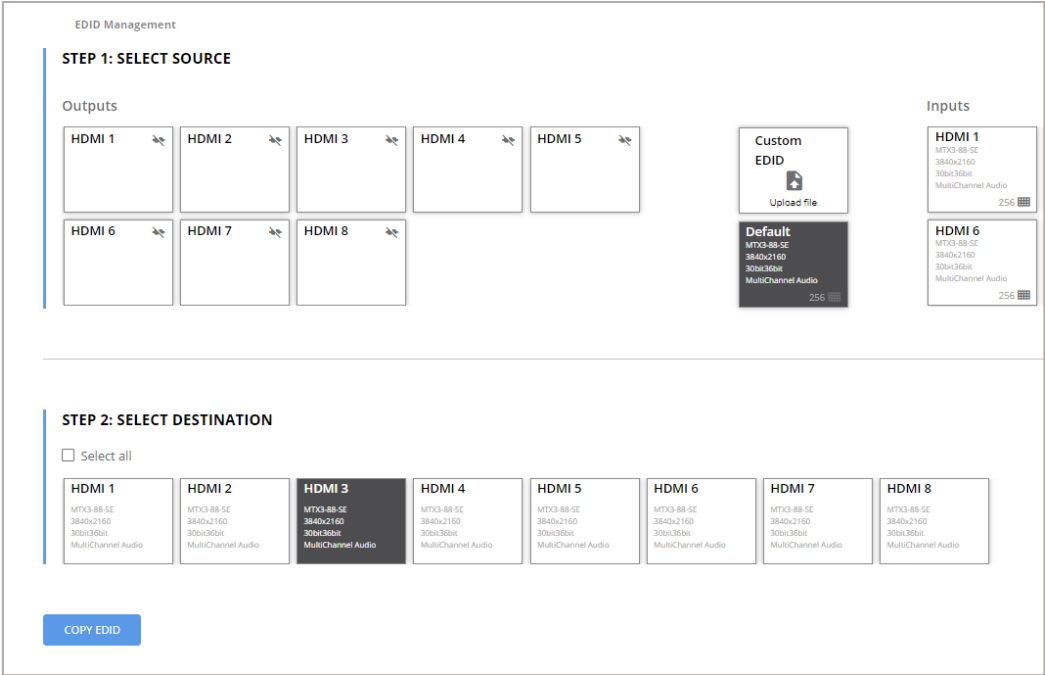

Figure 41: Selecting EDID Input Destinations

- 4. Click **COPY EDID**. The following message appears.

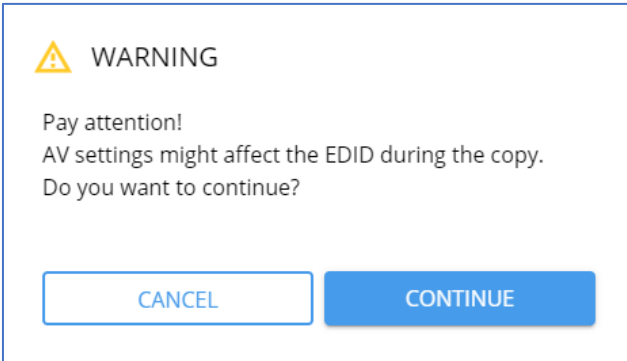

Figure 42: EDID Warning

- 5. Click **CONTINUE**. After EDID is copied, a success message appears.
EDID is copied to the selected input/s.

Picture Settings

Adjusting Input Parameters

For each operation mode you can adjust the input settings. Not all parameters are available for each operation mode.

To adjust input parameters:

1. Click **Picture Settings** on the Navigation List. The Picture Settings>Inputs page appears.
2. Click **Inputs** tab.

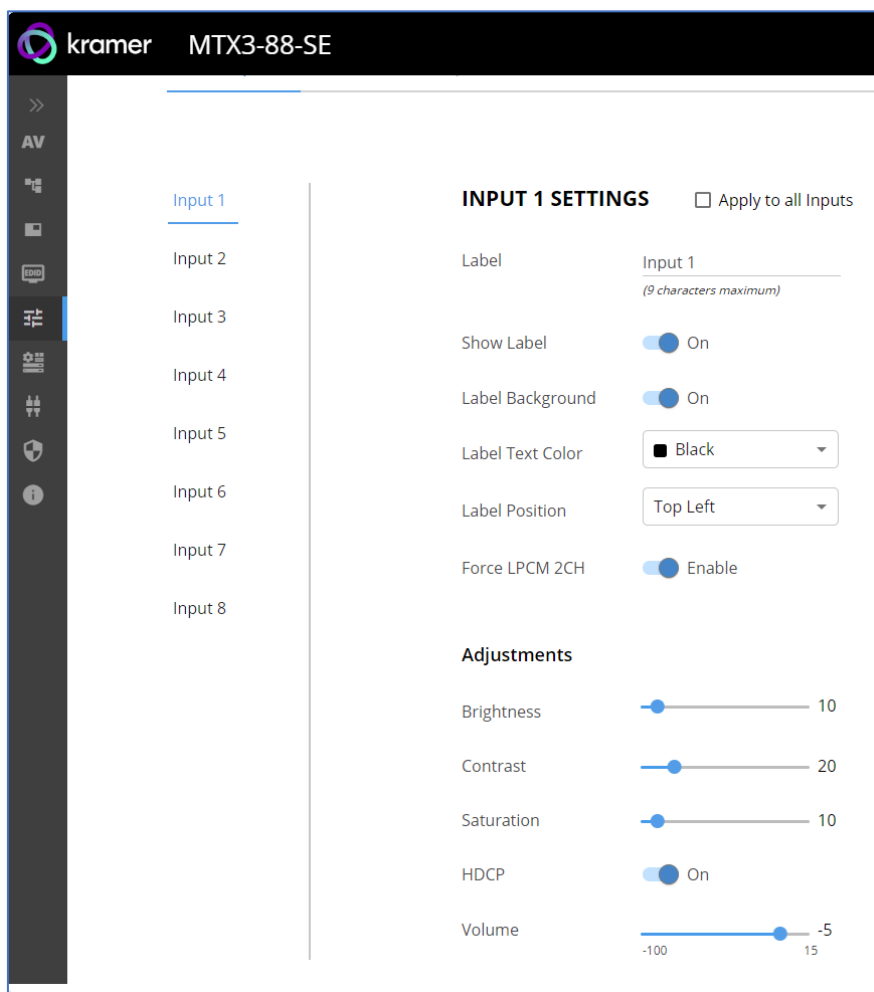

Figure 43: Picture Settings – Inputs Tab

3. For each input define the label:
 - Change the input name.
 - Hide/show the label.
 - Hide/show the label background.
 - Set the label text color.
 - Select label position on the display.

4. Use the sliders, text box or arrows next to the sliders for each input to adjust the:

- Brightness
- Contrast
- Saturation
- HDCP (select On/Off)
- Volume



If you need to make identical adjustments for all the inputs, check **Apply to all inputs** and adjust the video parameters on that input only. These parameters then apply to the other inputs.

Inputs are adjusted.

Adjusting Output Parameters

For each operation mode you can adjust the output settings. Not all parameters are available for each operation mode.

To adjust output parameters:

1. Click **Picture Settings** on the Navigation List. The Picture Settings>Inputs page appears.
2. Click **Outputs** tab.

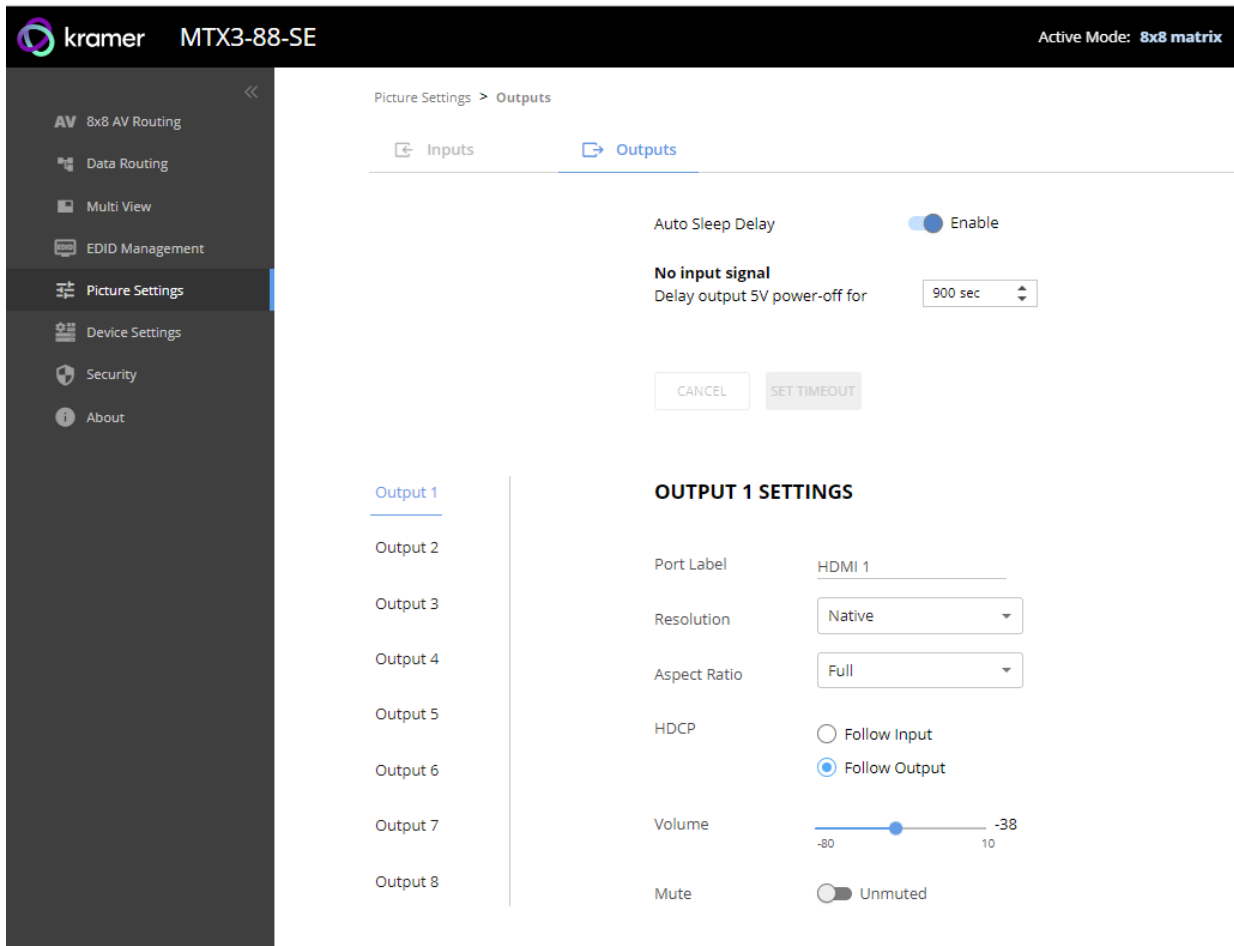

Figure 44: Picture Settings – Outputs Tab

3. For all outputs, you can define the time of sleep delay before the device powers-off automatically:

- Enable **Auto Sleep Delay**, set the **No input signal** (in seconds) and click **SET TIMEOUT**.



To save any changes, click **SET TIMEOUT**.

4. For each output:

- Change the name label.
- Select the output resolution.

- Select the Aspect Ratio.
- Set HDCP to Follow Input or Follow Output.
- Adjust the audio output volume.



Available for Output 1 and 2 only.

- Select Mute/Unmute.

Outputs are adjusted.

Setting Device Properties

MTX3-88-SE enables performing the following actions via the General Settings tab:

- [Device Profile and Maintenance](#) on page [49](#).
- [Settings Networking Properties](#) on page [51](#).

Device Profile and Maintenance

Changing Device Name

MTX3-88-SE enables you to change the DNS name of the device.

To change the device name:

1. In the Navigation list, click **Device Settings**. The *Device Settings>General* page appears.

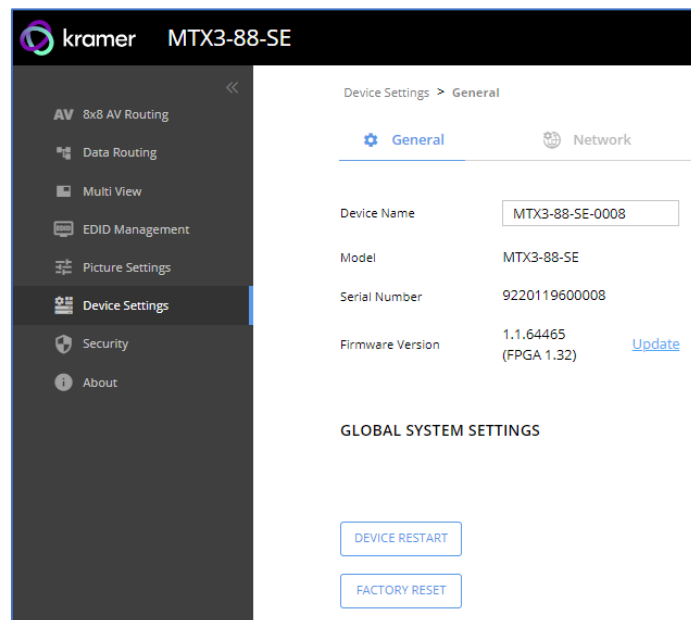

Figure 45: MTX3-88-SE Device Settings – General

2. Next to Device Name, enter the new device name (Max. 14 characters).
3. Click **SAVE**.

The device name is changed.

Upgrading Firmware

To update firmware:

1. In the Navigation list, click **Device Settings**. The *Device Settings>General* page appears ([Figure 45](#)).
2. Under General, click **Update**, open the relevant firmware file, and follow the instructions. The upgrade takes approximately 30-60 seconds.



- During FW upgrade, the device continues to operate, but the device UI and protocol 3000 communication are inactive. When device restarts, the status LED is lit, and HDMI output signal is disconnected until restart completes.

Firmware is updated.

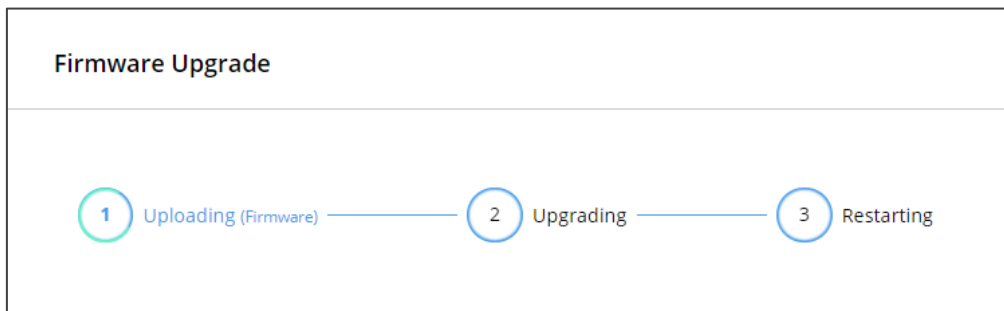

Figure 46:Firmware Upgrade Process

Restarting and Resetting the Device

Two types of resets can be performed:

- Restart – Reboots your device and keeps all your device settings, including the IP address and password.
- Reset – Reboots your device and restores all factory settings including input/output definitions, switching configuration, IP address and password (a DHCP-acquired IP address is retained).

To restart the device:

1. Click **DEVICE RESTART** on the **Device > General** page ([Figure 45](#)).
2. Click **CONTINUE**.

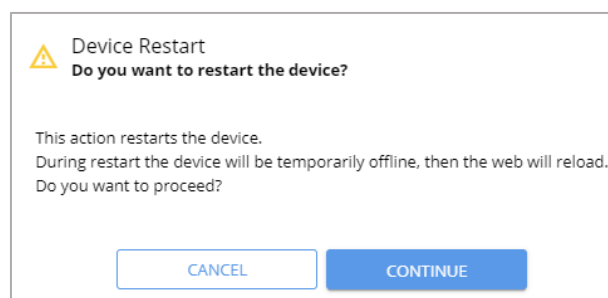

Figure 47: Restart the Device

The device restarts.

To perform a factory reset on the device, use one of the following actions:

- Click **FACTORY RESET** on the **Device > General** page ([Figure 45](#)).
- Using protocol 3000 commands, send **FACTORY** command then **RESET** commands.

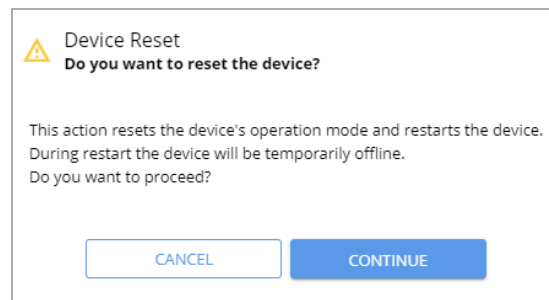

Figure 48: Reset the Device

3. Click **CONTINUE**.

The device resets.

Settings Networking Properties



By default, DHCP is set to on. The IP address shows the actual IP address acquired from the DHCP server, or the auto-acquired fallback IP address when there is no DHCP server detection.

To define network settings:

1. In the Navigation list, click **Device Settings**. The *Device Settings>General* page appears ([Figure 45](#)).
2. Select the **Network** tab. The Network tab appears.

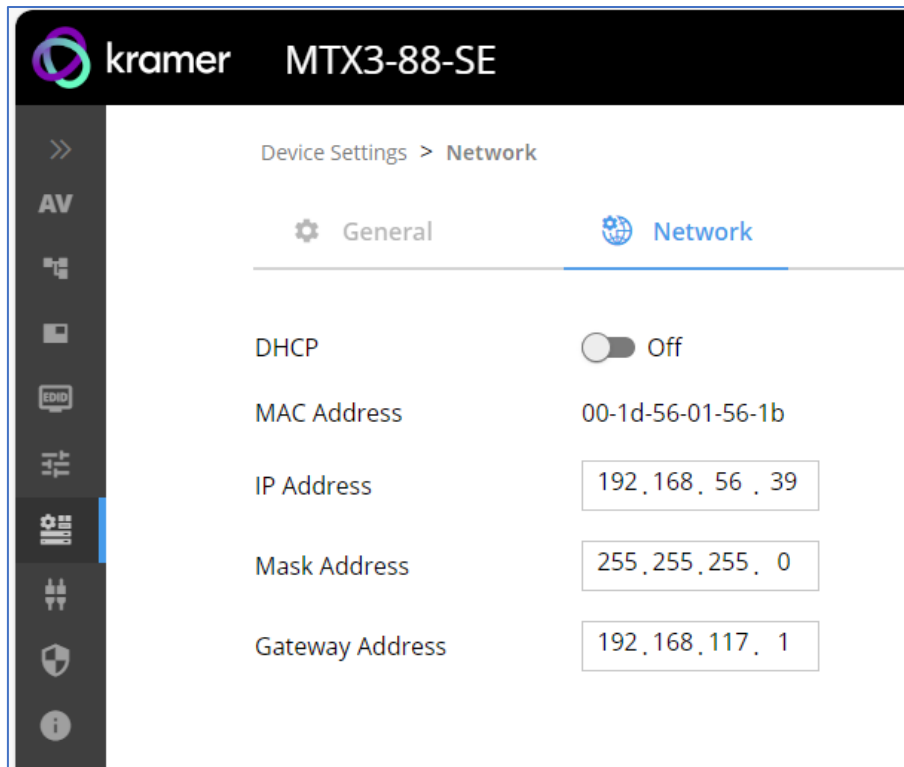

Figure 49: Device Settings – Network Tab

3. Set the Media port Stream service parameters:
 - **DHCP mode** – Set DHCP to **On** (default) or **Off**.
 - **IP Address** – When DHCP mode is set to Off, the device uses a static IP address. This requires entering mask and gateway addresses.
 - **Mask Address** – Enter subnet mask.
 - **Gateway address** – Enter the gateway address.
4. Define TCP (default, 5000) and UDP (default, 50000) ports.

Network settings are defined.

Setting Control Gateway Properties

Controlling an External Device

Control an external device via an IP-connected Controller (for example **SL-240C** that is connected via LAN)

To set the RS-232 port to control an external device:

1. Go to the Control Gateway page. The Serial Ports tab appears.
2. Next to Gateway, select **Advanced Properties**.

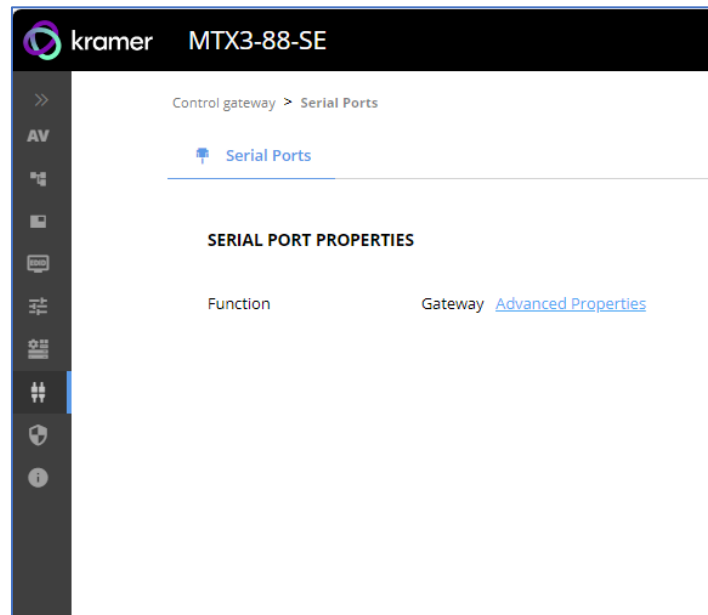

Figure 50: RS-232 as Gateway

The TUNNELING ADVANCED PROPERTIES Settings tab appears.

3. Select either UDP or TCP port.
4. Select IP Port.
5. Select (in seconds) TCP Keep alive.
6. Click to toggle ON Send replied to new client by default Bits.

7. Click **Close**.
8. Click **Save**.

Figure 51: Tunneling Advanced Properties Tab

RS-232 port controls an external device.

Setting Security Status

The Security tab enables activating device security and defining logon authentication details. When device security is on, web page access requires authentication upon initial landing on operation page. The default password is **Admin**. By default, security is disabled.

This section details the following actions:

- [Changing Security Status](#) on page [54](#).
- [Defining 802.1X Authentication](#) on page [57](#).

Changing Security Status

This section details the following:

- [Enabling User Access](#) on page [55](#).
- [Disabling User Access](#) on page [56](#).
- [Changing the Password](#) on page [56](#).

Enabling User Access

To enable security:

1. In the Navigation list, click **Security**.
2. Select Security tab.

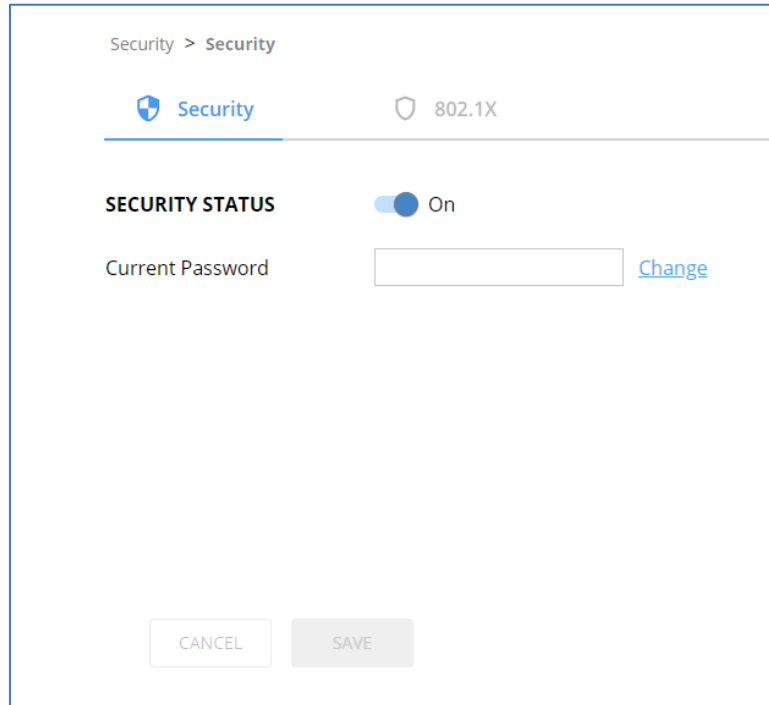

Figure 52: Device Settings – Security Tab

3. Click **On** next to Security Status to enable web page authentication (Off by default).

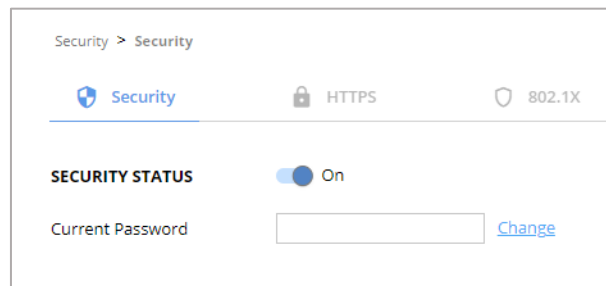

Figure 53: Security Tab – Security On

4. Click **CHANGE**.
5. Enter the new password and then confirm password.
6. Click **SAVE**.

Security is enabled and access requires authentication.

Disabling User Access

To enable security:

1. In the Navigation list, click **Security**.
2. Select Security tab.
3. Click **Off** next to Security Status to enable web page authentication. The following message appears.

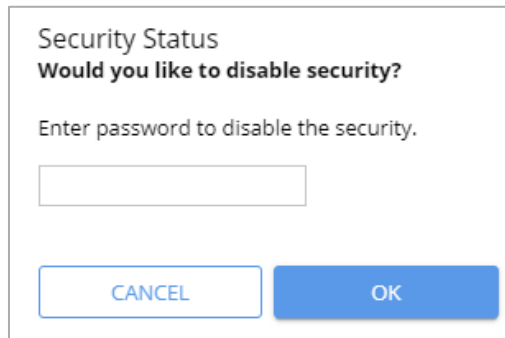
A dialog box titled "Security Status" with the question "Would you like to disable security?". Below the question is the instruction "Enter password to disable the security." followed by a text input field. At the bottom of the dialog are two buttons: "CANCEL" and "OK".

Security Status
Would you like to disable security?
Enter password to disable the security.

CANCEL OK

Figure 54: Security Tab – Security Status

4. Enter the current password.
5. Click **OK**.

Security is disabled.

Changing the Password

To change the password:

1. In the Navigation list, click **Security**.
2. Select Security tab.
3. Next to Current Password, enter the current password.
4. Click **CHANGE**.
5. Next to New Password, enter the new password.
6. Next to Confirm Password, enter the new password again.
7. Click **SAVE**.

Password has changed.

Defining 802.1X Authentication

802.1X security standard supports IT networking authentication based on LAN port and MAC address.

To configure security:

- 1. In the Navigation pane, click **Security**. The Security settings tab in the Security page appears.
- 2. Select **802.1X** tab. The 802.1X settings tab appears.

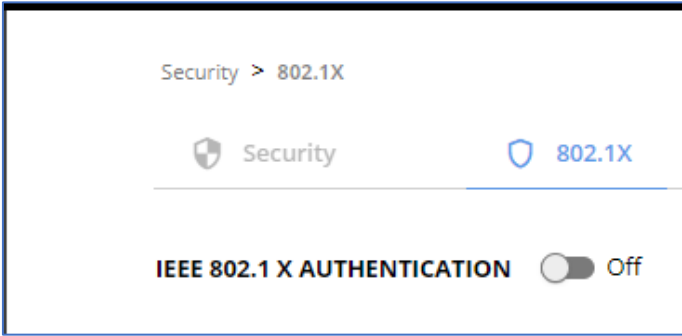

Figure 55: 802.1X Tab

- 3. For 802.1x authentication, click **ON** to enable 802.1X authentication service. 802.1X supports authentication based on port and MAC address.
- 4. When set to ON check one standard authentication method to set its security attributes.
 - **EAP-MSCHAP V2** (Figure 56) – Enter:
 - Username - up to 24 alphanumeric characters, including “_” and “-“ characters within the username, and
 - Password - up to 24 ASCII characters

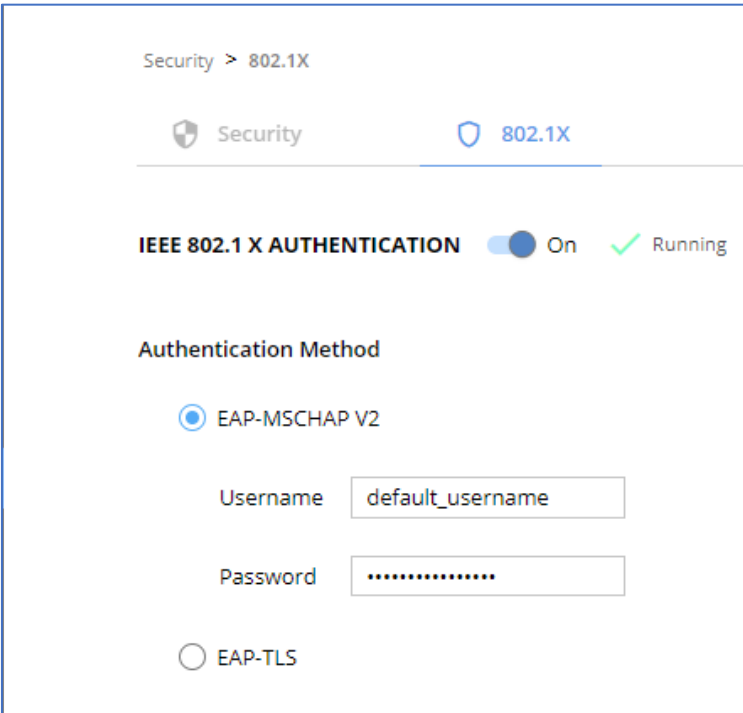

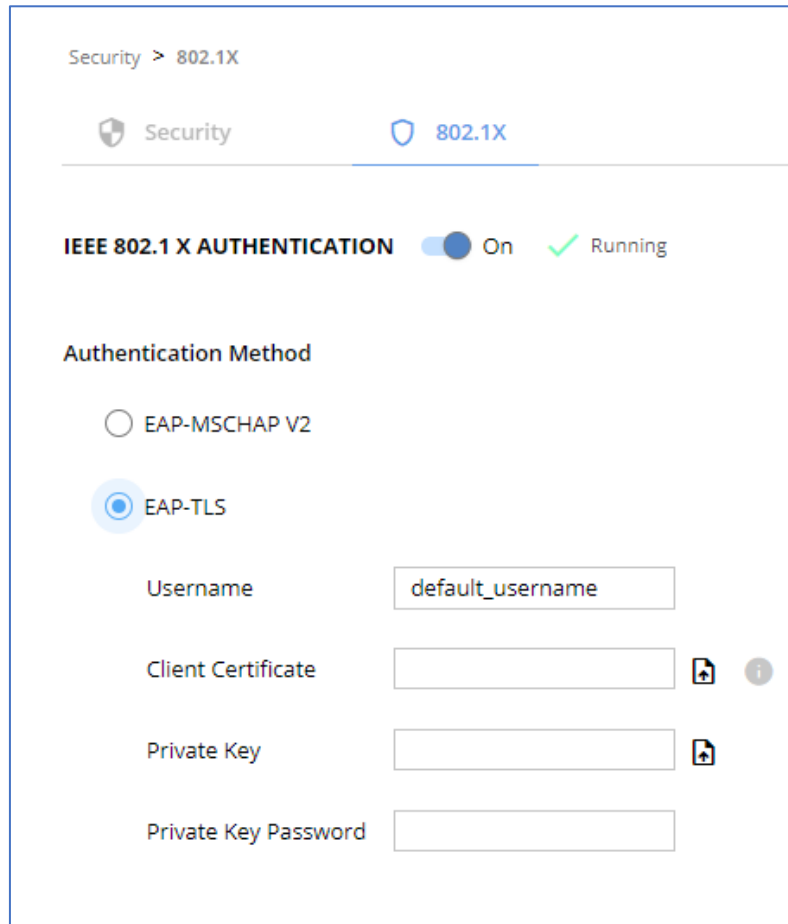



Figure 57: Security Tab – EAP-MSCHAP V2 Authentication

- **EAP-TLS** (Figure 58) – To submit certificate from the server for authentication:
 - Enter Username,
 - Click  to upload the certificates and keys,
 - Enter the private key password (assigned by IT administrator),
 - Set Server Certificate **On**



Security > 802.1X

Security 802.1X



IEEE 802.1 X AUTHENTICATION On  Running

Authentication Method

EAP-MSCHAP V2

EAP-TLS

Username

Client Certificate  

Private Key 

Private Key Password

Figure 59: Certificates and Password

5. Click **APPLY**.

802.1X authentication security is configured.

Viewing the About Page

View the firmware version and Kramer Electronics Ltd details in the About page.

To view the device status:

1. In the navigation pane, select **About**.
2. Select the **General Info** tab. The Devices Status appears.

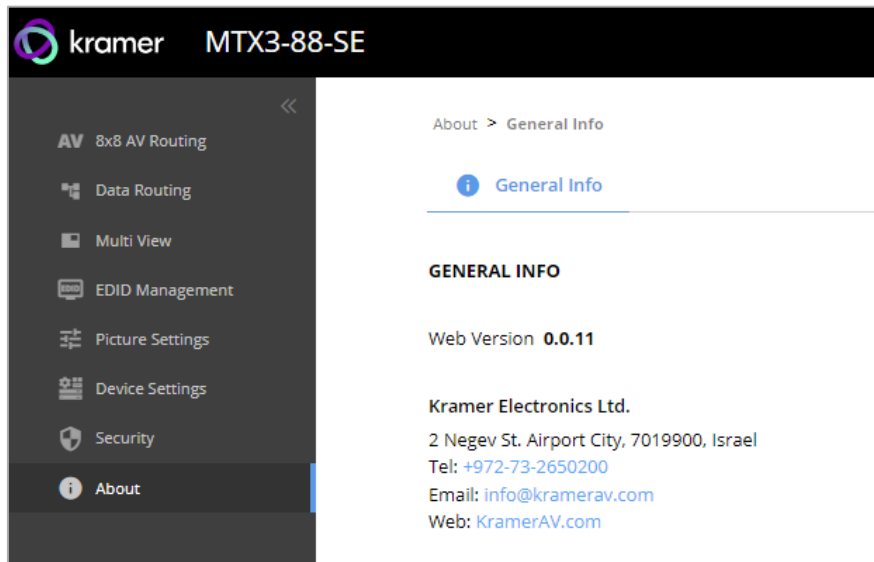

Figure 60: About Page

Upgrading the Firmware

Use the Kramer **K-UPLOAD** software to upgrade the firmware via ethernet. The device continues to operate and once FW upload complete, you are asked to Restart now or later.

The latest version of **K-UPLOAD** and installation instructions can be downloaded from our website at: www.kramerav.com/support/product_downloads.asp.

Setting the DIP-Switches

All changes in DIP-Switches apply immediately, on-the-fly (no need to power cycle the device).



All DIP-switches are set to OFF (up) by default.

DIP #	Feature	DIP-switch State	State Description
1, 2	RS-232 HDBT to-HDBT Extension	Off (default)	(see Configuring IR and RS-232 over HDBT on page 14).
		On	
3, 4	IR HDBT-to-HDBT Extension	Off (default)	
		On	
5, 6, 7, 8	For future use	Off (default)	Mandatory
		On	N/A

Technical Specifications

Inputs	1 HDBT 3.0	On an RJ-45 female connector
	8 HDMI	On female HDMI connectors
Outputs	2 HDBT 3.0	On RJ-45 female connectors
	9 HDMI	On female HDMI connectors
	4 Balanced Stereo Line Level	On 5-pin terminal block connectors
Ports	2 RS-232	On a 5-pin terminal block connector
	1 LAN	On an RJ-45 female connector
	2 RS-232 + IR (for HDBT outputs)	On 5-pin terminal block connectors, for serial and IR link extension
	1 RS-232 + IR (for HDBT outputs)	On a 5-pin terminal block connectors, for serial and IR link extension
Video	Max Bandwidth	18Gbps (6Gbps per graphic channel)
	Max Resolution	4K @60Hz (4:4:4) resolution
	Content Protection	HDCP 2.3
	Input & Output Resolutions	1024X768P/60, 1280X768P/60, 1280X720P/60, 1280X720P/50, 1280X720P/24, 1280X720P/25, 1280X720P/30, 1280X1024P/60, 1600X1200P/60, 1680X1050P/60, 1920X1080P/60, 1920X1080P/50, 1920X1080P/24, 1920X1080P/25, 1920X1080P/30, 1920X1200P/60, 3840X2160P/24, 3840X2160P/25, 3840X2160P/30, 3840X2160P/50, 3840X2160P/60
	Input Color-space	RGB; YUV 4:4:4
	HDMI Support	Deep Color, 3D, HDR as specified in HDMI 2.0b
Controls	Front Panel	Output and input selector buttons, system set up buttons, store and recall buttons, display identify button, reset button and panel lock button
Extension Line	Reach	Up to 100m (330ft), when using Kramer HDBaseT cables
	PoE Providing	15W per 802.3at Type 1
	Standards Compliance	HDBaseT 3.0
Extended USB	Max USB 2.0 Data Rate	480Mbps
	Max Transmitted Data Bandwidth	300Mbps
	Standards Compliance	USB 2.0 and 1
Extended Ethernet	Max Data Rate	100Mbps
Extended RS-232	Baud Rate	300 to 115200
Analog Audio	Max Level	9dBu
	Impedance	500Ω
	Bandwidth	20Hz - 20kHz
	Crosstalk	-114dB
	THD + N	0.005% @1kHz at nominal level
	S/N Ratio	-89dB, 20Hz - 20kHz
	Coupling	DC
Power	Consumption	100-240V AC, 98VA max.

	Heat Dissipation	55W (188BTU/hr)
Environmental Conditions	Operating Temperature	0° to +40°C (32° to 104°F)
	Storage Temperature	-40° to +70°C (-40° to 158°F)
	Humidity	10% to 90%, RHL non-condensing
Regulatory Compliance	Safety	CE, FCC, UKCA
	Environmental	RoHs, WEEE
Enclosure	Size	19" 2U
	Type	Aluminum
	Cooling	Fan Ventilation
General	Net Dimensions (W, D, H)	43.7cm x 23.6 cm x 8.8cm (17.2" x 9.3" x 3.5")
	Shipping Dimensions (W, D, H)	52.6cm x 47.5cm x 18.4cm (20.7" x 18.7" x 7.2")
	Net Weight	3.9kg (8.6lbs)
	Shipping Weight	5.4kg (12lbs) approx.
Accessories	Included	Power cord
Product Warranty Period	84 (Months)	
Specifications are subject to change without notice at www.kramerav.com		

Default Communication Parameters

RS-232	
Baud Rate:	115,200
Data Bits:	8
Stop Bits:	1
Parity:	None
Command Format:	ASCII
Example (Route video input 2 to the output):	#ROUTE_1,1,2<CR>
Ethernet	
To reset the IP settings to the factory reset values go to: Menu->Setup -> Factory Reset-> press Enter to confirm	
Fallback IP Address:	192.168.1.39
Fallback Subnet mask:	255.255.255.0
Fallback gateway:	192.168.0.1
Default username:	Admin
Default password:	Admin
Full Factory Reset	
P3K	Send FACTORY command then RESET
Embedded webpages	Go to: Device>General and click FACTORY RESET

Protocol 3000

Kramer devices can be operated using Kramer Protocol 3000 commands sent via serial or Ethernet ports.

Understanding Protocol 3000

Protocol 3000 commands are a sequence of ASCII letters, structured according to the following.

- **Command format:**

Prefix	Command Name	Constant (Space)	Parameter(s)	Suffix
#	Command	_	Parameter	<CR>

- **Feedback format:**

Prefix	Device ID	Constant	Command Name	Parameter(s)	Suffix
~	nn	@	Command	Parameter	<CR><LF>

- **Command parameters** – Multiple parameters must be separated by a comma (,). In addition, multiple parameters can be grouped as a single parameter using brackets ([and]).
- **Command chain separator character** – Multiple commands can be chained in the same string. Each command is delimited by a pipe character (|).
- **Parameters attributes** – Parameters may contain multiple attributes. Attributes are indicated with pointy brackets (<...>) and must be separated by a period (.).

The command framing varies according to how you interface with **MTX3-88-SE**. The following figure displays how the # command is framed using terminal communication software (such as Hercules):

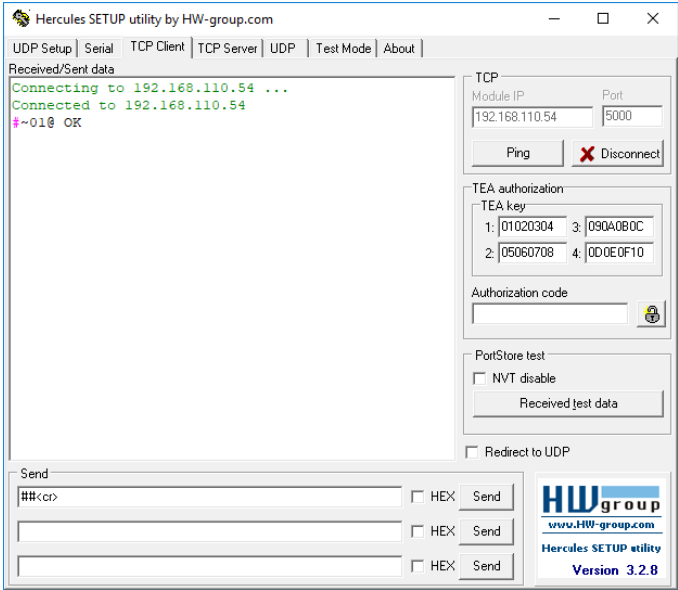

Protocol 3000 Commands

Function	Description	Syntax	Parameters/Attributes	Example
#	Protocol handshaking. ① Validates the Protocol 3000 connection and gets the machine number. Step-in master products use this command to identify the availability of a device.	COMMAND #<CR> FEEDBACK ~nn@_ok<CR><LF>		#<CR>
AUD-LVL	Set volume level.	COMMAND #AUD-LVL_ <u>io_mode</u> , <u>io_index</u> , <u>vol_db</u> <CR> FEEDBACK ~nn@AUD-LVL_ <u>io_mode</u> , <u>io_index</u> , <u>vol_level</u> <CR><LF>	<u>io_mode</u> – Input/Output 0 – Input 1 – Output <u>io_index</u> – Number that indicates the specific input or output port: 1-8 <u>vol_db</u> – Volume level -80db to 0dB; ++ (increase current value by 1dB); -- (decrease current value by 1dB)	Set OUT 2 AUDIO level to -50dB: #AUD-LVL_ <u>1</u> , <u>2</u> , <u>-50</u> <CR>
AUD-LVL?	Get volume level.	COMMAND #AUD-LVL?_ <u>io_mode</u> , <u>io_index</u> <CR> FEEDBACK ~nn@AUD-LVL_ <u>io_mode</u> , <u>io_index</u> , <u>vol_db</u> <CR><LF>	<u>io_mode</u> – Input/Output 0 – Input 1 – Output <u>io_index</u> – Number that indicates the specific input or output port: 1-8 <u>vol_db</u> – Volume level -80db to 0dB; ++ (increase current value by 1dB); -- (decrease current value by 1dB)	Get AUDIO OUT 1 level #AUD-LVL?_ <u>1</u> , <u>1</u> <CR>
AUD-LVL-RANGE?	Get audio level min and max range. ① In most devices min and max audio level is a function of HW implementation and the SET command is usually not implemented.	COMMAND #AUD-LVL-RANGE?_ <u>io_mode</u> , <u>io_index</u> <CR> FEEDBACK ~nn@AUD-LVL-RANGE_ <u>io_mode</u> , <u>io_index</u> , <u>min_vol</u> , <u>max_vol</u> <CR><LF>	<u>io_mode</u> – Input/Output 0 – Input 1 – Output <u>io_index</u> – Number that indicates the specific input or output port: 1-8 <u>min_vol</u> – Minimal available audio level <u>max_vol</u> – Maximum available audio level	Get audio level min and max range for output 2: #AUD-LVL-RANGE?_ <u>1</u> , <u>2</u> <CR>
AUD-MUTE	Set audio mute.	COMMAND #AUD-MUTE_ <u>out_index</u> , <u>mute_mode</u> <CR> FEEDBACK ~nn@AUD-MUTE_ <u>out_index</u> , <u>mute_mode</u> <CR><LF>	<u>out_index</u> – 1 <u>mute_mode</u> – On/Off 0 – Off 1 – On	Set Output 1 to mute: #AUD-MUTE_ <u>1</u> , <u>1</u> <CR>
AUD-MUTE?	Set audio mute.	COMMAND #AUD-MUTE_ <u>out_index</u> <CR> FEEDBACK ~nn@AUD-MUTE_ <u>out_index</u> , <u>mute_mode</u> <CR><LF>	<u>out_index</u> – 1 <u>mute_mode</u> – On/Off 0 – Off 1 – On	Get Output 1 to mute: #AUD-MUTE_ <u>1</u> , <u>1</u> <CR>
AV-SW-TIMEOUT	Set auto switching timeout.	COMMAND #AV-SW-TIMEOUT_ <u>switching_mode</u> , <u>time_out</u> <CR> FEEDBACK ~nn@AV-SW-TIMEOUT_ <u>switching_mode</u> , <u>time_out</u> <CR><LF>	<u>switching_mode</u> – Switching mode 4 – Disable 5V on video output if no input signal detected <u>time_out</u> – Timeout in seconds 0 - 60000	Set the auto switching timeout to 5 seconds in the event of 5V disable when no input signal is detected: #AV-SW-TIMEOUT_ <u>4</u> , <u>5</u> <CR>
AV-SW-TIMEOUT?	Set auto switching timeout.	COMMAND #AV-SW-TIMEOUT?_ <u>switching_mode</u> <CR> FEEDBACK ~nn@AV-SW-TIMEOUT_ <u>switching_mode</u> , <u>time_out</u> <CR><LF>	<u>switching_mode</u> – Switching mode 4 – Disable 5V on video output if no input signal detected <u>time_out</u> – Timeout in seconds 0 - 60000	Get the auto switching timeout in the event of 5V disable when no input signal is detected: #AV-SW-TIMEOUT?_ <u>4</u> <CR>
BEACON-INFO?	Get beacon information, including IP address, UDP control port, TCP control port, MAC address, model, name. ① There is no Set command. Get command initiates a notification.	COMMAND #BEACON-INFO?_ <u>port_id</u> <CR> FEEDBACK ~nn@BEACON-INFO_ <u>port_id</u> , <u>ip_string</u> , <u>udp_port</u> , <u>tcp_port</u> , <u>mac_address</u> , <u>model</u> , <u>name</u> <CR><LF>	<u>port_id</u> – 0 <u>ip_string</u> – Dot-separated representation of the IP address <u>udp_port</u> – UDP control port <u>tcp_port</u> – TCP control port <u>mac_address</u> – Dash-separated mac address <u>model</u> – Device model <u>name</u> – Device name	Get beacon information: #BEACON-INFO?_ <u>0</u> <CR>

Function	Description	Syntax	Parameters/Attributes	Example
BRIGHTNESS	<p>Set image brightness per output.</p> <p>i Value limits can vary for different devices.</p> <p>Value is a property of input connected to current output. Changing input source might cause changes in this value (refer device definitions).</p> <p>In devices that enable showing multiple outputs on one display – each in a separate window – this command relates only to the window associated with the output indicated in the out-index parameter.</p>	<p>COMMAND</p> <pre>#BRIGHTNESS_<out_index>,value<CR></pre> <p>FEEDBACK</p> <pre>~nn@BRIGHTNESS_<out_index>,value<CR><LF></pre>	<p>out_index – Number that indicates the specific output: 1-9</p> <p>value – Brightness value (0-100)</p>	<p>Set brightness for output 1 to 50:</p> <pre>#BRIGHTNESS_1,50<CR></pre>
BRIGHTNESS?	<p>Get image brightness per output.</p> <p>i Value limits can vary for different devices.</p> <p>Value is a property of input connected to current output. Changing input source might cause changes in this value (refer device definitions).</p> <p>In devices that enable showing multiple outputs on one display – each in a separate window – this command relates only to the window associated with the output indicated in the out-index parameter.</p>	<p>COMMAND</p> <pre>#BRIGHTNESS?_<out_index><CR></pre> <p>FEEDBACK</p> <pre>~nn@BRIGHTNESS_<out_index>,value<CR><LF></pre>	<p>out_index – Number that indicates the specific output: 1-9</p> <p>value – Brightness value (0-100)</p>	<p>Get brightness for output 1:</p> <pre>#BRIGHTNESS?_1<CR></pre>
BUILD-DATE?	<p>Get device build date.</p>	<p>COMMAND</p> <pre>#BUILD-DATE?_<CR></pre> <p>FEEDBACK</p> <pre>~nn@BUILD-DATE_<date>,time<CR><LF></pre>	<p>date – Format: YYYY/MM/DD where YYYY = Year MM = Month DD = Day</p> <p>time – Format: hh:mm:ss where hh = hours mm = minutes ss = seconds</p>	<p>Get the device build date:</p> <pre>#BUILD-DATE?<CR></pre>
CONF-EXPORT	<p>Export configuration file.</p>	<p>COMMAND</p> <pre>#CONF-EXPORT_<CR></pre> <p>FEEDBACK</p> <pre>~nn@CONF-EXPORT_<system>/export/mtx3-88-SE_Configuration.bin<CR><LF></pre>		<p>Export configuration file:</p> <pre>#CONF-EXPORT_<CR></pre>
CONF-IMPORT	<p>Import configuration file.</p>	<p>COMMAND</p> <pre>#CONF-IMPORT_<CR></pre> <p>FEEDBACK</p> <pre>~nn@CONF-IMPORT_<system>/import/MTX2_Configuration.bin<CR><LF></pre>		<p>Import configuration file:</p> <pre>#CONF-IMPORT_<CR></pre>

Function	Description	Syntax	Parameters/Attributes	Example
CONTRAST	<p>Set image contrast per output.</p> <p>ⓘ Value limits can vary for different devices.</p> <p>Value is a property of input connected to current output. Changing the input source might cause changes in this value (refer to device definitions).</p> <p>In devices that enable showing multiple outputs on one display – each in a separate window – this command relates only to the window associated with the output indicated in the out_index parameter.</p>	<p>COMMAND #CONTRAST_<u>out_index</u>,value<CR></p> <p>FEEDBACK ~nn@CONTRAST_<u>out_index</u>,value<CR><LF></p>	<p>out_index – Number that indicates the specific output: 1-8</p> <p>value – Contrast value (1-100)</p>	<p>Set contrast for output 1 to 40: #CONTRAST_<u>1</u>,40<CR></p>
CONTRAST?	<p>Get image contrast per output.</p> <p>ⓘ Value limits can vary for different devices.</p> <p>Value is a property of input connected to current window. Changing the window input source might cause changes in this value (refer to device definitions).</p> <p>In devices that enable showing multiple outputs on one display – each in a separate window – this command relates only to the window associated with the output indicated in the out_index parameter.</p>	<p>COMMAND #CONTRAST?<u>out_index</u><CR></p> <p>FEEDBACK ~nn@CONTRAST_<u>out_index</u>,value<CR><LF></p>	<p>out_index – Number that indicates the specific output: 1-8</p> <p>value – Contrast value (1-100)</p>	<p>Get contrast for output 1: #CONTRAST?<u>1</u><CR></p>
CPEDID	<p>Copy EDID data from the output to the input EEPROM.</p> <p>ⓘ Destination bitmap size depends on device properties (for 64 inputs it is a 64-bit word).</p> <p>Example: bitmap 0x0013 means inputs 1,2 and 5 are loaded with the new EDID.</p> <p>In certain products Safe_mode is an optional parameter. See the HELP command for its availability.</p>	<p>COMMAND #CPEDID_<u>edid_io</u>,<u>src_id</u>,<u>edid_io</u>,<u>dest_bitmap</u><CR></p> <p>or #CPEDID_<u>edid_io</u>,<u>src_id</u>,<u>edid_io</u>,<u>dest_bitmap</u>,<u>safe_mode</u><CR></p> <p>FEEDBACK ~nn@CPEDID_<u>edid_io</u>,<u>src_id</u>,<u>edid_io</u>,<u>dest_bitmap</u><CR><LF></p> <p>~nn@CPEDID_<u>edid_io</u>,<u>src_id</u>,<u>edid_io</u>,<u>dest_bitmap</u>,<u>safe_mode</u><CR><LF></p>	<p>edid_io – EDID source type (usually output) 0 – Input 1 – Output 2 – Default EDID 3 – Custom EDID</p> <p>src_id – Number of chosen source stage 0 – Default EDID source 1 – Output 1 2 – Output 2 3 – Output 3 4 – Output 4 5 – Output 5 6 – Output 6 7 – Output 7 8 – Output 8</p> <p>edid_io – EDID destination type (usually input) 0 – Input 1 – Output 2 – Default EDID 3 – Custom EDID</p> <p>dest_bitmap – Bitmap representing destination IDs. Format: XXXX...X, where X is hex digit. The binary form of every hex digit represents corresponding destinations. 0 – indicates that EDID data is not copied to this destination. 1 – indicates that EDID data is copied to this destination.</p> <p>safe_mode – Safe mode 0 – device accepts the EDID as is without trying to adjust 1 – device tries to adjust the EDID (default value if no parameter is sent)</p>	<p>Copy the EDID data from the Output 1 (EDID source) to the Input: #CPEDID_<u>1</u>,1,0,0x1<CR></p> <p>Copy the EDID data from the default EDID source to the Input: #CPEDID_<u>2</u>,0,0,0x1<CR></p>

Function	Description	Syntax	Parameters/Attributes	Example
DISPLAY?	Get output HPD status.	COMMAND #DISPLAY?_out_index<CR> FEEDBACK ~nn@DISPLAY_out_index,status<CR><LF>	out_index – Number that indicates the specific output: 1-9 status – HPD status according to signal validation 0 – Signal or sink is not valid 1 – Signal or sink is valid 2 – Sink and EDID is valid	Get the output HPD status of Output 1: #DISPLAY?_1<CR>
EDID-AUDIO	Set audio capabilities for EDID.	COMMAND #EDID-AUDIO_io_index,audio_format<CR> FEEDBACK ~nn@EDID-AUDIO_io_index,audio_format<CR><LF>	io_index – Number that indicates the specific input port: 1-4 audio_format – Audio block added to EDID: 0 – Auto 1 – LPCM 2CH 2 – LPCM 6CH 3 – LPCM 8CH 4 – Bitstream 5 – HD	Set HDMI IN 1 audio capabilities for EDID (LPCM 6CH): #EDID-AUDIO_1,2<CR>
EDID-AUDIO?	Get audio capabilities for EDID.	COMMAND #EDID-AUDIO?_io_index<CR> FEEDBACK ~nn@EDID-AUDIO_io_index,audio_format<CR><LF>	io_index – Number that indicates the specific input port: 1-4 audio_format – Audio block added to EDID: 0 – Auto 1 – LPCM 2CH 2 – LPCM 6CH 3 – LPCM 8CH 4 – Bitstream 5 – HD	Get HDMI IN 1 audio capabilities for EDID: #EDID-AUDIO?_1<CR>
EDID-CS	Set EDID color space. ① Set command might change the current EDID.	COMMAND #EDID-CS_<direction_type>.<port_format>.<port_index>.<signal_type>.<index>,cs_mode<CR> FEEDBACK ~nn@EDID-CS_<direction_type>.<port_format>.<port_index>.<signal_type>.<index>,cs_mode<CR><LF>	The following attributes comprise the signal ID: ▪ <direction_type> – Direction of the port: o IN – Input o OUT – Output ▪ <port_format> – Type of signal on the port: o HDMI o ANALOG_AUDIO ▪ <port_index> – 1-4 ▪ <signal_type> – Signal ID attribute: o AUDIO ▪ <index> 1 cs_mode – Color space 0 – RGB 1 – RGB + YUV444 2 – RGB + YUV422 3 – RGB + YUV444 + YUV422 4 – auto	Set HDMI IN 3 EDID color space to RGB (enabled): #EDID-CS_in.hdmi.3.audio.1,0<CR>
EDID-CS?	Get EDID color space. ① Get command might change the current EDID.	COMMAND #EDID-CS?_<direction_type>.<port_format>.<port_index>.<signal_type>.<index><CR> FEEDBACK ~nn@EDID-CS_<direction_type>.<port_format>.<port_index>.<signal_type>.<index>,cs_mode<CR><LF>	The following attributes comprise the signal ID: ▪ <direction_type> – Direction of the port: o IN – Input o OUT – Output ▪ <port_format> – Type of signal on the port: o HDMI o ANALOG_AUDIO ▪ <port_index> – 1-4 ▪ <signal_type> – Signal ID attribute: o AUDIO ▪ <index> 1 cs_mode – Color space 0 – RGB 1 – RGB + YUV444 2 – RGB + YUV422 3 – RGB + YUV444 + YUV422 4 – auto	Get EDID color space: #EDID-CS?_in.hdmi.3.audio.1,0<CR>
EDID-DC	Force removal of deep color on EDID or leaving it as in the original EDID.	COMMAND #EDID-DC_in_index,deep_color_state<CR> FEEDBACK Get: ~nn@EDID-DC_in_index,deep_color_state<CR><LF>	in_index – Number that indicates the specific input: 1-8 deep_color_state – 0 – Don't change 1 – Remove deep color	#EDID-DC_1,1<CR> ~01@ EDID-DC 1,1
EDID-DC?	Get the input's deep color removal status.	COMMAND #EDID-DC?_in_index<CR> FEEDBACK Get: ~nn@EDID-DC_in_index,deep_color_state<CR><LF>	in_index – Number that indicates the specific input: 1-8 deep_color_state – 0 – Don't change 1 – Remove deep color	#EDID-DC_1,1<CR> ~01@ EDID-DC 1,1

Function	Description	Syntax	Parameters/Attributes	Example
ETH-PORT	Set Ethernet port protocol. ① If the port number you enter is already in use, an w is returned. The port number must be within the following range: 0-(2 ¹⁶ -1).	COMMAND #ETH-PORT_ <u>port_type</u> , <u>port_id</u> <CR> FEEDBACK ~nn@ETH-PORT_ <u>port_type</u> , <u>port_id</u> <CR><LF>	<u>port_type</u> – TCP/UDP <u>port_id</u> – TCP/UDP port number (0 – 65535)	Set the Ethernet port protocol for TCP to port 12457: #ETH-PORT_ <u>0</u> , <u>12457</u> <CR>
ETH-PORT?	Get Ethernet port protocol.	COMMAND #ETH-PORT?_ <u>port_type</u> <CR> FEEDBACK ~nn@ETH-PORT?_ <u>port_type</u> , <u>port_id</u> <CR><LF>	<u>port_type</u> – TCP/UDP 0 – TCP 1 – UDP <u>port_id</u> – TCP / UDP port number (0 – 65535)	Get the Ethernet port protocol for UDP: #ETH-PORT?_ <u>1</u> <CR>
FACTORY	Reset device to factory default configuration. ① This command deletes all user data from the device. The deletion can take some time. Your device may require powering off and powering on for the changes to take effect.	COMMAND #FACTORY<CR> FEEDBACK ~nn@FACTORY_ <u>ok</u> <CR><LF>		Reset the device to factory default configuration: #FACTORY<CR>
FEATURE-LIST?	Get feature state according to the feature ID.	COMMAND #FEATURE-LIST?_ <u>feature_id</u> <CR> FEEDBACK ~nn@FEATURE-LIST?_ <u>feature_id</u> , <u>ir_state</u> <CR><LF>	<u>feature_id</u> – Feature ID) 1 – Maestro 2 – Room controller 3 – Maestro panel <u>ir_state</u> – IR interface 0 – disable 1 – enable	Get the room controller feature state (for the room controller 1): #FEATURE-LIST?_ <u>1</u> <CR>
GEDID	Get EDID support on certain input/output. ① For old devices that do not support this command, ~nn@ERR 002<CR><LF> is received.	COMMAND #GEDID_ <u>io_mode</u> , <u>in_index</u> <CR> FEEDBACK ~nn@GEDID_ <u>io_mode</u> , <u>in_index</u> , <u>size</u> , <u>edid_string</u> <CR><LF>	<u>io_mode</u> – Input/Output 0 – Input 1 – Output 2 – Default EDID <u>in_index</u> – Number that indicates the specific input: 1-4 <u>size</u> – Size of data to be sent from device, 0 means no EDID support <u>edid_string</u> – EDID content	Get EDID support information for input 1: #GEDID_ <u>0</u> , <u>1</u> <CR>
HDCP-MOD	Set HDCP mode for input. ① Set HDCP working mode on the device input: HDCP supported - HDCP_ON [default]. HDCP not supported - HDCP OFF. HDCP support changes following detected sink - MIRROR OUTPUT. When you define 3 as the mode, the HDCP status is defined according to the connected output in the following priority: OUT 1, OUT 2. If the connected display on OUT 2 supports HDCP, but OUT 1 does not, then HDCP is defined as not supported. If OUT 1 is not connected, then HDCP is defined by OUT 2.	COMMAND #HDCP-MOD_ <u>in_index</u> , <u>mode</u> <CR> FEEDBACK ~nn@HDCP-MOD_ <u>in_index</u> , <u>mode</u> <CR><LF>	<u>in_index</u> – Number that indicates the specific input: 1-8 <u>mode</u> – HDCP mode: 0 – HDCP Off 1 – HDCP On 2 – Follow Input 3 – Follow Output	Set the input HDCP-MODE of IN 1 to Off: #HDCP-MOD_ <u>1</u> , <u>0</u> <CR>

Function	Description	Syntax	Parameters/Attributes	Example
HDCP-MOD?	Get HDCP mode for input. ① Set HDCP working mode on the device input: HDCP supported - HDCP_ON [default]. HDCP not supported - HDCP OFF. HDCP support changes following detected sink - MIRROR OUTPUT.	COMMAND #HDCP-MOD?_in_index<CR> FEEDBACK ~nn@HDCP-MOD_in_index,mode<CR><LF>	in_index – Number that indicates the specific input: 1-8 mode – HDCP mode: 0 – HDCP Off 1 – HDCP On 2 – Follow Input 3 – Follow Output	Get the input HDCP-MODE of IN 1 HDMI: #HDCP-MOD?_1<CR>
HDCP-OUT	Set HDCP mode for output.	COMMAND #HDCP-OUT_out_index,mode<CR> FEEDBACK ~nn@HDCP-MOD_in_index,mode<CR><LF>	out_index – Number that indicates the specific output: 1-8 mode – HDCP mode: 0 – HDCP Off 1 – HDCP 1.4 2 – HDCP 2.2	Set the output HDCP-OUT mode of OUT 1 to Off: #HDCP-OUT_1,0<CR>
HDCP-OUT?	Get HDCP mode.	COMMAND #HDCP-OUT?_out_index<CR> FEEDBACK ~nn@HDCP-OUT_out_index,mode<CR><LF>	out_index – Number that indicates the specific output: 1-8 mode – HDCP mode: 0 – HDCP Off 1 – HDCP 1.4 2 – Follow 2.2	Get the input HDCP-OUT mode of IN 1 HDMI: #HDCP-OUT?_1<CR>
HDCP-STAT?	Get HDCP signal status. ① io_mode = 1 – get the HDCP signal status of the sink device connected to the specified output. io_mode = 0 – get the HDCP signal status of the source device connected to the specified input.	COMMAND #HDCP-STAT?_io_mode,in_index<CR> FEEDBACK ~nn@HDCP-STAT_io_mode,in_index,status<CR><LF>	io_mode – Input/Output 0 – Input 1 – Output io_index – Number that indicates the specific number of inputs or outputs (based on io_mode): 1-4 status – Signal encryption status - valid values On/Off 0 – HDCP Off 1 – HDCP On	Get the output HDCP-STATUS of IN 1: #HDCP-STAT?_0,1<CR>
HELP	Get command list or help for specific command.	COMMAND #HELP<CR> #HELP_cmd_name<CR> FEEDBACK 1. Multi-line: ~nn@Device_cmd_name,_cmd_name...<CR><LF> To get help for command use: HELP (COMMAND_NAME)<CR><LF> ~nn@HELP_cmd_name:<CR><LF> description<CR><LF> USAGE: usage<CR><LF>	cmd_name – Name of a specific command	Get the command list: #HELP<CR> To get help for AV-SW-TIMEOUT: HELP_av-sw-timeout<CR> >
LABEL	Set input/output label.	COMMAND #LABEL_io_mode,io_index,switch,label_txt<CR> FEEDBACK ~nn@LABEL_io_mode,io_index,switch,label_txt<CR><LF>	io_mode – Input/Output 0 – Input 1 – Output io_index – Number that indicates the specific input or output port: 1-8 switch – On/Off (enable/disable) custom label label_txt – Custom label string	Set input label for HDMI 3: #LABEL_0,3,1,HDMI<CR>
LABEL?	Get input/output label.	COMMAND #LABEL?_io_mode,io_index<CR> FEEDBACK ~nn@LABEL_io_mode,io_index,switch,label_txt<CR><LF>	io_mode – Input/Output 0 – Input 1 – Output io_index – Number that indicates the specific input or output port: 1-8 switch – On/Off (enable/disable) custom label label_txt – Custom label string	Get output label for HDMI 3: #LABEL?_1,3<CR>
LABEL-CFG	Set Label Config for output.	COMMAND #LABEL-CFG_io_mode,io_index,foregnd_color,backgnd_stat,position<CR> FEEDBACK ~nn@LABEL-CFG_io_mode,io_index,foregnd_color,backgnd_stat,position<CR><LF>	io_mode – 0 – Input 1 – Output io_index – Number that indicates the specific input or output port: 1-4 foregnd_color : 0 – White 1 – Black 2 – Green 3 – Purple backgnd_stat – 0 – Off 1 – On position – 0 – Top Left 1 – Top Right 2 – Bottom Left 3 – Bottom Right	Set HDMI 1 output label configuration to green on top left side of screen: #LABEL-CFG_1,1,2,1,0<CR>

Function	Description	Syntax	Parameters/Attributes	Example
LABEL-CFG?	Get Label Config for output.	COMMAND #LABEL-CFG?_io_mode,io_index<CR> FEEDBACK ~nn@LABEL-CFG_io_mode,io_index,foregnd_color,backgnd_ena,position<CR><LF>	io_mode – 0 – Input io_index – Number that indicates the specific input or output port: 1-8 foregnd_color: 0 – White 1 – Black 2 – Green 3 – Purple backgnd_stat – 0 – Off 1 – On position – 0 – Top Left 1 – Top Right 2 – Bottom Left 3 – Bottom Right	Get HDMI 1 output label configuration: #LABEL-CFG?_1,1<CR>
LOCK-EDID	Lock last read EDID.	COMMAND #LOCK-EDID_in_index,lock_mode<CR> FEEDBACK ~nn@LOCK-EDID_in_index,lock_mode<CR><LF>	in_index – Number that indicates the specific input: 1-8 lock_mode – On/Off 0 – Off unlocks EDID 1 – On locks EDID	Lock the last read EDID from the HDMI In 2 input: #LOCK-EDID_2,1<CR>
LOCK-EDID?	Get EDID lock state.	COMMAND #LOCK-EDID?_in_index,<CR> FEEDBACK ~nn@LOCK-EDID_in_index,lock_mode<CR><LF>	in_index – Number that indicates the specific input: 1-8 lock_mode – On/Off 0 – Off unlocks EDID 1 – On locks EDID	Get EDID lock state for Input 2: #LOCK-EDID?_2<CR>
LOCK-FP	Lock the front panel.	COMMAND #LOCK-FP_lock/unlock<CR> FEEDBACK ~nn@LOCK-FP_lock/unlock<CR><LF>	lock/unlock – On/Off 0 – Off unlocks front panel buttons or keyboard 1 – On locks front panel buttons or keyboard	Unlock front panel: #LOCK-FP_0<CR>
LOCK-FP?	Get the front panel lock state.	COMMAND #LOCK-FP?_<CR> FEEDBACK ~nn@LOCK-FP_lock/unlock<CR><LF>	lock/unlock – On/Off 0 – Off unlocks front panel buttons or keyboard 1 – On locks front panel buttons or keyboard	Get the front panel lock state: #LOCK-FP?<CR>
LOGIN (internal)	Set protocol permission. ① The permission system works only if security is enabled with the "SECUR" command. LOGIN allows the user to run commands with an End User or Administrator permission level. When the permission system is enabled, LOGIN enables running commands with the User or Administrator permission level. When set, login must be performed upon each connection. It is not mandatory to enable the permission system in order to use the device. In each device, some connections allow logging in to different levels. Some do not work with security at all. Connection may logout after timeout.	COMMAND #LOGIN_login_level,password<CR> FEEDBACK ~nn@LOGIN_login_level,password_ok<CR><LF> or ~nn@LOGIN_err_004<CR><LF> (if bad password entered)	login_level – Level of permissions required (User or Admin) password – Predefined password (by PASS command). Default password is an empty string	Set the protocol permission level to Admin (when the password defined in the PASS command is 33333): #LOGIN_admin,33333<CR>

Function	Description	Syntax	Parameters/Attributes	Example
LOGIN? (internal)	<p>Get current protocol permission level.</p> <p>i The permission system works only if security is enabled with the "SECUR" command.</p> <p>For devices that support security, LOGIN allows the user to run commands with an End User or Administrator permission level.</p> <p>In each device, some connections allow logging in to different levels. Some do not work with security at all.</p> <p>Connection may logout after timeout.</p>	<p>COMMAND #LOGIN?_<CR></p> <p>FEEDBACK ~nn@LOGIN_login_level<CR><LF></p>	login_level – Level of permissions required (User or Admin)	Get current protocol permission level: #LOGIN?<CR>
LOGOUT (internal)	<p>Cancel current permission level.</p> <p>i Logs out from End User or Administrator permission levels to Not Secure.</p>	<p>COMMAND #LOGOUT<CR></p> <p>FEEDBACK ~nn@LOGOUT_ok<CR><LF></p>		#LOGOUT<CR>
MODEL?	<p>Get device model.</p> <p>i This command identifies equipment connected to MTX3-88-SE and notifies of identity changes to the connected equipment. The Matrix saves this data in memory to answer REMOTE-INFO requests.</p>	<p>COMMAND #MODEL?_<CR></p> <p>FEEDBACK ~nn@MODEL_model_name<CR><LF></p>	model_name – String of up to 19 printable ASCII chars	Get the device model: #MODEL?_<CR>
MUTE	Set audio mute.	<p>COMMAND #MUTE_out_index,mute_mode<CR></p> <p>FEEDBACK ~nn@MUTE_out_index,mute_mode<CR><LF></p>	<p>out_index – Number that indicates the specific output: 1-8</p> <p>mute_mode – On/Off 0 – Off 1 – On</p>	Set Output 1 to mute: #MUTE_1,1<CR>
MUTE?	Get audio mute.	<p>COMMAND #MUTE?_out_index<CR></p> <p>FEEDBACK ~nn@MUTE_out_index,mute_mode<CR><LF></p>	<p>out_index – Number that indicates the specific output: 1-8</p> <p>mute_mode – On/Off 0 – Off 1 – On</p>	Get mute status of output 1 #MUTE_1?<CR>
NAME	<p>Set machine (DNS) name.</p> <p>i The machine name is not the same as the model name. The machine name is used to identify a specific machine or a network in use (with DNS feature on).</p>	<p>COMMAND #NAME_machine_name<CR></p> <p>FEEDBACK ~nn@NAME_machine_name<CR><LF></p>	machine_name – String of up to 15 alpha-numeric chars (can include hyphen, not at the beginning or end)	Set the DNS name of the device to room-442: #NAME_room-442<CR>
NAME?	<p>Get machine (DNS) name.</p> <p>i The machine name is not the same as the model name. The machine name is used to identify a specific machine or a network in use (with DNS feature on).</p>	<p>COMMAND #NAME?_<CR></p> <p>FEEDBACK ~nn@NAME_machine_name<CR><LF></p>	machine_name – String of up to 15 alpha-numeric chars (can include hyphen, not at the beginning or end)	Get the DNS name of the device: #NAME?_<CR>
NAME-RST	<p>Reset machine (DNS) name to factory default.</p> <p>i Factory default of machine (DNS) name is "KRAMER_" + 4 last digits of device serial number.</p>	<p>COMMAND #NAME-RST<CR></p> <p>FEEDBACK ~nn@NAME-RST_ok<CR><LF></p>		Reset the machine name (S/N last digits are 0102): #NAME-RST_kramer_0102<CR>

Function	Description	Syntax	Parameters/Attributes	Example
NET-CONFIG	<p>Set a network configuration.</p> <p>① Parameters [DNS1] and [DNS2] are optional.</p> <p>① For Backward compatibility, the id parameter can be omitted. In this case, the Network ID, by default, is 0, which is the Ethernet control port.</p> <p>① If the gateway address is not compliant to the subnet mask used for the host IP, the command will return an error. Subnet and gateway compliancy specified by RFC950.</p>	<p>COMMAND</p> <pre>#NET-CONFIG _netw_id,net_ip,net_mask,gateway,[dns1],[dns2]<CR></pre> <p>FEEDBACK</p> <pre>~nn@NET-CONFIG _netw_id,net_ip,net_mask,gateway<CR><LF></pre>	<p>netw_id – Network ID—the device network interface (if there are more than one). Counting is 0 based, meaning the control port is '0', additional ports are 1,2,3....</p> <p>net_ip – Network IP</p> <p>net_mask – Network mask</p> <p>gateway – Network gateway</p>	<p>Set the device network parameters to IP address 192.168.113.10, net mask 255.255.0.0, and gateway 192.168.0.1:</p> <pre>#NET-CONFIG _0,192.168.113.10,255.255.0.0,192.168.0.1<CR></pre>
NET-CONFIG?	<p>Get a network configuration.</p>	<p>COMMAND</p> <pre>#NET-CONFIG? _netw_id<CR></pre> <p>FEEDBACK</p> <pre>~nn@NET-CONFIG _netw_id,net_ip,net_mask,gateway<CR><LF></pre>	<p>netw_id – Network ID—the device network interface (if there are more than one). Counting is 0 based, meaning the control port is '0', additional ports are 1,2,3....</p> <p>net_ip – Network IP</p> <p>net_mask – Network mask</p> <p>gateway – Network gateway</p>	<p>Get network configuration:</p> <pre>#NET-CONFIG? _id<CR></pre>
NET-DHCP	<p>Set DHCP mode.</p> <p>① Only 1 is relevant for the mode value. To disable DHCP, the user must configure a static IP address for the device.</p> <p>Connecting Ethernet to devices with DHCP may take more time in some networks.</p> <p>To connect with a randomly assigned IP by DHCP, specify the device DNS name (if available) using the NAME command. You can also get an assigned IP by direct connection to USB or RS-232 protocol port, if available.</p> <p>For proper settings consult your network administrator.</p> <p>① For Backward compatibility, the id parameter can be omitted. In this case, the Network ID, by default, is 0, which is the Ethernet control port.</p>	<p>COMMAND</p> <pre>#NET-DHCP _netw_id,dhcp_state<CR></pre> <p>FEEDBACK</p> <pre>~nn@NET-DHCP _netw_id,dhcp_state<CR><LF></pre>	<p>netw_id – Network ID—the device network interface (if there are more than one). Counting is 0 based, meaning the control port is '0', additional ports are 1,2,3....</p> <p>dhcp_state –</p> <ul style="list-style-type: none"> 1 – Try to use DHCP. (If unavailable, use the IP address set by the factory or the net-ip command). 	<p>Enable DHCP mode for port 1, if available:</p> <pre>#NET-DHCP _1,1<CR></pre>
NET-DHCP?	<p>Get DHCP mode.</p> <p>① For Backward compatibility, the id parameter can be omitted. In this case, the Network ID, by default, is 0, which is the Ethernet control port.</p>	<p>COMMAND</p> <pre>#NET-DHCP? _netw_id<CR></pre> <p>FEEDBACK</p> <pre>~nn@NET-DHCP _netw_id,dhcp_mode<CR><LF></pre>	<p>netw_id – Network ID—the device network interface (if there are more than one). Counting is 0 based, meaning the control port is '0', additional ports are 1,2,3....</p> <p>dhcp_mode –</p> <ul style="list-style-type: none"> 0 – Do not use DHCP. Use the IP set by the factory or using the net-ip or net-config command. 1 – Try to use DHCP. If unavailable, use the IP set by the factory or using the net-ip or net-config command. 	<p>Get DHCP mode for port 1:</p> <pre>#NET-DHCP? _1<CR></pre>

Function	Description	Syntax	Parameters/Attributes	Example
NET-GATE	Set gateway IP. ① A network gateway connects the device via another network and maybe over the Internet. Be careful of security issues. For proper settings consult your network administrator.	COMMAND #NET-GATE_ <u>ip_address</u> <CR> FEEDBACK ~nn@NET-GATE_ <u>ip_address</u> <CR><LF>	<u>ip_address</u> – Format: xxx.xxx.xxx.xxx	Set the gateway IP address to 192.168.0.1: #NET-GATE_ <u>192.168.000.001</u> <CR>
NET-GATE?	Get gateway IP. ① A network gateway connects the device via another network and maybe over the Internet. Be aware of security problems.	COMMAND #NET-GATE?_ <u><CR></u> FEEDBACK ~nn@NET-GATE_ <u>ip_address</u> <CR><LF>	<u>ip_address</u> – Format: xxx.xxx.xxx.xxx	Get the gateway IP address: #NET-GATE?_ <u><CR></u>
NET-IP	Set IP address. ① For proper settings consult your network administrator.	COMMAND #NET-IP_ <u>ip_address</u> <CR> FEEDBACK ~nn@NET-IP_ <u>ip_address</u> <CR><LF>	<u>ip_address</u> – Format: xxx.xxx.xxx.xxx	Set the IP address to 192.168.1.39: #NET-IP_ <u>192.168.001.039</u> <CR>
NET-IP?	Get IP address.	COMMAND #NET-IP?_ <u><CR></u> FEEDBACK ~nn@NET-IP_ <u>ip_address</u> <CR><LF>	<u>ip_address</u> – Format: xxx.xxx.xxx.xxx	Get the IP address: #NET-IP?_ <u><CR></u>
NET-MAC?	Get MAC address. ① For backward compatibility, the <u>id</u> parameter can be omitted. In this case, the Network ID, by default, is 0, which is the Ethernet control port.	COMMAND #NET-MAC?_ <u>id</u> <CR> FEEDBACK ~nn@NET-MAC_ <u>id,mac_address</u> <CR><LF>	<u>id</u> – Network ID—the device network interface (if there are more than one). Counting is 0 based, meaning the control port is '0', additional ports are 1,2,3... <u>mac_address</u> – Unique MAC address. Format: XX-XX-XX-XX-XX-XX where X is hex digit	#NET-MAC?_ <u>id</u> <CR>
NET-MASK	Set subnet mask. ① For proper settings consult your network administrator.	COMMAND #NET-MASK_ <u>net_mask</u> <CR> FEEDBACK ~nn@NET-MASK_ <u>net_mask</u> <CR><LF>	<u>net_mask</u> – Format: xxx.xxx.xxx.xxx	Set the subnet mask to 255.255.0.0: #NET-MASK_ <u>255.255.000.000</u> <CR>
NET-MASK?	Get subnet mask.	COMMAND #NET-MASK?_ <u><CR></u> FEEDBACK ~nn@NET-MASK_ <u>net_mask</u> <CR><LF>	<u>net_mask</u> – Format: xxx.xxx.xxx.xxx	Get the subnet mask: #NET-MASK?_ <u><CR></u>
PASS	Set password for login level.	COMMAND #PASS_ <u>login_level,password</u> <CR> FEEDBACK ~nn@PASS_ <u>login_level,password</u> <CR><LF>	<u>login_level</u> – Level of login to set (End User or Administrator). <u>password</u> – Password for the <u>login_level</u> . Up to 15 printable ASCII chars	Set the password for the Admin protocol permission level to 33333: #PASS_ <u>admin,33333</u> <CR>
PASS?	Get password for login level.	COMMAND #PASS?_ <u>login_level</u> <CR> FEEDBACK ~nn@PASS_ <u>login_level,password</u> <CR><LF>	<u>login_level</u> – Level of login to set (End User or Administrator). <u>password</u> – Password for the <u>login_level</u> . Up to 15 printable ASCII chars	Get the password for the Admin protocol permission level: #PASS?_ <u>admin</u> <CR>
PROT-VER?	Get device protocol version.	COMMAND #PROT-VER?_ <u><CR></u> FEEDBACK ~nn@PROT-VER_ <u>3000:version</u> <CR><LF>	<u>version</u> – XX.XX where X is a decimal digit	Get the device protocol version: #PROT-VER?_ <u><CR></u>
RESET	Reset device	COMMAND #RESET<CR> FEEDBACK ~nn@RESET_ <u>ok</u> <CR><LF>		Reset the device: #RESET<CR>
ROUTE	Set layer routing. ① This command replaces all other routing commands.	COMMAND #ROUTE_ <u>layer_type,out_index,in_index</u> <CR> FEEDBACK ~nn@ROUTE_ <u>layer_type,out_index</u> <CR><LF>	<u>layer_type</u> Layer Enumeration 1 – Video 2 – Audio 3 – Data 4 – IR 5 – USB <u>out_index</u> Video:1 – 8, *=All, x=disconnect Audio Embed:1 - 8 Audio Analog:1,2,9,10 RS-232: 1,2 IR: 1,2 USB: 1,2 <u>In_index</u> – Video:1 – 8 Audio Embed:1 - 8 RS-232: 1,11 IR: 1, USB: 1,	Route video IN 2 to video OUT 4: #ROUTE_ <u>1,4,2</u> <CR>

Function	Description	Syntax	Parameters/Attributes	Example
ROUTE?	Get layer routing. ① This command replaces all other routing commands.	COMMAND #ROUTE?_layer_type,out_index<CR> FEEDBACK ~nn@ROUTE_ layer_type,out_index,in_index<CR><LF>	layer_type Layer Enumeration 1 – Video 2 – Audio 3 – Data 4 – IR 5 – USB out_index Video:1 – 8, *=All, x=disconnect Audio Embed:1 - 8 Audio Analog:1,2,9,10 RS-232: 1,2 IR: 1,2 USB: 1,2 In_index – Video:1 – 8 Audio Embed:1 - 8 RS-232: 1,11 IR: 1, USB: 1,	Get the layer routing: #ROUTE?_layer,dest<CR>
SECUR	Start/stop security. ① The permission system works only if security is enabled with the "SECUR" command.	COMMAND #SECUR_security_state<CR> FEEDBACK ~nn@SECUR_security_state<CR><LF>	security_state – Security state 0 – OFF (disables security) 1 – ON (enables security)	Enable the permission system: #SECUR_0<CR>
SECUR?	Get current security state. ① The permission system works only if security is enabled with the "SECUR" command.	COMMAND #SECUR?_<CR> FEEDBACK ~nn@SECUR_security_state<CR><LF>	security_state – Security state 0 – OFF (disables security) 1 – ON (enables security)	Get current security state: #SECUR?_1<CR>
SIGNAL?	Get input signal status.	COMMAND #SIGNAL?_in_index<CR> FEEDBACK ~nn@SIGNAL_in_index,status<CR><LF>	in_index – Number that indicates the specific input: 1-8 status – Signal status according to signal validation: 0 – Off 1 – On	Get the input signal lock status of IN 1: #SIGNAL?_1<CR>
SN?	Get device serial number.	COMMAND #SN?_<CR> FEEDBACK ~nn@SN_serial_num<CR><LF>	serial_num – 14 decimal digits, factory assigned	Get the device serial number: #SN?_<CR>
VERSION?	Get firmware version number.	COMMAND #VERSION?_<CR> FEEDBACK ~nn@VERSION_firmware_version<CR><LF>	firmware_version – XX.XX.XXXX where the digit groups are: major.minor.build version	Get the device firmware version number: #VERSION?_<CR>
VID-RES	Set output resolution. ① "Set" command with is_native=ON sets native resolution on selected output (resolution index sent = 0). Device sends as answer actual VIC ID of native resolution. To use "custom resolutions" (entries 100-105 In View Modes), define them using the DEF-RES command.	COMMAND #VID-RES_io_mode,io_index,is_native,resolution<CR> FEEDBACK ~nn@VID-RES_io_mode,io_index,is_native,resolution<CR><LF>	io_mode – Input/Output 0 – Input 1 – Output io_index – Number that indicates the specific input or output port: 1-N (N= the total number of input or output ports) is_native – Native resolution flag 0 – Off 1 – On resolution – Resolution index 4=1280x720p@60Hz 5=1920x1080i@59.94Hz/60Hz 16=1920x1080p@59.94Hz/60Hz 19=1280x720p@50Hz 31=1920x1080p@50Hz 32=1920x1080p@23.97Hz/24Hz 33=1920x1080p@25Hz 34=1920x1080p@29.97Hz/30Hz 60=1280x720p@23.97Hz/24Hz 61=1280x720p@25Hz 62=1280x720p@29.97Hz/30Hz 66=1024x768@60Hz 67=1280x768p@60Hz 68=1280x1024p@60Hz 69=1600x1200p@60Hz 70=1680x1050p@60Hz 71=1920x1200@60Hz 72=3840x2160p@24Hz 73=3840x2160p@25Hz 74=3840x2160p@30Hz 75=3840x2160p@50Hz 76=3840x2160p@60Hz 77=1366x768p@60 78=1360x768p@60 79=2560x1440p@60 80=2560x1600p@60	Set output 1 resolution to 1280x720p@50Hz: #VID-RES_1,1,1,19<CR>

Function	Description	Syntax	Parameters/Attributes	Example
VID-RES?	Get output resolution. ① "Get" command with is_native=ON returns native resolution VIC, with is_native=OFF returns current resolution. To use "custom resolutions" (entries 100-105 In View Modes), define them using the DEF-RES command.	COMMAND #VID-RES?_io_mode,io_index,is_native<CR> FEEDBACK ~nn@VID-RES?_io_mode,io_index,is_native,resolution<CR><LF>	io_mode – Input/Output 0 – Input 1 – Output io_index – Number that indicates the specific input or output port: 1-N (N= the total number of input or output ports) is_native – Native resolution flag 0 – Off 1 – On resolution – Resolution index 4=1280x720p@60Hz 5=1920x1080i@59.94Hz/60Hz 16=1920x1080p@59.94Hz/60Hz 19=1280x720p@50Hz 31=1920x1080p@50Hz 32=1920x1080p@23.97Hz/24Hz 33=1920x1080p@25Hz 34=1920x1080p@29.97Hz/30Hz 60=1280x720p@23.97Hz/24Hz 61=1280x720p@25Hz 62=1280x720p@29.97Hz/30Hz 66=1024x768@60Hz 67=1280x768p@60Hz 68=1280x1024p@60Hz 69=1600x1200p@60Hz 70=1680x1050p@60Hz 71=1920x1200@60Hz 72=3840x2160p@24Hz 73=3840x2160p@25Hz 74=3840x2160p@30Hz 75=3840x2160p@50Hz 76=3840x2160p@60Hz 77=1366x768p@60 78=1360x768p@60 79=2560x1440p@60 80=2560x1600p@60	Set output resolution: #VID-RES?_1,1,1<CR>
VIEW-MOD	Set view mode.	COMMAND #VIEW-MOD_mode<CR> FEEDBACK ~nn@VIEW-MOD_mode<CR><LF>	mode – View Modes 13 – Matrix (Fast switching) 14 –Quad 15 –PIP 16 –PIP2	Set view mode to PIP: #VIEW-MOD_15<CR>
VIEW-MOD?	Get view mode.	COMMAND #VIEW-MOD?_mode<CR> FEEDBACK ~nn@VIEW-MOD_mode<CR><LF>	mode – View Modes 13 – Matrix (Fast switching) 14 –Quad 15 –PIP 16 –PIP2	Get view mode: #VIEW-MOD?_mode<CR>
VMUTE	Set enable/disable video on output.	COMMAND #VMUTE_out_index,flag<CR> FEEDBACK ~nn@VMUTE_out_index,flag<CR><LF>	out_index – Number that indicates the specific output: 1-N (N= the total number of outputs): 1-8 flag – Video Mute 0 – Video enabled 1 – Video disabled	Disable the video output on OUT 2: #VMUTE_2,0<CR>
VMUTE?	Get video on output status.	COMMAND #VMUTE?_out_index<CR> FEEDBACK ~nn@VMUTE_out_index,flag<CR><LF>	out_index – Number that indicates the specific output: 1-N (N= the total number of outputs): 1-8 flag – Video Mute 0 – Video enabled 1 – Video disabled	Get video on output status: #VMUTE?_out_index<CR>
WEB-ATTR	Set Web attributes values	COMMAND #WEB-ATTR_key,value<CR> FEEDBACK ~nn@WEB-ATTR_key,value<CR><LF>	key – Overlay order number value – Overlay order number	Set web attributes: #WEB-ATTR_1,1<CR>
WEB-ATTR?	Get Web attributes value.	COMMAND #WEB-ATTR?_key<CR> FEEDBACK ~nn@WEB-ATTR?_key,value<CR><LF>	key – Overlay order number value – Overlay order number	Get web attributes: #WEB-ATTR?_1<CR>
WND-ASPECT	Set window aspect ratio.	COMMAND #WND-ASPECT_mode,out_index,wind_id,aspect_ratio<CR> FEEDBACK ~nn@WND-ASPECT_mode,out_index,wind_id,aspect_ratio<CR><LF>	mode – the active mode: 13 – Matrix (Fast switching) 14 –Quad 15 –PIP 16 –PIP2 out_index – 1 – 8 wind_id – Matrix Mode:1 – 8 Quad:1 & 5 PIP:1, 3,5 & 7 PIP2: 1 & 5 aspect_ratio – 1 – Full 2 – Best fit	Set window aspect ratio in the quad mode to full: #WND-ASPECT?_14,1,1,1,<CR>

Function	Description	Syntax	Parameters/Attributes	Example
WND-ASPECT?	Get window aspect ratio.	COMMAND #WND-ASPECT?_mode,out_index,wind_id<CR> FEEDBACK ~nn@WND-ASPECT_mode,out_index,wind_id,aspect_ratio<CR><LF>	mode – the active mode: 13 – Matrix (Fast switching) 14 –Quad 15 –PIP 16 –PIP2 out_index – 1 - 8 wind_id – Matrix Mode:1 – 8 Quad:1 & 5 PIP:1, 3,5 & 7 PIP2: 1 & 5 aspect_ratio – 1 – Full 2 – Best fit	Get window aspect ratio in the quad mode: #WND-ASPECT?_14,1,1<CR> >
WND-DEFAULT	Set default for window.	COMMAND #WND-default_mode,wind_id<CR> FEEDBACK ~nn@WND-default_mode,wind_id<CR><LF>	mode – the active mode: 13 – Matrix (Fast switching) 14 –Quad 15 –PIP 16 –PIP2 wind_id – Number that indicates the specific window (number of windows changes for each mode): Matrix Mode:1 – 8 Quad:1 & 5 PIP:1, 3,5 & 7 PIP2: 1 & 5	Set default for PIP1: #WND-BRD_15,1<CR>
WND-ENABLE	Set window enable status.	COMMAND #WND-ENABLE_mode,out_index,wind_id,status<CR> FEEDBACK ~nn@WND-ENABLE_mode,out_index,wind_id,status<CR><LF>	mode – the active mode: 13 – Matrix (Fast switching) 14 –Quad 15 –PIP 16 –PIP2 out_index – 1 - 8 wind_id – Number that indicates the specific window (number of windows changes for each mode): Matrix Mode:1 – 8 Quad:1 & 5 PIP:1, 3,5 & 7 PIP2: 1 & 5 status – 0 – Vide disabled 1 – Video enabled 2 – Blank picture	Set window 1 to disable in Quad mode: #WND-ENABLE_14,1,1,0<CR> R>
WND-ENABLE?	Get window enable status.	COMMAND #WND-ENABLE?_mode,out_index,wind_id<CR> FEEDBACK ~nn@WND-ENABLE_mode,out_index,wind_id,status<CR><LF>	mode – the active mode: 13 – Matrix (Fast switching) 14 –Quad 15 –PIP 16 –PIP2 out_index – 1 - 8 wind_id – Number that indicates the specific window (number of windows changes for each mode): Matrix Mode:1 – 8 Quad:1 & 5 PIP:1, 3,5 & 7 PIP2: 1 & 5 status – 0 – Vide disabled 1 – Video enabled 2 – Blank picture	Get window 1 enable status in Quad mode: #WND-ENABLE?_14,1,1<CR> >

Function	Description	Syntax	Parameters/Attributes	Example
WND-SRC	Set window source.	COMMAND #WND-SRC_ mode, layer_type, out_index, wind_id, in_index <CR> FEEDBACK ~nn@WND-SRC_ mode, layer_type, out_index, wind_id, in_index <CR> <LF>	mode – The active mode: 13 – Matrix (Fast switching) 14 –Quad 15 –PIP 16 –PIP2 Layer_type – 1 – Video 2 – Audio 3 – Data 4 – IR 5 – USB out_index Video: 1 – 8 Audio Embed: 1 - 8 Audio Analog: 1,2,9,10 RS-232: 1,2 IR: 1,2 USB: 1,2 wind_id – Number that indicates the specific window (number of windows changes for each mode): Matrix Mode: 1 – 8 Quad: 1 & 5 PIP: 1, 3, 5 & 7 PIP2: 1 & 5 In_index – Video: 1 – 8 Audio Embed: 1 - 8 RS-232: 1,11 IR: 1, USB: 1,	Set window HDMI 2 video source for Window 1 in quad mode: WND-SRC_14,1,1,1,2<CR>
WND-SRC?	Get window source.	COMMAND #WND-SRC?_ mode, layer_type, out_index, wind_id <CR> FEEDBACK ~nn@WND-SRC_ mode, layer_type, out_index, wind_id, in_index <CR> <LF>	mode – The active mode: 13 – Matrix (Fast switching) 14 –Quad 15 –PIP 16 –PIP2 Layer_type – 1 – Video 2 – Audio 3 – Data 4 – IR 5 – USB out_index Video: 1 – 8 Audio Embed: 1 - 8 Audio Analog: 1,2,9,10 RS-232: 1,2 IR: 1,2 USB: 1,2 wind_id – Number that indicates the specific window (number of windows changes for each mode): Matrix Mode: 1 – 8 Quad: 1 & 5 PIP: 1, 3, 5 & 7 PIP2: 1 & 5 In_index – Video: 1 – 8 Audio Embed: 1 - 8 RS-232: 1,11 IR: 1, USB: 1,	Get window video source for Window 1 in quad mode: WND-SRC?_14,1,1,1,1<CR>
W-SATURATION	Set image saturation per output. <i>i</i> Value limits can vary for different devices. Value is a property of input connected to current output. Changing input source might cause changes in this value (refer device definitions). In devices that enable showing multiple outputs on one display – each in a separate window – this command relates only to the window associated with the output indicated in the out-index parameter.	COMMAND #W-SATURATION_ in_index, value <CR> FEEDBACK ~nn@W-SATURATION_ in_index, value <CR> <LF>	in_index – Number that indicates the specific input: 1-8 value – Saturation value (0-100)	Set saturation for input 1 to 50: #W-SATURATION_1,50<CR>

Function	Description	Syntax	Parameters/Attributes	Example
W-SATURATION?	<p>Get image saturation per output.</p> <p>i Value limits can vary for different devices.</p> <p>Value is a property of input connected to current output. Changing input source might cause changes in this value (refer device definitions).</p> <p>In devices that enable showing multiple outputs on one display – each in a separate window – this command relates only to the window associated with the output indicated in the out-index parameter.</p>	<p>COMMAND</p> <pre>#W-SATURATION?_in_index<CR></pre> <p>FEEDBACK</p> <pre>~nn@W-SATURATION_in_index,value<CR><LF></pre>	<p>in_index – Number that indicates the specific input: 1-8</p> <p>value – Saturation value (0-100)</p>	<p>Get saturation for input 1:</p> <pre>#W-SATURATION?_1<CR></pre>
X-AUD-LVL	<p>Set audio level of a specific signal.</p> <p>i This is an Extended Protocol 3000 command.</p>	<p>COMMAND</p> <pre>#X-AUD-LVL_<direction_type>.<port_format>.<port_index>.<signal_type>.<index>,audio_level<CR></pre> <p>FEEDBACK</p> <pre>~nn@X-AUD-LVL_<direction_type>.<port_format>.<port_index>.<signal_type>.<index>,audio_level<CR><LF></pre>	<p>The following attributes comprise the signal ID:</p> <ul style="list-style-type: none"> ▪ <direction_type> – Direction of the port: <ul style="list-style-type: none"> ○ IN – Input ○ OUT – Output ▪ <port_format> – Type of signal on the port: <ul style="list-style-type: none"> ○ HDMI ○ HDBT ○ ANALOG_AUDIO ▪ <port_index> – The port number as printed on the front or rear panel ▪ <signal_type> – Signal ID attribute: <ul style="list-style-type: none"> ○ AUDIO ▪ <index> – Indicates a specific channel number when there are multiple channels of the same type <p>audio_level – Audio level in dB depending of the ability of the product</p>	<p>Set the audio level of a specific signal to 10:</p> <pre>#X-AUD-LVL_in.analog_audio.5.audio.1,10<CR></pre>
X-AUD-LVL?	<p>Get audio level of a specific signal.</p> <p>i This is an Extended Protocol 3000 command.</p>	<p>COMMAND</p> <pre>#X-AUD-LVL?_<direction_type>.<port_format>.<port_index>.<signal_type>.<index><CR></pre> <p>FEEDBACK</p> <pre>~nn@X-AUD-LVL_<direction_type>.<port_format>.<port_index>.<signal_type>.<index>,audio_level<CR><LF></pre>	<p>The following attributes comprise the signal ID:</p> <ul style="list-style-type: none"> ▪ <direction_type> – Direction of the port: <ul style="list-style-type: none"> ○ IN – Input ○ OUT – Output ▪ <port_format> – Type of signal on the port: <ul style="list-style-type: none"> ○ HDMI ○ HDBT ○ ANALOG_AUDIO ▪ <port_index> – The port number as printed on the front or rear panel ▪ <signal_type> – Signal ID attribute: <ul style="list-style-type: none"> ○ AUDIO ▪ <index> – Indicates a specific channel number when there are multiple channels of the same type <p>audio_level – Audio level in dB depending of the ability of the product</p>	<p>Get the audio level of a specific signal:</p> <pre>#X-AUD-LVL?_out.analog_audio.1.audio.1<CR></pre>
X-AUD-LVL-RANGE?	<p>Get the range of audio level in the product.</p> <p>i This is an Extended Protocol 3000 command.</p>	<p>COMMAND</p> <pre>#X-AUD-LVL-RANGE?_<direction_type>.<port_format>.<port_index>.<signal_type>.<index><CR></pre> <p>FEEDBACK</p> <pre>~nn@X-AUD-LVL-RANGE_<direction_type>.<port_format>.<port_index>.<signal_type>.<index>,audio_level_range<CR><LF></pre>	<p>The following attributes comprise the signal ID:</p> <ul style="list-style-type: none"> ▪ <direction_type> – Direction of the port: <ul style="list-style-type: none"> ○ IN – Input ○ OUT – Output ▪ <port_format> – Type of signal on the port: <ul style="list-style-type: none"> ○ HDMI ○ HDBT ○ ANALOG_AUDIO ▪ <port_index> – The port number as printed on the front or rear panel ▪ <signal_type> – Signal ID attribute: <ul style="list-style-type: none"> ○ AUDIO 	<p>get the analog output 3 audio level range:</p> <pre>#X-AUD-LVL-RANGE?_out.analog_audio.3.audio.1<CR></pre>

X-PRST-CURR?	<p>Get the current preset loaded per type.</p> <p>To get the list of preset types existing in your product use the command: X-PRST-TYPES?</p> <p>This is an Extended Protocol 3000 command.</p>	<p>COMMAND #X-PRST-CURR?_presets_type<CR></p> <p>FEEDBACK ~nn@X-PRST-CURR_<presets_type, [presets_id:name:lock_state]<CR><LF></p>	<ul style="list-style-type: none"> ▪ presets_type – <ul style="list-style-type: none"> ○ System Preset – IOCONFIG.SYSTEM ○ Snapshot – IOCONFIG.SYSTEM.MIXER ▪ <presets_id> –preset index ▪ <name> – the name of the preset in URL encode format ▪ <lock_state> – <ul style="list-style-type: none"> ○ ON ○ OFF 	<p>Get current mixer preset: X-PRST-CURR?_IOCONFIG.SYSTEM.MIXER<CR></p>
X-PRST-LOCK	<p>Set LOCK state of a preset per type.</p> <p>i this is an extended preset command using preset type as first parameter. This is used essentially when we have different types of Presets inside the same system.</p> <p>To get the list of preset types existing in your product use the command: X-PRST-TYPES?</p> <p>This is an Extended Protocol 3000 command.</p>	<p>COMMAND #X-PRST-LOCK_preset_type,preset_id,lock_state<CR></p> <p>FEEDBACK ~nn@X-PRST-LOCK_<presets_type, [presets_id:name:lock_state]<CR><LF></p>	<ul style="list-style-type: none"> ▪ presets_type – <ul style="list-style-type: none"> ○ System Preset – IOCONFIG.SYSTEM ○ Snapshot – IOCONFIG.SYSTEM.MIXER ▪ <presets_id> –preset index ▪ <lock_state> – <ul style="list-style-type: none"> ○ ON ○ OFF 	<p>lock mixer preset 9: X-PRST-LOCK_IOCONFIG.SYSTEM.MIXER,9<CR></p>
X-PRST-LOCK?	<p>Get LOCK state of a preset per type.</p> <p>i this is an extended preset command using preset type as first parameter. This is used essentially when we have different types of Presets inside the same system.</p> <p>To get the list of preset types existing in your product use the command: X-PRST-TYPES?</p> <p>This is an Extended Protocol 3000 command.</p>	<p>COMMAND #X-PRST-LOCK?_presets_type,preset_id,lock_state<CR></p> <p>FEEDBACK ~nn@X-PRST-LOCK_<presets_type, [presets_id:name:lock_state]<CR><LF></p>	<ul style="list-style-type: none"> ▪ presets_type – <ul style="list-style-type: none"> ○ System Preset – IOCONFIG.SYSTEM ○ Snapshot – IOCONFIG.SYSTEM.MIXER ▪ <presets_id> –preset index ▪ <lock_state> – <ul style="list-style-type: none"> ○ ON ○ OFF 	<p>Get lock mixer preset 9 status: X-PRST-LOCK_IOCONFIG.SYSTEM.MIXER,9<CR></p>
X-PRST-LST?	<p>Get the preset list of a specific preset type.</p> <p>i this is an extended preset command using preset type as first parameter. This is used essentially when we have different types of Presets inside the same system.</p> <p>To get the list of preset types existing in your product use the command: X-PRST-TYPES?</p> <p>This is an Extended Protocol 3000 command.</p>	<p>COMMAND #X-PRST-LST?_presets_type<CR></p> <p>FEEDBACK ~nn@X-PRST-LST_<presets_type, [presets_id:name:lock_state]<CR><LF></p>	<ul style="list-style-type: none"> ▪ presets_type – <ul style="list-style-type: none"> ○ System Preset – IOCONFIG.SYSTEM ○ Snapshot – IOCONFIG.SYSTEM.MIXER ▪ <name> – the name of the preset ▪ <lock_state> – <ul style="list-style-type: none"> ○ ON ○ OFF 	<p>Get the IO configuration list: X-PRST-LST?_IOCONFIG<CR></p> <p>[[1:4x16:ON], [2:6x14:ON], [3:8x12:ON], [4:10x10:ON], [5:12x8:ON], [6:14x6:ON], [7:16x4:ON]]</p>
X-PRST-NAME	<p>Set the name of a preset per type.</p> <p>i this is an extended preset command using preset type as first parameter. This is used essentially when we have different types of Presets inside the same system.</p> <p>To get the list of preset types existing in your product use the command: X-PRST-TYPES?</p> <p>This is an Extended Protocol 3000 command.</p>	<p>COMMAND #X-PRST-NAME_preset_type,preset_id,name<CR></p> <p>FEEDBACK ~nn@X-PRST-NAME_preset_type,preset_id,name<CR><LF></p>	<ul style="list-style-type: none"> ▪ presets_type – <ul style="list-style-type: none"> ○ System Preset – IOCONFIG.SYSTEM ○ Snapshot – IOCONFIG.SYSTEM.MIXER ▪ presets_id – preset index ▪ name – the name of the preset in URL encode format (no spaces) 	<p>Set the name of a preset (per type): X-PRST-NAME_IOCONFIG.SYSTEM.MIXER,9,ROOM1<CR></p>

X-PRST-NAME?	<p>Get the name of a preset per type.</p> <p>i this is an extended preset command using preset type as first parameter. This is used essentially when we have different types of Presets inside the same system.</p> <p>To get the list of preset types existing in your product use the command: X-PRST-TYPES?</p> <p>This is an Extended Protocol 3000 command.</p>	<p>COMMAND #X-PRST-NAME?<i>pres</i>type,preset_id,name<CR></p> <p>FEEDBACK ~nn@X-PRST-NAME<i>pres</i>type,preset_id,name<CR><LF></p>	<ul style="list-style-type: none"> ▪ pres<i>type</i> – <ul style="list-style-type: none"> ○ System Preset – IOCONFIG.SYSTEM ○ Snapshot – IOCONFIG.SYSTEM.MIXER ▪ pres<i>id</i> – preset index ▪ name – the name of the preset in URL encode format 	<p>Get the name of a preset (per type): X-PRST-NAME?<i>IOCONFIG.SYSTEM.MIXER,9</i><CR></p>
X-PRST-RCL	<p>Recall saved preset list per type.</p> <p>i this is an extended preset command using preset type as first parameter. This is used essentially when we have different types of Presets inside the same system.</p> <p>To get the list of preset types existing in your product use the command: X-PRST-TYPES?</p> <p>This is an Extended Protocol 3000 command.</p>	<p>COMMAND #X-PRST-RCL<i>pres</i>type,preset_id<CR></p> <p>FEEDBACK ~nn@X-PRST-RCL<i>pres</i>type,preset_id<CR><LF></p>	<ul style="list-style-type: none"> ▪ pres<i>type</i> – <ul style="list-style-type: none"> ○ System Preset – IOCONFIG.SYSTEM ○ Snapshot – IOCONFIG.SYSTEM.MIXER ▪ pres<i>id</i> – preset index 	<p>Recall mixer preset 8: X-PRST-RCL<i>IOCONFIG.SYSTEM.MIXER,8</i><CR></p>
X-PRST-RCL-LAST	<p>Recall LAST preset per type, this command just retrieves the last preset loaded from the history of preset activity and RECALLS it.</p> <p>i this is an extended preset command using preset type as first parameter. This is used essentially when we have different types of Presets inside the same system.</p> <p>To get the list of preset types existing in your product use the command: X-PRST-TYPES?</p> <p>This is an Extended Protocol 3000 command.</p>	<p>COMMAND #X-PRST-RCL-LAST<i>pres</i>type <CR></p> <p>FEEDBACK ~nn@X-PRST-RCL-LAST<i>pres</i>type,preset_id<CR><LF></p>	<ul style="list-style-type: none"> ▪ pres<i>type</i> – <ul style="list-style-type: none"> ○ System Preset – IOCONFIG.SYSTEM ○ Snapshot – IOCONFIG.SYSTEM.MIXER ▪ pres<i>id</i> – preset index 	<p>Recall the last mixer preset: X-PRST-RCL-LAST<i>IOCONFIG.SYSTEM.MIXER</i><CR></p>
X-PRST-RCL-NEXT	<p>Recall NEXT preset per type, this command increments by one the current preset id loaded and loads it. If the index is the highest, recall will fail.</p> <p>i this is an extended preset command using preset type as first parameter. This is used essentially when we have different types of Presets inside the same system.</p> <p>To get the list of preset types existing in your product use the command: X-PRST-TYPES?</p> <p>This is an Extended Protocol 3000 command.</p>	<p>COMMAND #X-PRST-RCL-NEXT<i>pres</i>type<CR></p> <p>FEEDBACK ~nn@X-PRST-RCL-NEXT<i>pres</i>type,preset_id<CR><LF></p>	<ul style="list-style-type: none"> ▪ pres<i>type</i> – <ul style="list-style-type: none"> ○ System Preset – IOCONFIG.SYSTEM ○ Snapshot – IOCONFIG.SYSTEM.MIXER ▪ pres<i>id</i> – preset index 	<p>Recall next mixer preset: X-PRST-RCL-NEXT<i>IOCONFIG.SYSTEM.MIXER</i><CR></p>

X-PRST-RCL-PREV	<p>Recall previous preset per type, this command increments by one the current preset id loaded and loads it. If the index is the lowest, recall will fail.</p> <p>i this is an extended preset command using preset type as first parameter. This is used essentially when we have different types of Presets inside the same system.</p> <p>To get the list of preset types existing in your product use the command: X-PRST-TYPES?</p> <p>This is an Extended Protocol 3000 command.</p>	<p>COMMAND #X-PRST-RCL-PREV, preset_type<CR></p> <p>FEEDBACK ~nn@X-PRST-RCL-PREV, preset_type, preset_id<CR><LF></p>	<ul style="list-style-type: none"> ▪ preset_type – <ul style="list-style-type: none"> ○ System Preset – IOCONFIG.SYSTEM ○ Snapshot – IOCONFIG.SYSTEM.MIXER ▪ preset_id – preset index 	<p>Recall previous mixer preset: X-PRST-RCL-PREV, IOCONFIG.SYSTEM.MIXER<CR></p>
X-PRST-RESET	<p>Reset preset per type</p> <p>i this is an extended preset command using preset type as first parameter. This is used essentially when we have different types of Presets inside the same system.</p> <p>To get the list of preset types existing in your product use the command: X-PRST-TYPES?</p> <p>This is an Extended Protocol 3000 command.</p>	<p>COMMAND #X-PRST-RESET, preset_type, preset_id<CR></p> <p>FEEDBACK ~nn@X-PRST-RESET, preset_type, preset_id<CR><LF></p>	<ul style="list-style-type: none"> ▪ preset_type – <ul style="list-style-type: none"> ○ System Preset – IOCONFIG.SYSTEM ○ Snapshot – IOCONFIG.SYSTEM.MIXER ▪ preset_id – preset index 	<p>Reset mixer preset 9: X-PRST-RESET, IOCONFIG.SYSTEM.MIXER, 9<CR></p>
X-PRST- SAVED?	<p>Get SAVED status for a preset type. This flag indicates to the WEB if a change have been made since the last RECALL and has not been saved.</p> <p>i this is an extended preset command using preset type as first parameter. This is used essentially when we have different types of Presets inside the same system.</p> <p>To get the list of preset types existing in your product use the command: X-PRST-TYPES?</p> <p>This is an Extended Protocol 3000 command.</p>	<p>COMMAND #X-PRST- SAVED?, preset_type<CR></p> <p>FEEDBACK ~nn@X-PRST- SAVED, preset_type, saved_status<CR><LF></p>	<ul style="list-style-type: none"> ▪ preset_type – <ul style="list-style-type: none"> ○ System Preset – IOCONFIG.SYSTEM ○ Snapshot – IOCONFIG.SYSTEM.MIXER ▪ Saved_status – preset index <ul style="list-style-type: none"> ○ 0 – False (not saved) ○ 1 – True (saved) 	<p>Get saved status of mixer preset: X-PRST- SAVED?, IOCONFIG.SYSTEM.MIXER<CR></p>
X-PRST-STO	<p>Store current changes into a preset (per type).</p> <p>i this is an extended preset command using preset type as first parameter. This is used essentially when we have different types of Presets inside the same system.</p> <p>To get the list of preset types existing in your product use the command: X-PRST-TYPES?</p> <p>This is an Extended Protocol 3000 command.</p>	<p>COMMAND #X-PRST-STO, preset_type, preset_id<CR></p> <p>FEEDBACK ~nn@X-PRST-STO, preset_type, saved_status<CR><LF></p>	<ul style="list-style-type: none"> ▪ preset_type – <ul style="list-style-type: none"> ○ System Preset – IOCONFIG.SYSTEM ○ Snapshot – IOCONFIG.SYSTEM.MIXER ▪ preset_id – preset index 	<p>Store changes into mixer preset 9: X-PRST-STO, IOCONFIG.SYSTEM.MIXER, 9<CR></p>

<p>X-PRST-TYPES?</p>	<p>Get the types of presets that the system supports and their hierarchy.</p>	<p>COMMAND #X-PRST-TYPES?_<CR></p> <p>FEEDBACK ~nn@X-PRST-TYPES_preset_type <CR><LF></p>	<p>▪ preset_type –</p> <ul style="list-style-type: none"> ○ IOCONFIG.SYSTEM – used for system preset per IOConfig, we have 10 preset banks per IOConfig setup, Preset #1 is the default system preset for this setup and is READ ONLY, Preset #2 is used for the first user system preset, Preset #3 for the second etc. ○ IOCONFIG.SYSTEM.MIXER – used for a Mixer snapshot of a specific system preset per IOConfig. There are 10 MIXER snapshots per System presets in each IOConfig setup, Snapshot #1 is the default MIXER snapshot and is READ ONLY. Snapshot #2 is used for the first user Mixer snapshot, Snapshot #3 for the second etc. 	<p>Get preset types: X-PRST-TYPES?_<CR></p>
-----------------------------	---	---	--	---

<p>X-PORT-SELECT</p>	<p>Select ID from selectable ports group.</p> <p>ⓘ User may query group names using command: #X-PORT-SELECT-LIST?.</p> <p>This command is designed to be used by machines and not by users. This command is used for feature auto-discovery mechanism.</p> <p>This is an Extended Protocol 3000 command.</p>	<p>COMMAND #X-PORT-SELECT_group_name,selected_id<CR></p> <p>FEEDBACK ~nn@X-PORT-SELECT_group_name,selected_id,[option_id:[<direction_type>.<port_format>.<port_index>],...,<direction_type>.<port_format>.<port_index>],...,<option_id:[<direction_type>.<port_format>.<port_index>],...,<direction_type>.<port_format>.<port_index>]]<CR><LF></p>	<p>group_name – These are predefined groups names, related to a specific product. (e.g., IN.AUDIO.1 or IN.VIDEO.5)</p> <p>selected_id – Currently selected option ID.</p> <p>option_id – Each option has an ID. Only one option may be selected at the same time. When a specific option is selected, all related port-id members become selected and all port-id members from other, unselected options, become unselected.</p> <p>The following attributes comprise the port ID:</p> <ul style="list-style-type: none"> ▪ <direction_type> – <ul style="list-style-type: none"> ○ Direction of the port: <ul style="list-style-type: none"> ○ IN ○ OUT ○ BOTH ▪ <port_format> – Type of signal on the port: <ul style="list-style-type: none"> ○ HDMI ○ HDBT ○ ANALOG_AUDIO ○ AMPLIFIED_AUDIO ○ TOS ○ SPDIF ○ MIC ○ RS-232 ○ IR ○ USB_A ○ USB_B ▪ <port_index> – The port number as printed on the front or rear panel 	<p>Select ID 2 from selectable ports group: #X-PORT-SELECT_in.audi o.1,2<CR></p>
-----------------------------	--	--	---	---

<p>X-PORT-SELECT?</p>	<p>Get selected ID of selectable ports group.</p> <p>i User may query group names using command: #X-PORT-SELECT-LIST?.</p> <p>This command is designed to be used by machines and not by users. This command is used for feature auto-discovery mechanism.</p> <p>This is an Extended Protocol 3000 command.</p>	<p>COMMAND</p> <pre>#X-PORT-SELECT?_group_name<CR></pre> <p>FEEDBACK</p> <pre>~nn@X-PORT-SELECT_group_name,selected_id,[option_id:[direction_type].<port_format>. <port_index>,...,<direction_type>.<port_format>. <port_index>],...,<option_id:[<direction_type>.<port_format>. <port_index>,...,<direction_type>.<port_format>. <port_index>]]<CR><LF></pre>	<p>group_name – These are predefined groups names, related to a specific product. (e.g., IN.AUDIO.1 or IN.VIDEO.5)</p> <p>selected_id – Currently selected option ID.</p> <p>option_id – Each option has an ID. Only one option may be selected at the same time. When a specific option is selected, all related port-id members become selected and all port-id members from other, unselected options, become unselected. The following attributes comprise the port ID:</p> <ul style="list-style-type: none"> ▪ <direction_type> – Direction of the port: <ul style="list-style-type: none"> ○ IN ○ OUT ○ BOTH ▪ <port_format> – Type of signal on the port: <ul style="list-style-type: none"> ○ HDMI ○ HDBT ○ ANALOG_AUDIO ○ AMPLIFIED_AUDIO ○ TOS ○ SPDIF ○ MIC ○ RS-232 ○ IR ○ USB_A ○ USB_B ▪ <port_index> – The port number as printed on the front or rear panel 	<p>Get the selected ID of port ID "IN.AUDIO.1":</p> <pre>#X-PORT-SELECT?_in.audio.1<CR></pre>
<p>X-PORT-SELECT-LIST?</p>	<p>Get selected id of selectable ports groups of all available groups.</p> <p>i User may query group names using command: #X-PORT-SELECT-LIST?.</p> <p>This is an Extended Protocol 3000 command.</p>	<p>COMMAND</p> <pre>#X-PORT-SELECT-LIST?_<CR></pre> <p>FEEDBACK</p> <pre>~nn@X-PORT-SELECT-LIST?_[[group_name,selected_id,[option_id:[direction_type].<port_format>. <port_index>,...,<direction_type>.<port_format>. <port_index>],...,<option_id:[<direction_type>.<port_format>. <port_index>],...,<direction_type>.<port_format>. <port_index>]]],...,[group_name,selected_id,[option_id:[direction_type].<port_format>. <port_index>],...,<direction_type>.<port_format>. <port_index>],...,<option_id:[<direction_type>.<port_format>. <port_index>],...,<direction_type>.<port_format>. <port_index>]]]]<CR><LF></pre>	<p>The following attributes comprise the port ID:</p> <ul style="list-style-type: none"> ▪ <direction_type> – Direction of the port: <ul style="list-style-type: none"> ○ IN ○ OUT ○ BOTH ▪ <port_format> – Type of signal on the port: <ul style="list-style-type: none"> ○ HDMI ○ HDBT ○ ANALOG_AUDIO ○ AMPLIFIED_AUDIO ○ TOS ○ SPDIF ○ MIC ○ RS-232 ○ IR ○ USB_A ○ USB_B ▪ <port_index> – The port number as printed on the front or rear panel 	<p>Get the selected id of selectable ports groups of all available groups:</p> <pre>#X-PORT-SELECT-LIST<CR></pre>

Result and Error Codes

Syntax

In case of an error, the device responds with an error message. The error message syntax:

- **~NN@ERR XXX<CR><LF>** – when general error, no specific command
- **~NN@CMD ERR XXX<CR><LF>** – for specific command
- **NN** – machine number of device, default = 01
- **XXX** – error code

Error Codes

Error Name	Error Code	Description
P3K_NO_ERROR	0	No error
ERR_PROTOCOL_SYNTAX	1	Protocol syntax
ERR_COMMAND_NOT_AVAILABLE	2	Command not available
ERR_PARAMETER_OUT_OF_RANGE	3	Parameter out of range
ERR_UNAUTHORIZED_ACCESS	4	Unauthorized access
ERR_INTERNAL_FW_ERROR	5	Internal FW error
ERR_BUSY	6	Protocol busy
ERR_WRONG_CRC	7	Wrong CRC
ERR_TIMEDOUT	8	Timeout
ERR_RESERVED	9	(Reserved)
ERR_FW_NOT_ENOUGH_SPACE	10	Not enough space for data (firmware, FPGA...)
ERR_FS_NOT_ENOUGH_SPACE	11	Not enough space – file system
ERR_FS_FILE_NOT_EXISTS	12	File does not exist
ERR_FS_FILE_CANT_CREATED	13	File can't be created
ERR_FS_FILE_CANT_OPEN	14	File can't open
ERR_FEATURE_NOT_SUPPORTED	15	Feature is not supported
ERR_RESERVED_2	16	(Reserved)
ERR_RESERVED_3	17	(Reserved)
ERR_RESERVED_4	18	(Reserved)
ERR_RESERVED_5	19	(Reserved)
ERR_RESERVED_6	20	(Reserved)
ERR_PACKET_CRC	21	Packet CRC error
ERR_PACKET_MISSED	22	Packet number isn't expected (missing packet)
ERR_PACKET_SIZE	23	Packet size is wrong
ERR_RESERVED_7	24	(Reserved)
ERR_RESERVED_8	25	(Reserved)
ERR_RESERVED_9	26	(Reserved)
ERR_RESERVED_10	27	(Reserved)
ERR_RESERVED_11	28	(Reserved)
ERR_RESERVED_12	29	(Reserved)
ERR_EDID_CORRUPTED	30	EDID corrupted
ERR_NON_LISTED	31	Device specific errors
ERR_SAME_CRC	32	File has the same CRC – not changed
ERR_WRONG_MODE	33	Wrong operation mode
ERR_NOT_CONFIGURED	34	Device/chip was not initialized

The warranty obligations of Kramer Electronics Inc. ("Kramer Electronics") for this product are limited to the terms set forth below:

What is Covered

This limited warranty covers defects in materials and workmanship in this product.

What is Not Covered

This limited warranty does not cover any damage, deterioration or malfunction resulting from any alteration, modification, improper or unreasonable use or maintenance, misuse, abuse, accident, neglect, exposure to excess moisture, fire, improper packing and shipping (such claims must be presented to the carrier), lightning, power surges, or other acts of nature. This limited warranty does not cover any damage, deterioration or malfunction resulting from the installation or removal of this product from any installation, any unauthorized tampering with this product, any repairs attempted by anyone unauthorized by Kramer Electronics to make such repairs, or any other cause which does not relate directly to a defect in materials and/or workmanship of this product. This limited warranty does not cover cartons, equipment enclosures, cables or accessories used in conjunction with this product.

Without limiting any other exclusion herein, Kramer Electronics does not warrant that the product covered hereby, including, without limitation, the technology and/or integrated circuit(s) included in the product, will not become obsolete or that such items are or will remain compatible with any other product or technology with which the product may be used.

How Long this Coverage Lasts

The standard limited warranty for Kramer products is seven (7) years from the date of original purchase, with the following exceptions:

1. All Kramer VIA hardware products are covered by a standard three (3) year warranty for the VIA hardware and a standard three (3) year warranty for firmware and software updates; all Kramer VIA accessories, adapters, tags, and dongles are covered by a standard one (1) year warranty.
2. Kramer fiber optic cables, adapter-size fiber optic extenders, pluggable optical modules, active cables, cable retractors, ring mounted adapters, portable power chargers, Kramer speakers, and Kramer touch panels are covered by a standard one (1) year warranty. Kramer 7-inch touch panels purchased on or after April 1st, 2020 are covered by a standard two (2) year warranty.
3. All Kramer Calibre products, all Kramer Minicom digital signage products, all HighSecLabs products, all streaming, and all wireless products are covered by a standard three (3) year warranty.
4. All Sierra Video MultiViewers are covered by a standard five (5) year warranty.
5. Sierra switchers & control panels are covered by a standard seven (7) year warranty (excluding power supplies and fans that are covered for three (3) years).
6. K-Touch software is covered by a standard one (1) year warranty for software updates.
7. All Kramer passive cables are covered by a lifetime warranty.

Who is Covered

Only the original purchaser of this product is covered under this limited warranty. This limited warranty is not transferable to subsequent purchasers or owners of this product.

What Kramer Electronics Will Do

Kramer Electronics will, at its sole option, provide one of the following three remedies to whatever extent it shall deem necessary to satisfy a proper claim under this limited warranty:

1. Elect to repair or facilitate the repair of any defective parts within a reasonable period of time, free of any charge for the necessary parts and labor to complete the repair and restore this product to its proper operating condition. Kramer Electronics will also pay the shipping costs necessary to return this product once the repair is complete.
2. Replace this product with a direct replacement or with a similar product deemed by Kramer Electronics to perform substantially the same function as the original product. If a direct or similar replacement product is supplied, the original product's end warranty date remains unchanged and is transferred to the replacement product.
3. Issue a refund of the original purchase price less depreciation to be determined based on the age of the product at the time remedy is sought under this limited warranty.

What Kramer Electronics Will Not Do Under This Limited Warranty

If this product is returned to Kramer Electronics or the authorized dealer from which it was purchased or any other party authorized to repair Kramer Electronics products, this product must be insured during shipment, with the insurance and shipping charges prepaid by you. If this product is returned uninsured, you assume all risks of loss or damage during shipment. Kramer Electronics will not be responsible for any costs related to the removal or re-installation of this product from or into any installation. Kramer Electronics will not be responsible for any costs related to any setting up this product, any adjustment of user controls or any programming required for a specific installation of this product.

How to Obtain a Remedy Under This Limited Warranty

To obtain a remedy under this limited warranty, you must contact either the authorized Kramer Electronics reseller from whom you purchased this product or the Kramer Electronics office nearest you. For a list of authorized Kramer Electronics resellers and/or Kramer Electronics authorized service providers, visit our web site at www.kramerav.com or contact the Kramer Electronics office nearest you.

In order to pursue any remedy under this limited warranty, you must possess an original, dated receipt as proof of purchase from an authorized Kramer Electronics reseller. If this product is returned under this limited warranty, a return authorization number, obtained from Kramer Electronics, will be required (RMA number).

You may also be directed to an authorized reseller or a person authorized by Kramer Electronics to repair the product.

If it is decided that this product should be returned directly to Kramer Electronics, this product should be properly packed, preferably in the original carton, for shipping. Cartons not bearing a return authorization number will be refused.

Limitation of Liability

THE MAXIMUM LIABILITY OF KRAMER ELECTRONICS UNDER THIS LIMITED WARRANTY SHALL NOT EXCEED THE ACTUAL PURCHASE PRICE PAID FOR THE PRODUCT. TO THE MAXIMUM EXTENT PERMITTED BY LAW, KRAMER ELECTRONICS IS NOT RESPONSIBLE FOR DIRECT, SPECIAL, INCIDENTAL OR CONSEQUENTIAL DAMAGES RESULTING FROM ANY BREACH OF WARRANTY OR CONDITION, OR UNDER ANY OTHER LEGAL THEORY. Some countries, districts or states do not allow the exclusion or limitation of relief, special, incidental, consequential or indirect damages, or the limitation of liability to specified amounts, so the above limitations or exclusions may not apply to you.

Exclusive Remedy

TO THE MAXIMUM EXTENT PERMITTED BY LAW, THIS LIMITED WARRANTY AND THE REMEDIES SET FORTH ABOVE ARE EXCLUSIVE AND IN LIEU OF ALL OTHER WARRANTIES, REMEDIES AND CONDITIONS, WHETHER ORAL OR WRITTEN, EXPRESS OR IMPLIED. TO THE MAXIMUM EXTENT PERMITTED BY LAW, KRAMER ELECTRONICS SPECIFICALLY DISCLAIMS ANY AND ALL IMPLIED WARRANTIES, INCLUDING, WITHOUT LIMITATION, WARRANTIES OF MERCHANTABILITY AND FITNESS FOR A PARTICULAR PURPOSE. IF KRAMER ELECTRONICS CANNOT LAWFULLY DISCLAIM OR EXCLUDE IMPLIED WARRANTIES UNDER APPLICABLE LAW, THEN ALL IMPLIED WARRANTIES COVERING THIS PRODUCT, INCLUDING WARRANTIES OF MERCHANTABILITY AND FITNESS FOR A PARTICULAR PURPOSE, SHALL APPLY TO THIS PRODUCT AS PROVIDED UNDER APPLICABLE LAW. IF ANY PRODUCT TO WHICH THIS LIMITED WARRANTY APPLIES IS A "CONSUMER PRODUCT" UNDER THE MAGNUSON-MOSS WARRANTY ACT (15 U.S.C.A. §2301, ET SEQ.) OR OTHER APPLICABLE LAW, THE FOREGOING DISCLAIMER OF IMPLIED WARRANTIES SHALL NOT APPLY TO YOU, AND ALL IMPLIED WARRANTIES ON THIS PRODUCT, INCLUDING WARRANTIES OF MERCHANTABILITY AND FITNESS FOR THE PARTICULAR PURPOSE, SHALL APPLY AS PROVIDED UNDER APPLICABLE LAW.

Other Conditions

This limited warranty gives you specific legal rights, and you may have other rights which vary from country to country or state to state.

This limited warranty is void if (i) the label bearing the serial number of this product has been removed or defaced, (ii) the product is not distributed by Kramer Electronics or (iii) this product is not purchased from an authorized Kramer Electronics reseller. If you are unsure whether a reseller is an authorized Kramer Electronics reseller, visit our web site at www.kramerav.com or contact a Kramer Electronics office from the list at the end of this document.

Your rights under this limited warranty are not diminished if you do not complete and return the product registration form or complete and submit the online product registration form. Kramer Electronics thanks you for purchasing a Kramer Electronics product. We hope it will give you years of satisfaction.



HDMI™
HIGH-DEFINITION MULTIMEDIA INTERFACE

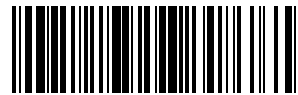

P/N: 2900-301565



Rev: 4



SAFETY WARNING

Disconnect the unit from the power supply before opening and servicing

For the latest information on our products and a list of Kramer distributors, visit our website where updates to this user manual may be found.

We welcome your questions, comments, and feedback.

The terms HDMI, HDMI High-Definition Multimedia Interface, and the HDMI Logo are trademarks or registered trademarks of HDMI Licensing Administrator, Inc. All brand names, product names, and trademarks are the property of their respective owners.