

KB-300 V2
Keyboard Quick Start Guide

Version 1.1.2

Table of Contents

1	Features and Specifications	1
1.1	Features	1
1.2	Front Panel	1
1.3	Rear Panel	3
1.3.1	Network Keyboard Series	3
1.4	Port Features.....	4
1.5	Power.....	4
2	Menu Operation.....	5
2.1	Boot up and Shut down	5
2.1.1	Boot up.....	5
2.1.2	Shut Down	5
2.2	Main Menu List.....	5
2.3	Menu Operation	7
2.3.1	System	7
2.3.2	Zone (Control Point).....	9
2.3.3	Account	10
2.3.4	Config.....	11
2.3.5	Version.....	12
2.4	Zones.....	12
3	Keyboard Control Speed Dome	13
3.1	Cable Connection	13
3.2	Keyboard Setup	13
3.3	Operation	13
3.3.1	Speed Dome Menu	13
3.3.2	Iris/Zoom/Focus.....	14
3.3.3	Preset.....	14
3.3.4	Scan	14
3.3.5	Pan	15
3.3.6	Tour	15
3.3.7	Pattern.....	16
4	Keyboard Control DVR.....	18
4.1	Keyboard Setup	18
4.1.1	COM Connection.....	18
4.1.2	Network Connection Setup	18
4.2	Operation	18
4.2.1	Login.....	18
4.2.2	Logout	19
4.2.3	General Function.....	19
4.2.4	Playback	19
5	Network Keyboard to Control Decoder.....	21
5.1	Splicing Screen Control	21
5.2	Output Video to the TV wall	22
5.3	Zone Settings via the Keyboard	23
6	Network Keyboard to Control Analog Matrix	24

6.1	Analog Matrix Operation.....	24
6.2	Keyboard Operation	24
7	Network Keyboard to Control Video Matrix Platform.....	25
7.1	Splicing Screen Control	25
7.2	Output Video to the Wall.....	25
7.3	Zone Settings via the Keyboard	27
8	Make COM Cable.....	28
8.1	Make RS232 COM Cable.....	28
8.2	Make RS485 COM Cable.....	28
8.3	25-pin Port and Switch Box Connection	29
8.4	RJ45 Network Port Connection	29

Welcome

- Thank you for purchasing our keyboard!
- This quick start guide is designed to be a reference tool for the operation of your system.
- Before the operation please read the following safeguards and warnings carefully!
- Please keep it well for future reference.

Regulatory Information

FCC Information



Changes or modifications not expressly approved by the party responsible for compliance could void the user's authority to operate the equipment.

FCC conditions:

This device complies with part 15 of the FCC Rules. Operation is subject to the following two conditions:

- This device may not cause harmful interference.
- This device must accept any interference received, including interference that may cause undesired operation.

FCC compliance:

This equipment has been tested and found to comply with the limits for a digital device, pursuant to part 15 of the FCC Rules. This equipment generate, uses and can radiate radio frequency energy and, if not installed and used in accordance with the guide, may cause harmful interference to radio communication.

- For class A device, these limits are designed to provide reasonable protection against harmful interference in a commercial environment. Operation of this equipment in a residential area is likely to cause harmful interference in which case the user will be required to correct the interference at his own expense.
- For class B device, these limits are designed to provide reasonable protection against harmful interference in a residential installation. However, there is no guarantee that interference will not occur in a particular installation. If this equipment does cause harmful interference to radio or television reception, which can be determined by turning the equipment off and on, the user is encouraged to try to correct the interference by one or more of the following measures:
 - Reorient or relocate the receiving antenna.
 - Increase the separation between the equipment and receiver.
 - Connect the equipment into an outlet on a circuit different from that to which the receiver is connected.
 - Consult the dealer or an experienced radio/TV technician for help.

Important Safeguarding and Warnings

1. Electrical safety

All installation and operation here should conform to your local electrical safety codes.

The product must be grounded to reduce the risk of electric shock.

This unit is to be connected only to the devices whose power feeding meets the requirements for SELV (Safety Extra Low Voltage) and complies with Limited Power Source according to IEC60950-1.).

We assume no liability or responsibility for all the fires or electrical shock caused by improper handling or installation.

2. Transportation security

Heavy stress, violent vibration or water splash are not allowed during transportation, storage and installation.

3. Installation

Keep upwards. Handle with care.

Do not place objects on the network keyboard.

4. Qualified engineers needed

All the examination and repair work should be done by the qualified service engineers.

We are not liable for any problems caused by unauthorized modifications or attempted repair.

5. Environment

The keyboard should be used in a cool, dry place away from direct sunlight, inflammable, explosive substances and etc.

6. Accessories

Be sure to use all the accessories recommended by manufacturer.

Before installation, please open the package and check all the components are included.

Contact your local retailer ASAP if something is missing in your package.



CAUTION

FOR YOUR SYSTEM SAFETY, PLEASE CHANGE THE DEFAULT PASSWORD AFTER YOU FIRST LOGIN!

RISK OF EXPLOSION IF BATTERY IS REPLACED BY AN INCORRECT TYPE.

DISPOSE OF USED BATTERIES ACCORDING TO THE INSTRUCTIONS.

Privacy Protection Notice

As the device user or data controller, you might collect personal data of others, such as face, fingerprints, car plate number, Email address, phone number, GPS and so on. You need to be in compliance with the local privacy protection laws and regulations to protect the legitimate rights and interests of other people by implementing measures, including but not limited to: providing clear and visible identification to inform data subject the existence of surveillance area and providing related contact.

About the Manual

- The Manual is for reference only. If there is inconsistency between the Manual and the actual product, the actual product shall prevail.
- We are not liable for any loss caused by the operations that do not comply with the Manual.
- The Manual would be updated according to the latest laws and regulations of related regions. For detailed information, see the paper User's Manual, CD-ROM, QR code or our official website. If there is inconsistency between paper User's Manual and the electronic version, the electronic version shall prevail.
- All the designs and software are subject to change without prior written notice. The product updates might cause some differences between the actual product and the Manual. Please contact the customer service for the latest program and supplementary documentation.
- There still might be deviation in technical data, functions and operations description, or errors in print. If there is any doubt or dispute, please refer to our final explanation.
- Upgrade the reader software or try other mainstream reader software if the Guide (in PDF format) cannot be opened.
- All trademarks, registered trademarks and the company names in the Manual are the properties of their respective owners.
- Please visit our website, contact the supplier or customer service if there is any problem occurred when using the device.
- If there is any uncertainty or controversy, please refer to our final explanation.

1 Features and Specifications

1.1 Features

This series keyboard has the following features

- One keyboard can control multiple DVRs, or you can use multiple keyboards to control one DVR.
- Support PTZ camera (speed dome) operation.
- Support RS485 port and RS232 port.
- Support PTZ operation via joystick.
- Support all operations you get from DVR front panel function keys.
- Support keyboard lock function.
- Support multiple-level operation rights.
- Support cascade connection.
- Support single or multiple DVRs's menu setup.
- On-screen menu, user-friendly procedure. It is very easy for you to operate.

Besides above mentioned features, network keyboard also has the following features:

- Can control network video server and network video decoder.
- Support network port connection.

1.2 Front Panel

The keyboard front panel is shown as below. See Figure 1-1.



Figure 1-1

Please refer to the following sheet for detailed information.

SN	Note	Icon	Button Name	Function
1	General function panel	ESC	ESC	<ul style="list-style-type: none"> ● Cancel/return. Delete the previous space of the buffer input contents. ● In playback mode, click this key to go back to realtime surveillance mode.
		SETUP	Switch mode	Switch between PTZ/decoder control interface.

SN	Note	Icon	Button Name	Function
				<ul style="list-style-type: none"> ● 【Setup】 :Set use mode switch ● 1+ 【Setup】 :Main stream sub stream mode switch.
		SHIFT	Change input method	<ul style="list-style-type: none"> ● Switch between input methods ● Go to the previous video channel.
		ENTER	Confirm button	<ul style="list-style-type: none"> ● On DVR main menu, confirm current operation ● Go to the next video channel.
		0~9	Character and numerals	Switch between numeral/characters, click 【SHIFT】 to switch.
2	DVR control panel	ID	ID shortcut	Shortcut key to go to ID zone search, After successful zone connection, click the 【ID】 to disconnect the device.
		CAM	Device channel number	Control DVR channel. <ul style="list-style-type: none"> ● 0+ 【CAM】 : Close the video source of current window. ● 1+ 【CAM】 : Output the video source No.1 to the TV wall.
		MULT	Split button	<ul style="list-style-type: none"> ● Control DVR window split ● 4+ 【MULT】 : Split current window to 4-split.
		AUX	Auxiliary	<ul style="list-style-type: none"> ● User aux record ● Open DVR local PTZ interface.
		FN	Function key	Work with the number buttons. <ul style="list-style-type: none"> ● 【FN+1】 : Go to DVR assistant interface. ● 【FN+2】 : Tour ● 【FN+3】 : Electronic zoom
		PTZ	Window PTZ button	<ul style="list-style-type: none"> ● Control channel PTZ. ● Select specified window. 1+ 【PTZ】 :Select the first window of current screen.
		PLAY	Screen Playback button	<ul style="list-style-type: none"> ● Control DVR playback ● Select the specified screen of the TV wall. 1+ 【PLAY】 : Select the No.1 output screen.
3	Speed dome control panel	IRIS	Iris	Control iris.
		FOCUS	Focus	Control focus
		ZOOM	Zoom	Control zoom.
		OTHER	Speed dome menu	<ul style="list-style-type: none"> ● Set mode: Go to speed dome menu. ● Use mode: Clear buffer.
		PERSET	Preset	<ul style="list-style-type: none"> ● Set mode: For example, 11+ 【PRESET】 is to set preset No.11. ● Use mode: For example, 11+ 【PRESET】 is to call preset No.11.
		SCAN	Scan	<ul style="list-style-type: none"> ● Set mode: Click 【SCAN】 to go to setup interface. ● Use mode: For example, 5+ 【SCAN】 is to call scan No.5 and then click 【SCAN】 to stop.
		PAN	Pan	<ul style="list-style-type: none"> ● Start pan ● Stop pan
		TOUR	Tour	<ul style="list-style-type: none"> ● Set mode: Click 【TOUR】 is to go to tour interface. ● Use mode: For example, 5+ 【TOUR】 is to call tour No.5 and then click the 【TOUR】

SN	Note	Icon	Button Name	Function
				to stop.
		PATTERN	Pattern	<ul style="list-style-type: none"> ● Set mode: Click 【PATTERN】 is to go to setup interface. ● Use mode: For example, 5+ 【PATTERN】 is to call pattern No.5 and then click the 【PATTERN】 to stop.
4	3D Joystick	-	-	Aux menu and function operation.
5	Indicator light panel	PWR	Power indicator light	The light is on when the keyboard is properly connected to the power supplying.
		TR/TX	Network data receive and send indicator light	The light is flashing when the keyboard is connected to the network.
		NET	Network indicator light	The light is on when the device is connected to the network.
		232	RS232 indicator light	The light is flashing when there is 232 data transmission.
		485	RS485 indicator light	The light is flashing when there is 485 data transmission.
		USB	USB indicator light	The light is on when the keyboard is connected to the USB device. <ul style="list-style-type: none"> ● For network keyboard, the light is on when the keyboard is connected to the PC. ● For analog keyboard and speed dome keyboard, the light is on when the keyboard is connected to the USB device.
6	LCD	-	-	OSD menu

1.3 Rear Panel

1.3.1 Network Keyboard Series

Please refer to Figure 1-2 for network keyboard port information.

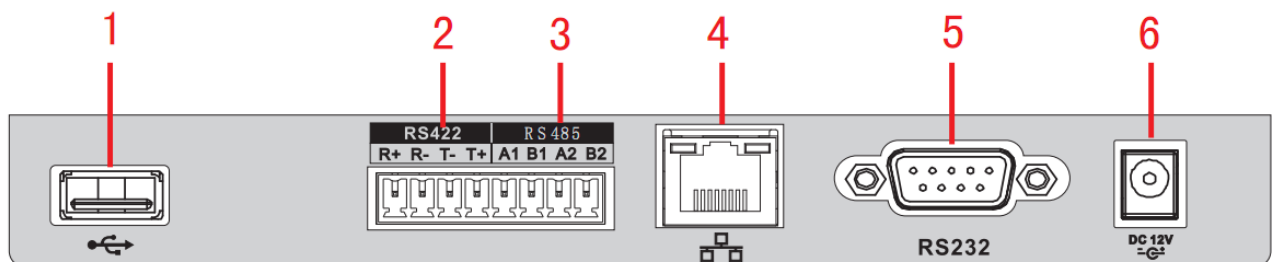

Figure 1-2

Please refer to the following sheet for detailed information.

SN	Port Name	SN	Port Name	SN	Port Name
1	USB port	2	RS422 port	3	RS485 port
4	Network port	5	RS232 port	6	Power socket

1.4 Port Features

- RS232 port can directly connect to device if there is RS232 port. The distance should be within 10m.
- RS485 transmission distance is 1200 m (9600bps) , max 3000m actually.
- For network keyboard series, please connect to the network port to connect the DVR or the network speed dome.

1.5 Power

The keyboard uses DC12V 2A, you can use the adapter included in the accessories bag.

2 Menu Operation

2.1 Boot up and Shut down

2.1.1 Boot up

- 1) Connect the keyboard to the proper power supplying source. The power indicator light is on. You can see the welcome interface (support customized setup) after the device properly booted up.
- 2) Click **【ENTER】** or **【SETUP】** button to go to the following interface. See Figure 2-1.

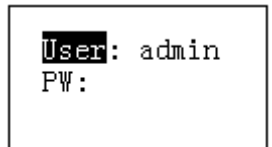

Figure 2-1

- 3) Use joystick to control the up/down/left/right to Input user name and password, system goes to the main menu.

Note

- Factory default user names are: **admin/default/guest**. **By default it does not come with a password.**
- **You will need to set a password when first deploying the device.** Input an **8-character, alphanumeric password** under the **Password field** and input the same password under the **OK field**.
- The **default** can not add/delete user, modify user rights or manage rights.
- The **guest** can only operate control points. There are no other rights.

2.1.2 Shut Down

After you exit the system, unplug the power cable to turn off the device.

2.2 Main Menu List

The menu may vary due to different products. The following figure is based on the network keyboard.

The main menu list is shown as below. See Figure 2-2.

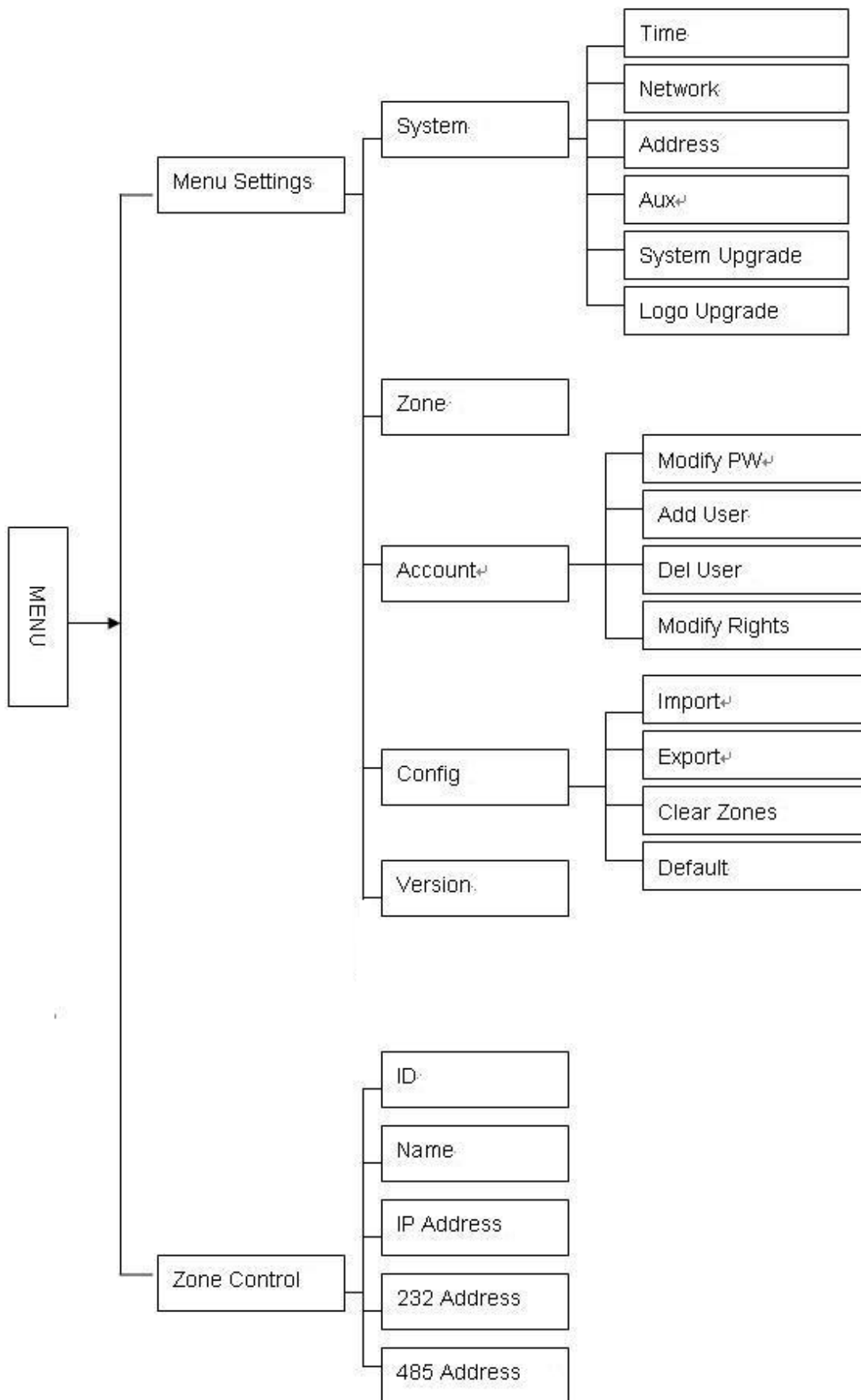

Figure 2-2

2.3 Menu Operation

Use the joystick on keyboard to move up/down/left/right to select items.

Use keyboard to input number or character to set parameters.

Click **【ENTER】** to confirm current operation. Click **【ESC】** to exit.

2.3.1 System

The system manager includes time setup, network setup, address setup, aux setup, system update and logo update. See Figure 2-3.

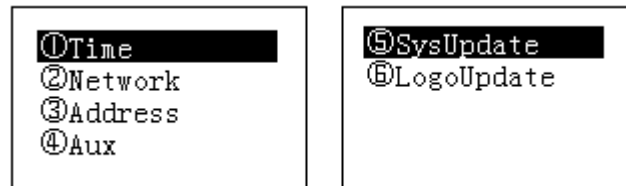

Figure 2-3

2.3.1.1 Time

It is to set keyboard system time. It includes year, month, date, minute and second. See Figure 2-4.

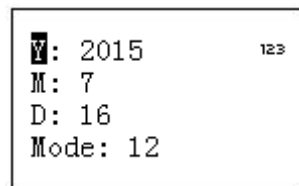

Figure 2-4

2.3.1.2 Network

- When DHCP is enabled, the keyboard can auto get the IP address, subnet mask, gateway, port and etc.
- When DHCP is disabled, you can manually input keyboard IP address, subnet mask, gateway, port(Default setup is 37777) and etc. Please set according to your actual situation. See Figure 2-5.

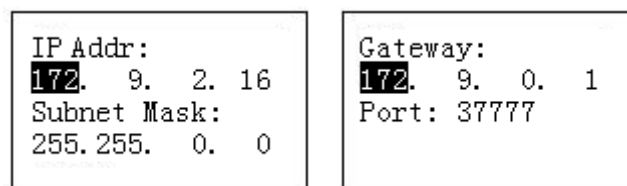

Figure 2-5

2.3.1.3 Address

The address value ranges from 0 to 255. The default setup is 0. When there is cascade connection, the 0 has the highest priority and the 255 has the lowest priority. See Figure 2-6.

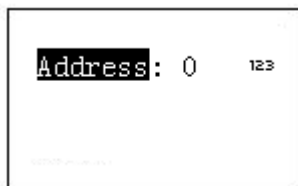

Figure 2-6

2.3.1.4 Aux

It is to set screen backlight and auto logout function. See Figure 2-7.

- Backlight: It is to set screen backlight. The options are: on/off.
- Auto logout: After you enable the auto logout function, system can auto logout when there is no operation for specified time.

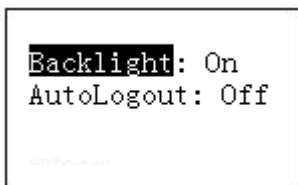

Figure 2-7

2.3.1.5 System Update



Do not remove the flash disk during the whole process. Otherwise it may result in upgrade failure and the network keyboard can not boot up properly.

- The flash disk upgrade function is for speed dome keyboard or analog keyboard series product. You can use the **update.bin** file on the USB device to upgrade. Please select system update interface and click **【ENTER】** button to go to the update interface. Follow the prompt to click the **【ENTER】** to update.
- For network keyboard, you can use the Windows upgrade tool. Please contact your local retailer or visit our official website to get the Windows upgrade tool. The REC Upgrade or REC Upgrade are both OK. If the ConfigTool can not search the keyboard, please upgrade manually. Now we use REC Upgrade for an example. The interface is shown as below. See Figure 2-8.

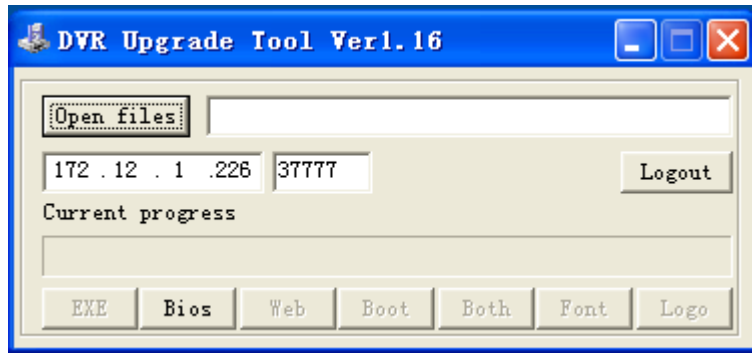

Figure 2-8

- 1) Open **REC Upgrade**, input keyboard IP address and TCP port (Default setup is 37777).

Note

If you can not use the 37777 to upgrade, it means the application layer did not boot up properly. Please use port 3800 to upgrade. The upgrade process can become successful no matter the application layer properly booted up or not.

- 2) Click **login**, system pops up the dialogue box,.
- 3) Input admin user name and password, click **OK**. The **login** button becomes **logout** if you successfully logged in.
- 4) Click **Open files** button to select the upgrade file.
- 5) Click the button **Bios** at the bottom of the interface, you can complete the upgrade process.

2.3.1.6 Logo update

The logo upgrade function is for speed dome keyboard or analog keyboard series product. You can update **logo.bin** file if necessary.

2.3.2 Zone (Control Point)

It is to set control point information. See Figure 2-9. All the items listed below shall be set. You can use the ID, device name, COM address or the IP address to search a device easily in chapter 2.4.

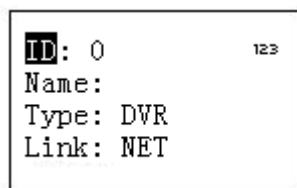

Figure 2-9



- The information you input here shall be unique. Otherwise, system can not save the setup.
- Please make sure the com type and then parameters you set here is the same as the actual situations. Otherwise, the keyboard can not control the device!

- ID: It is device ID number so that you can recognize device quickly.
- Name: Customized device name.
- Type: Device type. The options include: SD/NVD/DVR/DVM/MATRIX.
- Link: The options include: NET/RS232/RS485. Please select the type and set the corresponding parameters. The interface is shown as in Figure 2-10.

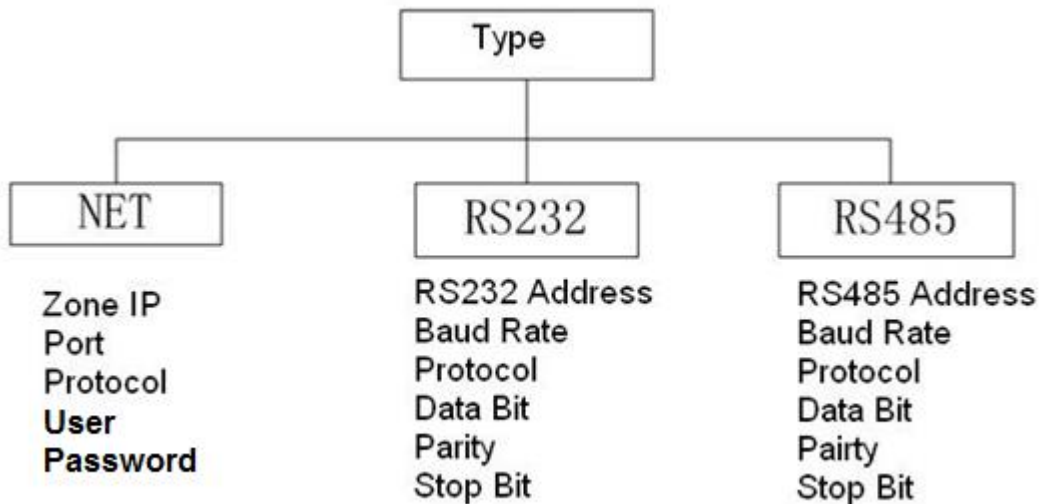

Figure 2-10

When your link mode is net, please input corresponding administrator password to login. Please go to the controlled device to set the user name and password. The DVR and NVR have the rights management to realize password verification.

2.3.3 Account

Here is for you to change password, add user, and delete user and its rights. See Figure 2-11.

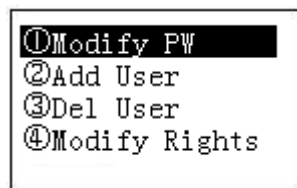

Figure 2-11

2.3.3.1 Change password

Select a user and then input new password. Usually we recommend 6-digit password and you can change the input method to input password value. Input password again to confirm. You can see the corresponding dialogue box if your two passwords input here are not the same. Please click **【ESC】** to return to modify and click **【ENTER】** button to save. See Figure 2-12.

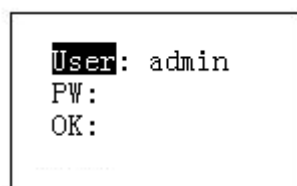

Figure 2-12

2.3.3.2 Add Users

Please input user name (max 8-digit) and then set corresponding password. The group options include user/guest. See Figure 2-13,

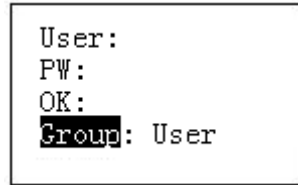

Figure 2-13

- Guest: The guest can only operate control point operation.
- User: The user has the PTZ control, system setup, backup, advanced setup and etc. Move the cursor to the corresponding item and then use the joystick to move the left/right to turn ○ to ● to enable this function. See Figure 2-14.

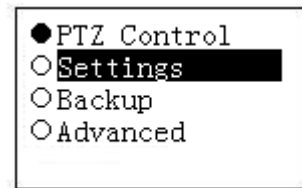

Figure 2-14

Note

Please go to the controlled device to set rights.

2.3.3.3 Delete Users

Select a user first and then click **【ENTER】** to remove.

2.3.3.4 Rights

It is to change user rights.

2.3.4 Config

Note

The configuration files import/export function is for speed dome keyboard and analog keyboard series product only.

The configuration manager includes configuration files import/export, clear zones and factory default setup. See Figure 2-15.

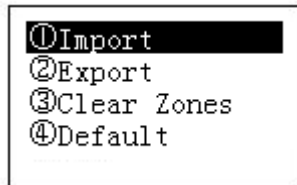

Figure 2-15

2.3.4.1 Import

Insert the flash disk that contains the upgrade files to the keyboard and then go to the import interface. Click **【ENTER】** to import the configuration files.

2.3.4.2 Export

Insert the flash disk to the keyboard and then go to the export interface. Click **【ENTER】** to export the configuration files.

2.3.4.3 Clear Zones

Go to the clear zones interface and then click **【ENTER】** to clear all control points.

2.3.4.4 Default

Go to the default interface and then click **【ENTER】** to restore keyboard configuration to factory default setup.

2.3.5 Version

It is for you to view current version information and etc. See Figure 2-16.

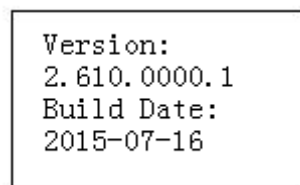

Figure 2-16

2.4 Zones

In this interface, you can quickly search a device via device ID, device name, COM address, IP and etc. See Figure 2-17.

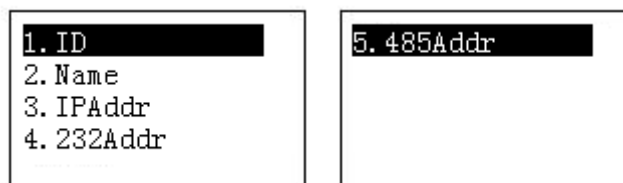

Figure 2-17

3 Keyboard Control Speed Dome

3.1 Cable Connection

Please connect keyboard A/B line to speed dome A/B line connection.

3.2 Keyboard Setup

- Please make sure keyboard A/B line and speed dome A/B line connection is right.
- Set speed dome address so that the speed dome address and the keyboard RS485 address are the same.
- Go to the zones interface of the keyboard and then select the type as SD. Please refer to chapter 2.3.2.

Note

- Please select protocol according to the speed dome type. The default setup is DH-SD (There are some other popular protocols such as PELCOD, PELCOP). The step is 8.
 - Please login WEB of the speed dome, from main interface->Setup->System->PTZ to view speed dome address, protocol, COM setup and etc.
- After the setup, click **【ESC】** to exit control point control interface. System pops up a dialogue box you can click **【ENTER】** to save data or click **【ESC】** to cancel setup.

3.3 Operation

On the keyboard, click **【ID】** to go to the control point interface to set speed dome ID to connect to the speed dome.

After successful connection, the interface is shown as below. See Figure 3-1.

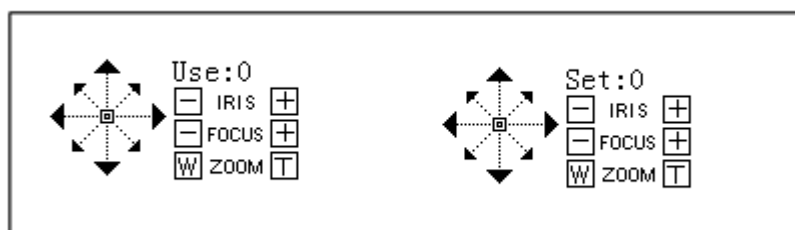

Figure 3-1

- Step: The speed dome adopts variable step mode by default. The speed dome movement becomes faster along with the angle of the joystick becomes larger.
- The lens movement supports 8 directions. It includes: up/down/left/right/top left/top right/bottom left/bottom right. Please use the joystick to control.

3.3.1 Speed Dome Menu

- Set mode: Click **【Menu】** button to go to the speed dome menu setup interface.
- Use joystick up/down or the Iris \pm to control the selected menu item up/down.
- Use joystick left/right or the focus \pm to control the selected menu contents.
- Click **【ENTER】** to go to the next-level menu, click **【ESC】** to exit the menu. Move to select the Back and then click **【ENTER】**, you can go back to the previous level.

- On the speed dome, click **【ESC】** to go back to PTZ control interface.

3.3.2 Iris/Zoom/Focus

3.3.2.1 Iris

On the keyboard, click **【IRIS】** button, use button **【+】** and **【-】** or turn joystick up/down to control the iris.

3.3.2.2 Focus

On the keyboard click **【FOCUS】** button, use button **【+】** and **【-】** or turn joystick left/right to control the focus.

3.3.2.3 Zoom

On the keyboard click **【ZOOM】** button, use button **【+】** and **【-】** or turn joystick clockwise or counter clockwise to control the zoom.

3.3.3 Preset

Shortcut Mode

- On the Set mode, use keyboard to input **【No.】** + **【Preset】** , you can set a preset quickly.
- On the Use mode, use keyboard to input **【No.】** + **【Preset】** , you can set a preset quickly.

General Mode

On the keyboard click **【PRESET】** , the interface is shown as below. See Figure 3-2.

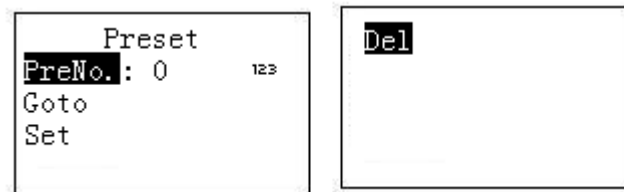

Figure 3-2

3.3.3.1 Set Preset

Input preset number and then select **【Set】** , click **【ENTER】** to save preset setup.

3.3.3.2 Go to preset

Input preset number and then select **【Goto】** , click **【ENTER】** to go to the corresponding preset position.

3.3.3.3 Delete preset

Input the preset number and then select **【Del】** , click **【ENTER】** to remove it.

3.3.4 Scan

Shortcut Mode

On the Use mode, use keyboard to input **【No.】** + **【Scan】** , you can call a scan. Click **【Scan】** to stop it.

General Mode

On Set mode, click **【SCAN】** button, the interface is shown as below. See Figure 3-3.



Figure 3-3

Please follow the steps listed below.

a) Select Set and then click **【ENTER】**, you can see an interface shown as in Figure 3-4.

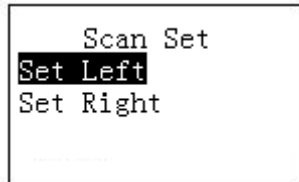

Figure 3-4

b) Use 3D joystick to select left limit and right limit.

c) Click **【ENTER】** to complete setup.

- Select start and then click **【ENTER】**, system begins to scan according to the left/right limit you set.
- Select stop and then click **【ENTER】**, system stops scan.

3.3.5 Pan

Shortcut Mode

On the Use mode, click **【Pan】** button on the keyboard, the speed dome begins pan. Click **【Pan】** again to stop it.

General Mode

On Set mode, click **【PAN】** button on the keyboard, the interface is shown as below. See Figure 3-5.

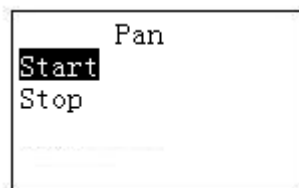

Figure 3-5

- Select start and then click **【ENTER】** button, system begins pan operation.
- Select stop and then click **【ENTER】** button, system stops pan operation.

3.3.6 Tour

Shortcut Mode

On the Set mode, use keyboard to input **【No.】 + 【Tour】**, you can call a tour. Click **【Tour】** again to stop it.

General Mode

On Set mode, click **【TOUR】** button on the keyboard, the interface is shown as below. See Figure 3-6.



Figure 3-6

3.3.6.1 Set tour

a) Select Set item, the interface is shown as in Figure 2-10.

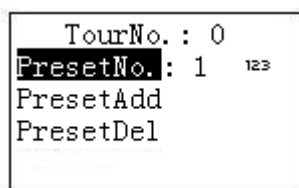

Figure 3-7

b) Input a value at the tour No.

c) Add/Delete preset to/from the tour.

- Input preset No. and then select PresetAdd, click **【ENTER】** button to add the input preset to the tour.
- Input preset No. and then select PresetDel, click **【ENTER】** button to delete the input preset from the tour.

Note

You can add several presets to add to a tour.

3.3.6.2 Call tour

- Select Start and then click **【ENTER】**, speed dome begins tour.
- Select Stop and then click **【ENTER】**, speed dome stops tour.
- Select Delete and then click **【ENTER】**, speed dome removes the tour.

3.3.7 Pattern

Shortcut Mode

On the Use mode, use keyboard to input **【No.】** + **【Pattern】**, you can call a pattern. Click **【Pattern】** again to stop it.

General Mode

On Set mode, click **【PATTERN】** on the keyboard, the interface is shown as below. See Figure 3-8.

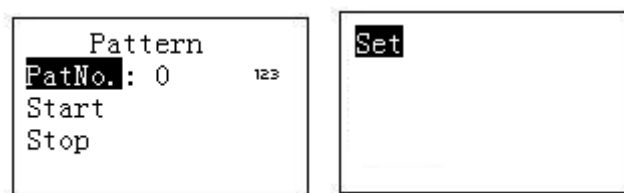

Figure 3-8

3.3.7.1 Set pattern

- a) Select tour number and then input a value.
- b) Select tour set button and then click **【ENTER】** button.
- c) Use joystick to set pattern and then click **【ENTER】** to end. The speed dome can memorize your whole operation.

3.3.7.2 Start pattern

Select pattern No. and then input a pattern number, select start and then click **【ENTER】** button, system begins pattern operation.

3.3.7.3 Stop pattern

Select pattern No. and then input a pattern number, select stop and then click **【ENTER】** button, system stops pattern operation.

4 Keyboard Control DVR

4.1 Keyboard Setup

4.1.1 COM Connection

Note

Please refer to chapter 8 to make COM cable.

- a) Before operation, please make sure cable connection is proper.
- b) In DVR menu, from Setting->System->RS232. The COM function is network keyboard and then set corresponding parameters.

The default setup is shown as below.

- Baud rate: 9600
- Data bit: 8
- Stop bit: 1
- Parity: none.

Please note keyboard setup should conform to DVR setup.

- c) Go to the zones interface of the keyboard. Please refer to chapter 2.3.2

Note

- RS232 address/RS485 address is the device No. of the DVR.
 - The protocol usually is DH-2. It is the network keyboard and the 2nd control keyboard protocol. The DVR COM protocol is network keyboard protocol.
- d) After the setup, click **【ESC】** to exit control point control interface. System pops up a dialogue box you can click **【ENTER】** to save data or click **【ESC】** to cancel setup.

4.1.2 Network Connection Setup

The network connection steps are similar to the COM setup. Please note, on the zones interface, the link type shall be NET.

Please input DVR IP address, the control point port is 37777. The protocol is the same as the COM setup. Please refer to chapter 2.3.2 control point for detailed information.

4.2 Operation

4.2.1 Login



The DVR local user has the higher priority than the keyboard user. Before you login, please logout the DVR local menu user, otherwise, you can not use the keyboard to control the device.

You can select ID, device name, IP address, RS232, RS485 and etc to login.

- a) Click **【ENTER】** on the keyboard, you can go to the menu options interface.
- b) Select zones.

- c) Input ID, device name, IP address.RS232, RS485 you set on control point interface, Click **【ENTER】** to begin search.

System auto connect to the DVR after successfully search operation.

Tips

Click **【ID】** on the keyboard and then input ID number. Click **【ENTER】** to quickly find the device.

4.2.2 Logout

Click **【ID】** on the keyboard and then click **【ESC】** to exit current menu.

4.2.3 General Function

4.2.3.1 Press one by one

- **【No.】 + 【Split】** : It is to Control split.
For example, input 16 and then click split button, you can realize 16-split function on the DVR.
If you use the joystick now:
 - **【Left/right】** : switch between 1~16/17~32.
 - **【Up/down】** : DVR split in 1/4/9 or 25/32.
- **【No.】 + 【CAM】** :Select corresponding channel.
Input 9 and then click CAM button, the DVR displays the video from channel 9.
- **【No.】 + 【PTZ】** : Control the PTZ of the corresponding digital channel.

4.2.3.2 Press at the same time

- **【AUX+1】** : Record
- **【AUX+2】** : Open DVR PTZ control, click FN+1 to switch page.
- **【FN+1】** : Aux function.
- **【FN+2】** : Tour (The macro of the DVR shall be enabled.)
- **【FN+3】** : Control electronic zoom.

4.2.4 Playback

Click **【PLAY】** on the keyboard, you can go to the DVR search interface. Use joystick to control the playback buttons such as stop, fast play, slow play and etc. Click **【ENTER】** to confirm. See Figure 4-1.

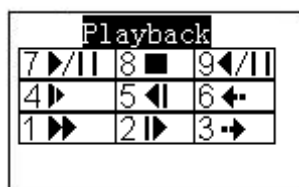

Figure 4-1

SN	Function	SN	Function	SN	Function
7	Play	8	Stop	9	Playback
4	Slow play	5	Play backward frame by frame	6	Previous record
1	Fast play	2	Play frame	3	Next record

SN	Function	SN	Function	SN	Function
			by frame		

5 Network Keyboard to Control Decoder

5.1 Splicing Screen Control

Login the Web of the decoder, you can see the following interface. See Figure 5-1.

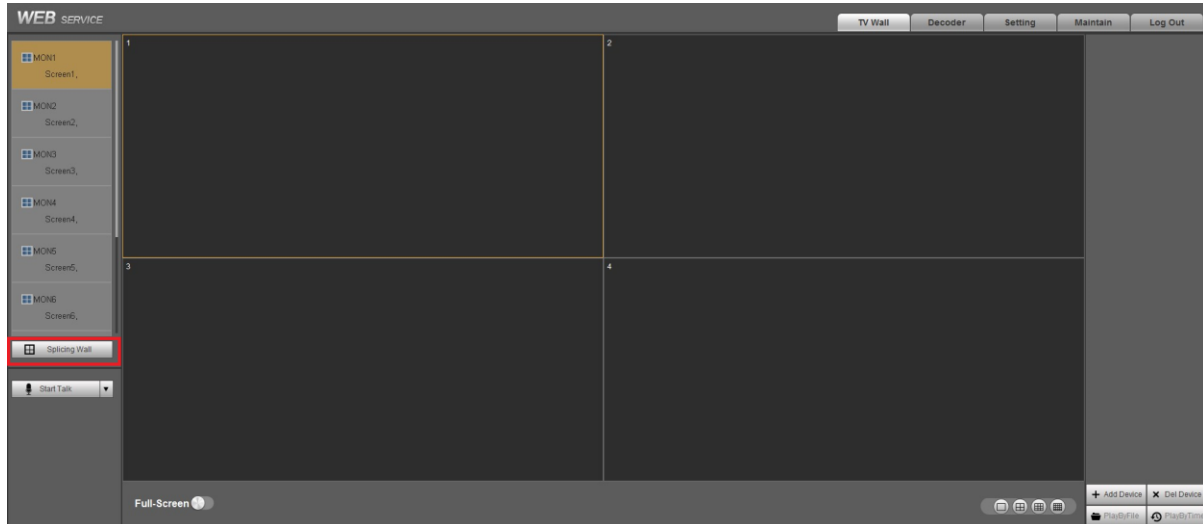

Figure 5-1

Click the Splicing wall on the left pane; you can go to the following interface. See Figure 5-2.

Click Fast splicing button, you can realize 1×1 setup conveniently.

For the network keyboard, it support 2×2 and etc splicing setup. Please follow the steps listed below.

- 1) Click Fast splicing button.
- 2) Select the screen and then click the Delete button; you can see the deleted screen becomes grey.
- 3) Click Ctrl button to select screens you want to delete at the same time. And then click the Splice button; it becomes 2×2 splicing screen.

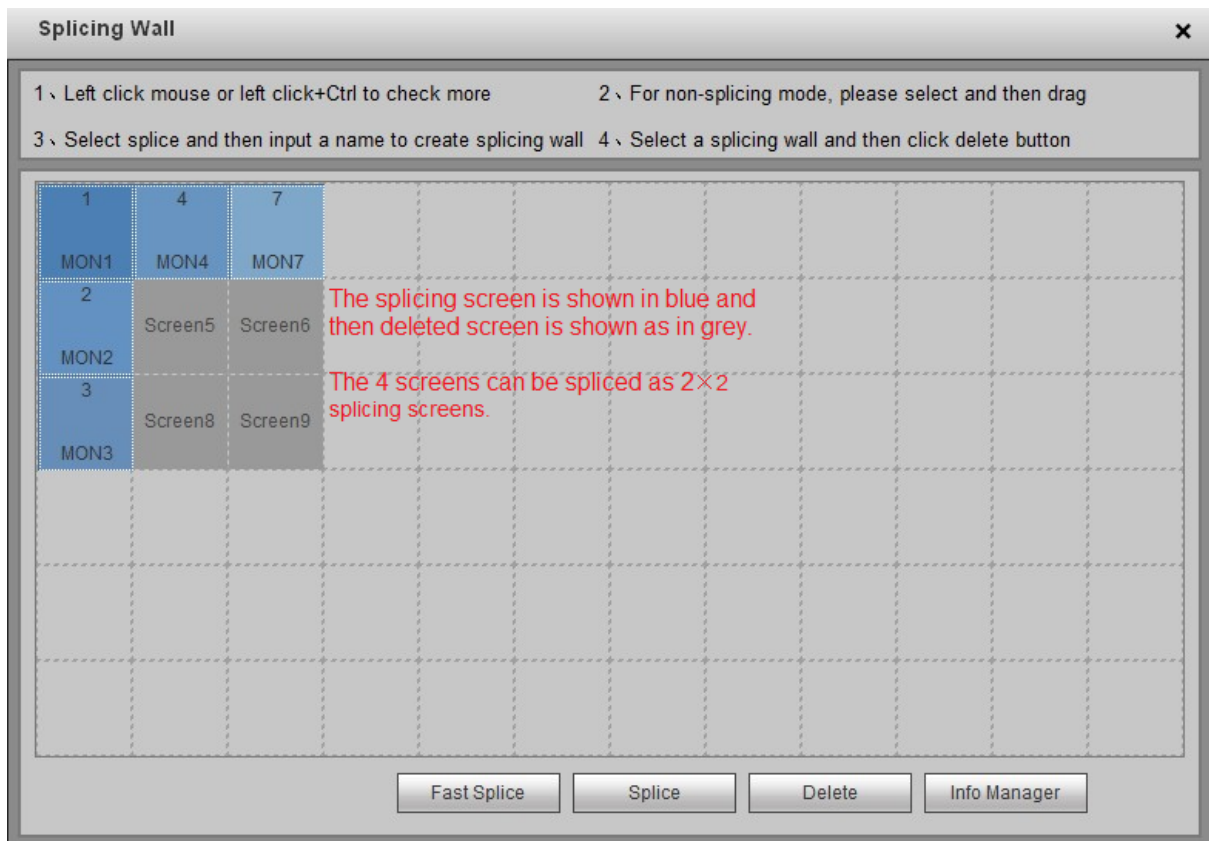

Figure 5-2

In Figure 5-2.click Info manager button, you can view and edit the corresponding screen control SN.

For network keyboard, click the **【Control ID】** + **【PLAY】** one by one, you can select the output screen quickly. See Figure 5-3.

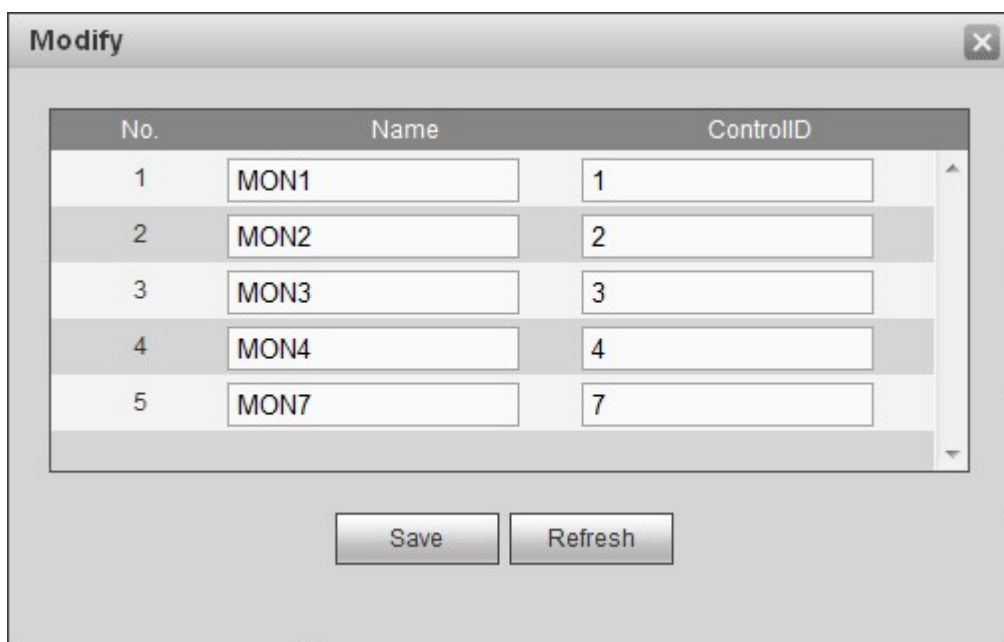

Figure 5-3

5.2 Output Video to the TV wall

Login the WEB of the decoder, from **【Setting】** -> **【Remote device】** , you can add the corresponding input source. Click the edit button  ,you can edit the correspondong control SN. See Figure 5-4.

For network keyboard, click the **【Control ID】** + **【CAM】** , you can output the video to the TV wall.

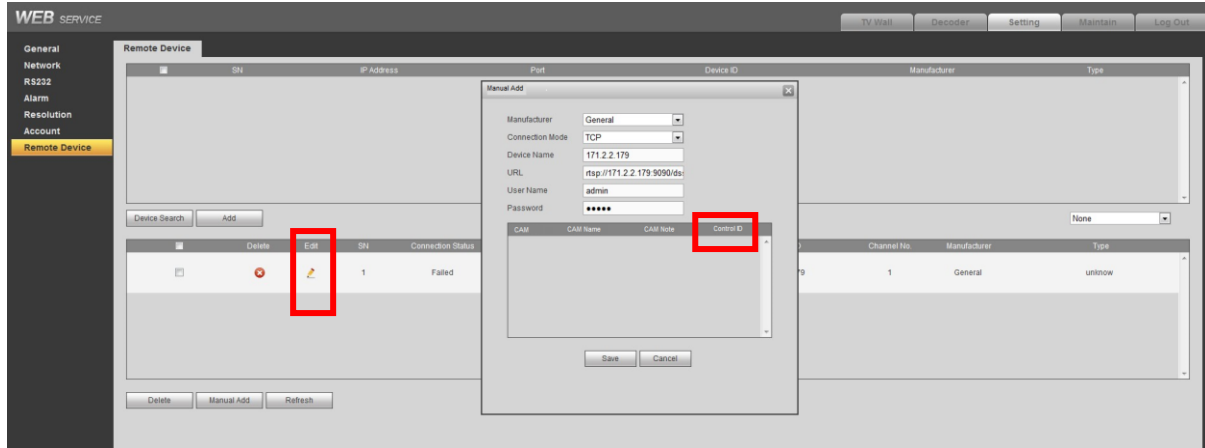

Figure 5-4

5.3 Zone Settings via the Keyboard

Please refer to chapter 2.3.2 Zone (control point) for detailed information.

The device type is NVD and step default value is 64.

6 Network Keyboard to Control Analog Matrix

Please refer to chapter 8.1 to use RS232 COM to connect the network keyboard to the analog matrix.

6.1 Analog Matrix Operation

Network keyboard can control the analog matrix to realize the following function. See Figure 6-1.



Figure 6-1

- 1) Check can use the front panel to switch the video or not.
 - Cable connection: If connect the video source to the No.32 input port of the matrix, connect the screen to the No.16 output of the matrix.
 - Operation: On the matrix, click **【32】** + **【Mode】** + **【16】** + **【Enter】** one by one.
 - Results: The video switch successfully once you can see “SWITCH OK” on the matrix screen.
- 2) Check the parameter setups.
 - Click **【Menu】** +1 one by one, check the baud rate setup of the matrix is OK or not.
 - Click **【Menu】** +2 one by one, check the RS232 address of the matrix is the same as the keyboard control point setup.
 - Click **【Menu】** +3+ **【Enter】** +1 consecutively, you can see the prompt “RS232 SET OK! ”. Check the RS232 protocol setup of the matrix is right or not.

6.2 Keyboard Operation

When you are using the network keyboard to control the analog matrix, please click the **【No.】** + **【CAM】** , you can use the front panel of the matrix to switch the video.

For example, click **【016】** + **【032】** + **【CAM】** , you can switch the 32nd channel video input of the front panel of the matrix to the 16th output channel.

Note

Please refer to chapter 2.3.2 Zone (control point) for detailed information. The device type is MATRIX.

7 Network Keyboard to Control Video Matrix Platform

7.1 Splicing Screen Control

Login the WEB of the video matrix platform (M60/M70), and then select splice control you can go to the following interface. See Figure 7-1.

The network keyboard supports TV wall combination on the video matrix platform. You can add the video wall you want to control as the splicing screen and then add the plan for each TV wall.

- Follow the steps listed below to add the plan.
 - 1) Select **【Row/column】** and then click **【add】** button.
 - 2) Select the corresponding decoded slot and then click **【Save】** .
 - Follow the steps listed below to control the splicing screen.
 - 1) Click **【Splice】**
 - 2) **【CTRL+Left click mouse】** to select several screens at the same time.
 - 3) Click **【OK】** to splice several screens.
- Click **【Cancel】** , you can cancel the splicing operation.
- Each screen can set corresponding split mode such as 1|4|9|16.
 - Click the **【Control ID】** + **【PLAY】** , you can quickly select the output screen.

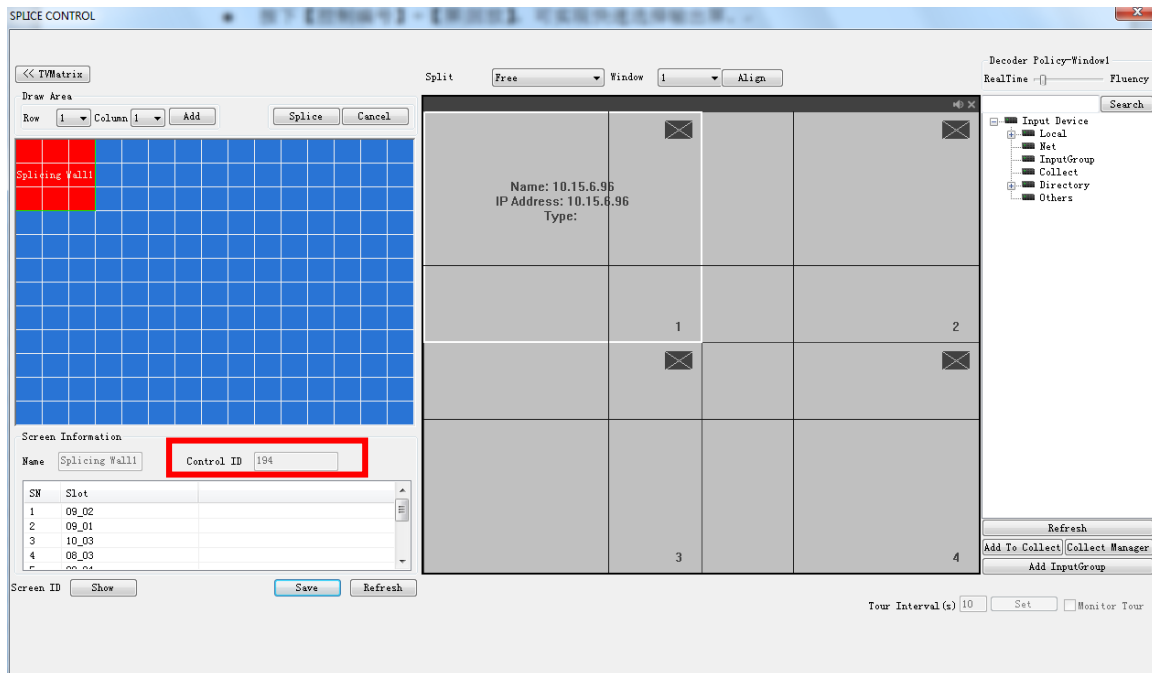

Figure 7-1

7.2 Output Video to the Wall

Login the Web of the video matrix platform (M60/M70).

- From **【Setting】** -> **【Input Title】** , you can edit the corresponding control SN of the local input signal. See Figure 7-2.
- From **【Setting】** -> **【Remote Device】** , double click the signal source, you can edit the control SN of the remote device. See Figure 7-3.

For network keyboard, click the **【Control ID】** + **【CAM】** one by one, you can output the video on the wall to preview.

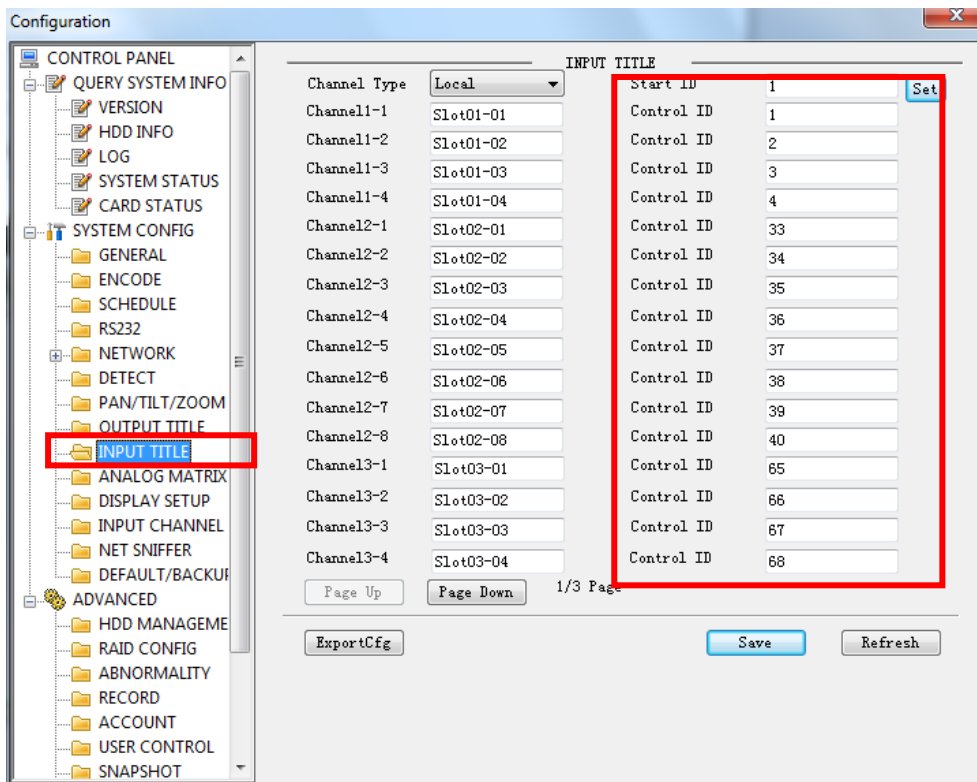

Figure 7-2

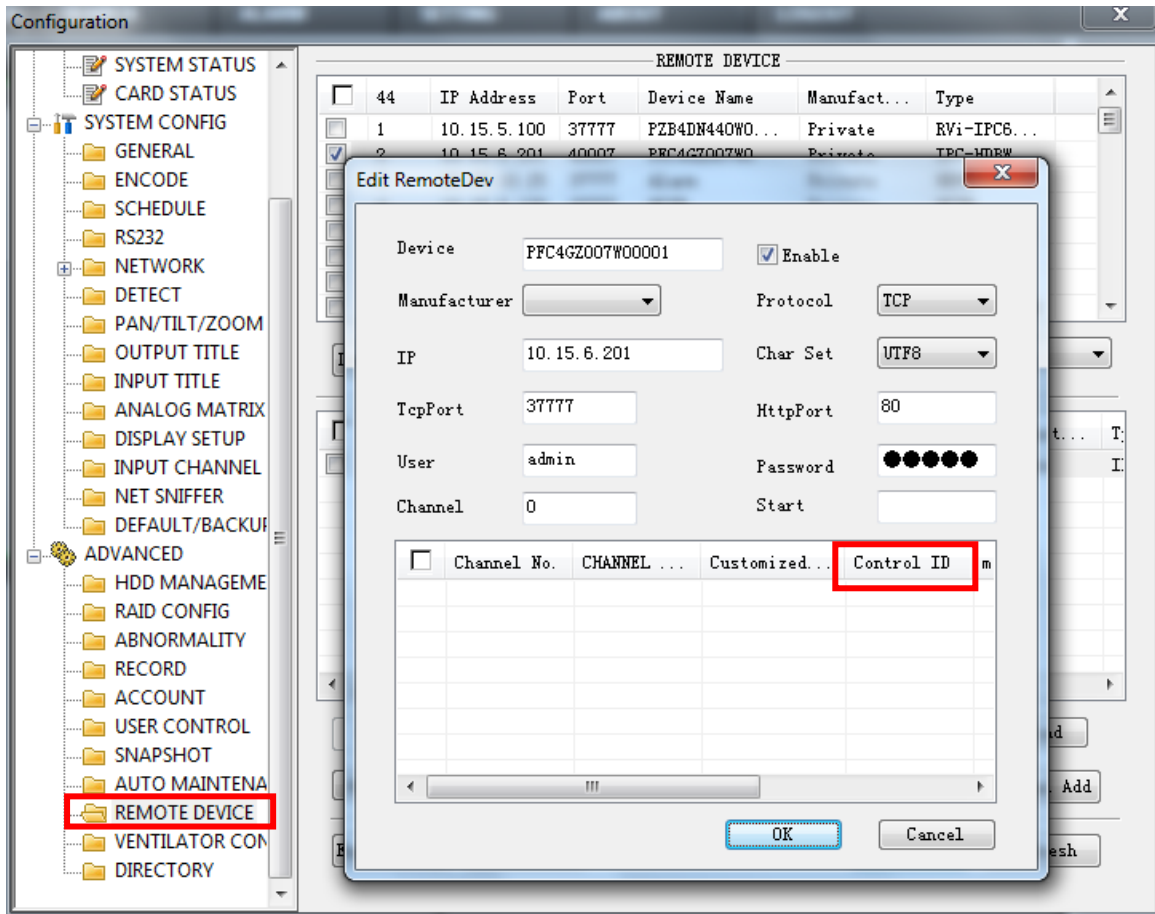

Figure 7-3

7.3 Zone Settings via the Keyboard

Please refer to chapter 2.3.2 Zone (control point) for detailed information.
 The device type is DVM and step default value is 64.

8 Make COM Cable

8.1 Make RS232 COM Cable

Please refer to the following figure to make RS232 cable.

When use the network keyboard to control the analog matrix, RS232 Com adopts the straight mode: 2-2, 3-3, 5-5. Straight through connection mode is shown as in Figure 8-1.



Figure 8-1

When use the keyboard to control other device, RS232 Com adopts the crossover connection mode: 2-3, 3-2, 5-5. Crossover connection mode is shown as in Figure 8-2.

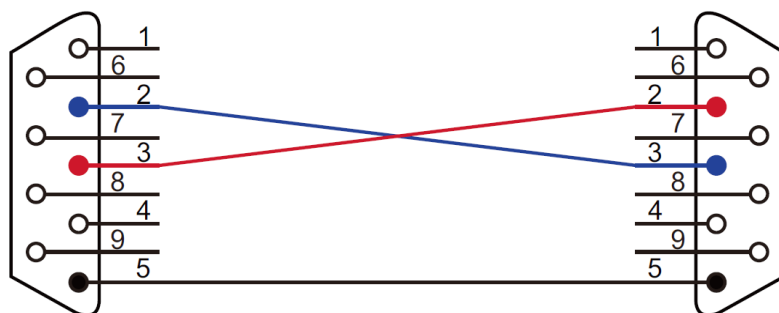

Figure 8-2

8.2 Make RS485 COM Cable

Note

- RS232 port can only connect to one DVR. If you want to control several DVRs at the same time, please use RS485 mode.
- RS485 BUS can connect to thirty-two 485->232 switcher boxes, one 485->232 switcher box can connect to 8 DVRs.

You can refer to Figure 8-3 if you are connecting the keyboard with the switcher box.

RS485 Port of Keyboard

RS485 Switch Box Port

(Green alarm socket)

(6-pin crystal)

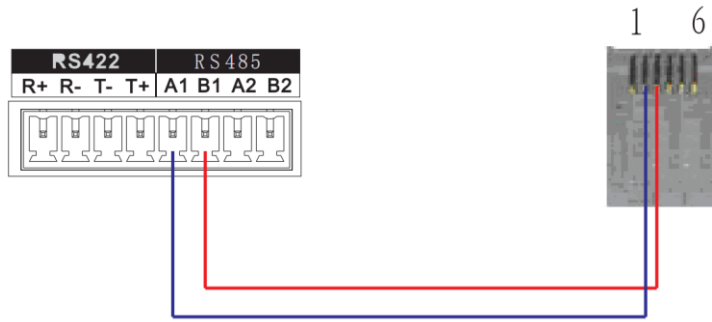

Figure 8-3

8.3 25-pin Port and Switch Box Connection

Connect switch 25-pin box RS232 port with DVR RS232 port. (25-pin outlet supports maximum twelve RS232 ports. Switch is just for sending not for receiving. So you can use two cables: GND and TXD)

Please refer to the following figure if you are connecting 485 switch box to DVR See Figure 8-4.

Note

485->232 switch box does not need the TXD cable. The 1 to 8 COM port already supports this function.

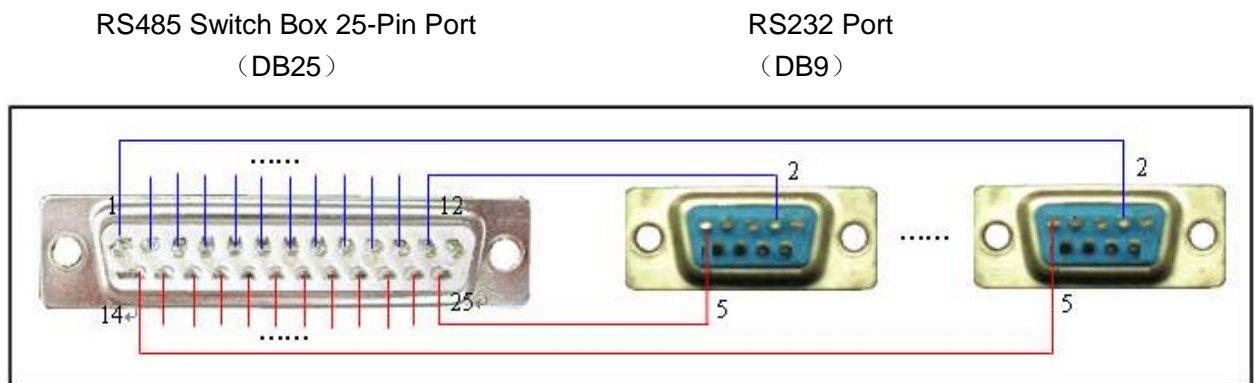

Figure 8-4

8.4 RJ45 Network Port Connection

If you are using network keyboard, you can use the network to connect.

The direct connection mode is shown as below. See Figure 8-5.

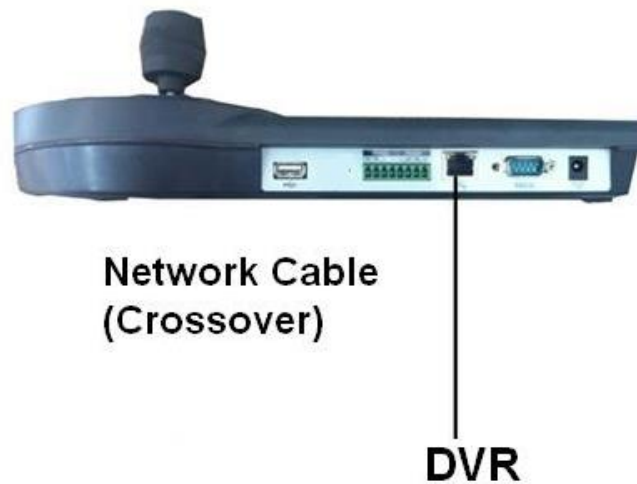

Figure 8-5

Please refer to the following figure if you are connecting via the hub. See Figure 8-6.

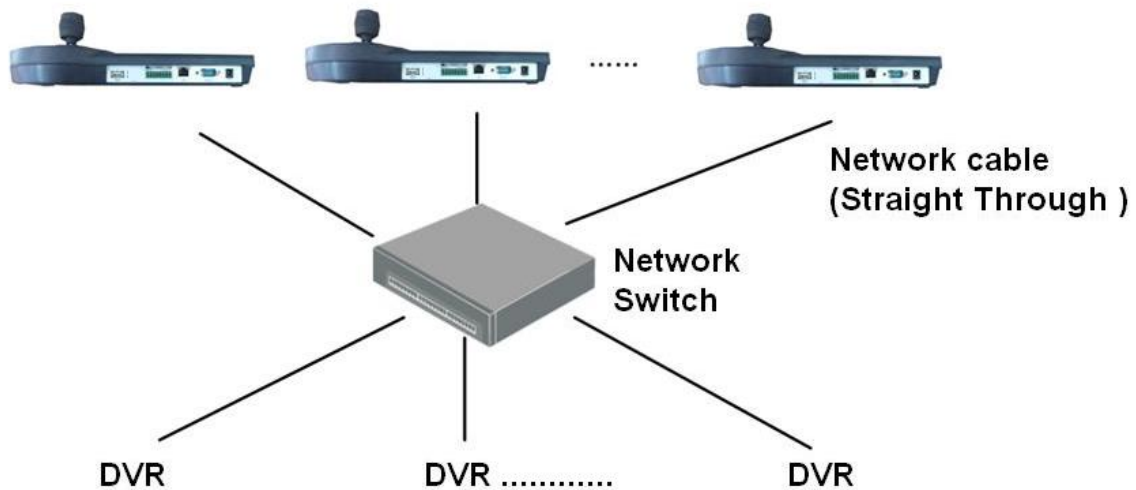

Figure 8-6

Note:

- This quick start guide is for reference only. Slight difference may be found in the user interface.
- All the designs and software here are subject to change without prior written notice.
- All trademarks and registered trademarks mentioned are the properties of their respective owners.
- If there is any uncertainty or controversy, please refer to the final explanation of us.
- Please visit our website for more information.