

# BG-UM44-150L-KIT

**4X4 4K 18Gbps UHD HDMI/HDBaseT Matrix Switcher with 2-Way  
IR/Advanced EDID/Downscaling/IP and RS-232 Control**

## User Manual







## TABLE OF CONTENTS

Statement	4
Safety Precaution	4
Introduction	5
Features	5
Packing List	6
Specifications	7
Operation Controls and Functions	8
IR Remote	11
IR Control System	11
IR Cables	13
EDID Management	14
Web GUI User Guide	16
RS-232 Control Commands	26
Application Example	31
BZBGear Switch Control App	32
Tech Support	35
Limited Product Warranty Terms	35
Mission Statement	36
Copyright	36



## Statement

---

Please read these instructions carefully before connecting, operating, or configuring this product. Please save this manual for future reference.

## Safety Precaution

---

- To prevent damaging this product, avoid heavy pressure, strong vibration, or immersion during transportation, storage, and installation.
- The housing of this product is made of organic materials. Do not expose to any liquid, gas, or solids which may corrode the shell.
- Do not expose the product to rain or moisture.
- Unplug this device during lightning storms
- Clean only with a soft dry microfiber cloth.
- To prevent the risk of electric shock, do not open the case. Installation and maintenance should only be carried out by qualified technicians.
- Do not use the product beyond the specified temperature, humidity, or power supply specifications.
- This product does not contain parts that can be maintained or repaired by users. Damage caused by dismantling the product without authorization from BZBGear is not covered under the warranty policy.
- Installation and use of this product must strictly comply with local electrical safety standards.
- Only use accessories specified by the manufacture
- Product specifications may be subject to technical upgrades without further notice



## Introduction

---

The BG-UM44-150L-KIT is an 18Gbps 4x4 HDBaseT(150M) matrix. It features four HDMI inputs and four HDMI outputs which are mirrored to four HDBaseT category cable outputs which run simultaneously. The system can support resolutions up to 4K2K@60Hz 4:4:4 and each HDMI output supports 4K2K to 1080P downscaling independently.

The HDBaseT outputs can extend video transmission distance via Cat 5e/6/7 up to 492ft (150m) at 1080p and 4K2K up to 394ft (120m). While achieving long distances and high resolutions the BG-UM44-150L also supports a variety of HDR formats such as HDR10+, Dolby Vision, and HLG for rich colors.

The BG-UM44-150L-KIT can de-embed audio to stereo analog and digital coaxial on the transmitter and 3.5mm stereo on the HDBaseT receivers. HDMI audio pass-through supports up to 7.1CH HD audio in a variety of formats like Dolby TrueHD. The system also supports IR matrixing.

The IR signal is one-to-one control at the matrix end and the IR signal follows HDMI video channels at the HDBaseT receiver end. To simplify installation, the receivers support power over cable (PoC) so no additional power supply is needed. The BG-UM44-150L-KIT provides an intuitive front panel OLED screen and control via physical panel buttons, IR remote, RS-232, LAN, or Web GUI.

## Features

---

- HDMI 2.0b, HDCP 2.2 and HDCP 1.x compliant
- Video resolution up to 4K2K@60Hz (YUV 4:4:4) on all HDMI & HDBaseT ports
- 4 HDMI inputs and 4 HDMI / HDBaseT mirrored outputs
- HDMI ports transmit 18Gbps lossless uncompressed video bandwidth
- 18Gbps lossless compressed HDBaseT signal transmission
- 4K->1080P down scaler for each output port
- HDR, HDR10, HDR10+, Dolby Vision, HLG are supported
- HDBaseT output can extend video transmission distance up to 492ft / 150m for 1080P or 394ft / 120m for 4K2K via a single Cat 5e/6/7 cable
- HDMI audio pass-through up to 7.1CH HD audio (LPCM, Dolby TrueHD and DTS-HD Master Audio)
- IR matrix
- Audio de-embedding via analog and coax ports
- Advanced EDID management and CEC control
- 24V PoC on all HDBaseT ports
- 1U rack mounted design with front panel OLED display
- Control via front panel buttons, IR remote, RS-232, LAN and Web GUI



## Packing List

---

- 1 x 18Gbps 4x4 HDBaseT (150M) Matrix
- 4 x HDBaseT Receiver
- 1 x Matrix IR Remote
- 1 x 100~240V AC 50/60Hz Power cable
- 1 x RS-232 serial cable (1.5 meters, male to female head)
- 4 x 3-pin Phoenix Connector & 4 x 5-pin Phoenix Connector
- 5 x IR Blaster cable (1.5 meters)
- 5 x IR Receiver cable (1.5 meters)
- 10 x Mounting Ear (Matrix and Receiver)
- 1x User Manual



## Specifications

Technical			
HDMI Compliance	HDMI 2.0b		
HDCP Compliance	HDCP 2.2 and HDCP 1.x		
Video Bandwidth	18Gbps		
Video Resolution	Up to 4K2K@50/60Hz (4:4:4)		
Color Space	RGB 4:4:4, YCbCr 4:4:4/2:2/4:2:0		
Color Depth	8-bit, 10-bit, 12-bit (1080p@60Hz) 8-bit (4K2K@60Hz YUV4:4:4) 8-bit, 10-bit, 12-bit (4K2K@60Hz YCbCr 4:2:2/4:2:0)		
HDR	HDR10, HDR10+, Dolby Vision, HLG		
HDMI Audio Formats	LPCM 2.0/2.1/5.1/6.1/7.1, Dolby Digital, Dolby TrueHD, Dolby Digital Plus (DD+), DTS-ES, DTS HD Master, DTS HD-HRA, DTS-X		
Coax Audio Formats	PCM 2.0, Dolby Digital / Plus, DTS 2.0/5.1		
Analog Balanced Audio Formats	PCM 2.0 CH		
V <sub>max</sub>	2 V <sub>rms</sub>		
SNR	> 90dB		
THD+N Ratio	< 0.1% (V <sub>max</sub> ) 0.001%~0.01% (V <sub>best</sub> )		
Crosstalk	> 80dB		
Frequency Response	20Hz~20kHz ±0.5dB		
ESD Protection	Human-body Model: ±8kV (Air-gap discharge), ±4kV (Contact discharge)		
Connection			
Matrix	Inputs: 4 x HDMI Type A [19-pin female] Outputs: 4 x HDMI Type A [19-pin female] 4 x HDBaseT port [RJ45] 4 x Coaxial audio [3.5mm Stereo Mini-jack] 4 x Balanced analog audio [5-pin Phoenix connector] Controls: 5 x IR IN [3.5mm Stereo Mini-jack] 5 x IR OUT [3.5mm Stereo Mini-jack] 1 x TCP/IP [RJ45] 1 x RS-232 [D-Sub 9]		
HDBaseT Receiver	Input: 1 x HDBT IN [RJ45, 8-pin female] Outputs: 1 x HDMI Type A [19-pin female] 1 x AUDIO OUT [3.5mm Stereo Mini-jack] Controls: 1 x IR IN [3.5mm Stereo Mini-jack] 1 x IR OUT [3.5mm Stereo Mini-jack] 1 x RS-232 [3-pin Phoenix connector] 1 x SERVICE [Mini-USB, Update port]		
Mechanical			
Housing	Metal Enclosure		
Color	Black		
Dimensions	Matrix: 440mm (W) x 200mm (D) x 44.5mm (H) Receiver: 140mm (W) x 65mm (W) x 18mm (W)		
Weight	Matrix: 3.1Kg, Receiver: 155g		
Power Supply	AC 100 - 240V 50/60Hz		
Power Consumption	60W (Max)		
Operating Temperature	0°C ~ 40°C / 32°F ~ 104°F		
Storage Temperature	-20°C ~ 60°C / -4°F ~ 140°F		
Relative Humidity	20~90% RH (non-condensing)		
Resolution / Distance	4K60 - Feet / Meters		
CAT5e/6/7	492ft / 150M		
Resolution / Cable length	4K60 - Feet / Meters	4K30 - Feet / Meters	1080P60 - Feet / Meters
HDMI IN / OUT	16ft / 5M	32ft / 10M	50ft / 15M

The use of “Premium High-Speed HDMI” cables is highly recommended.



# Operation Controls and Functions

## Matrix Panel

### Front Panel

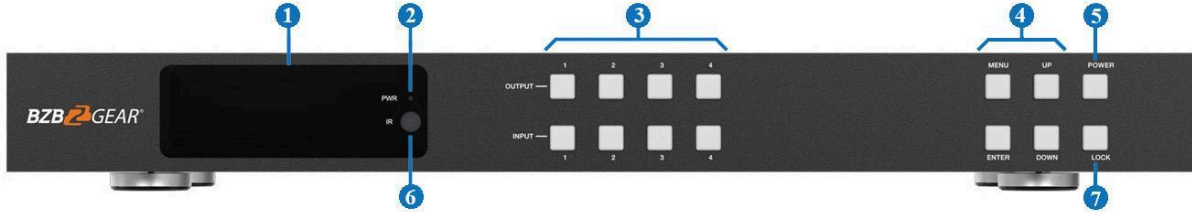

NO.	Name	Function Description
1	LED screen	Display matrix switching status, input / output port, EDID, Baud rate, and IP Address.
2	Power LED	The LED will illuminate green when the unit is working normally and red when the unit is in standby.
3	OUTPUT / INPUT buttons	Press an output button (1~4) first and then press an input button (1~4) to select the corresponding input source for the output port.
4	MENU / ENTER / UP / DOWN	<p>① <b>EDID setting:</b> On the initial OLED display screen, press the “MENU” button to enter the menu and then Enter on “Select EDID” interface, press “UP/DOWN” button to select the required EDID and press the “ENTER” button to enter “Copy to Input.” Press the “UP/DOWN” button to select the input port you need to set, and press “ENTER” again to confirm.</p> <p>② <b>Baud rate setting:</b> On the initial OLED display screen, press “MENU” button twice to enter “SELECT BAUD” interface, and press “UP/DOWN” button to select the required Baud rate, finally press the “ENTER” button to confirm the setting.</p> <p>③ <b>IP Address Check:</b> On the initial OLED display screen, press “MENU” button three times to enter the IP interface and check the current IP address, then press “UP/DOWN” button to switch DHCP ON/OFF, finally press the “ENTER” button to confirm the setting. Pressing the “MENU” button again will return to the initial OLED display status.</p>
5	POWER button	Press and hold the POWER button for 3 seconds to enter the standby mode, then press the button again to wake up the device.
6	IR Window	IR receiver window: it only receives the IR remote signal from this product.
7	LOCK button	Press the LOCK button to lock front panel buttons (Except the power button); Press the button again to unlock.



Rear Panel

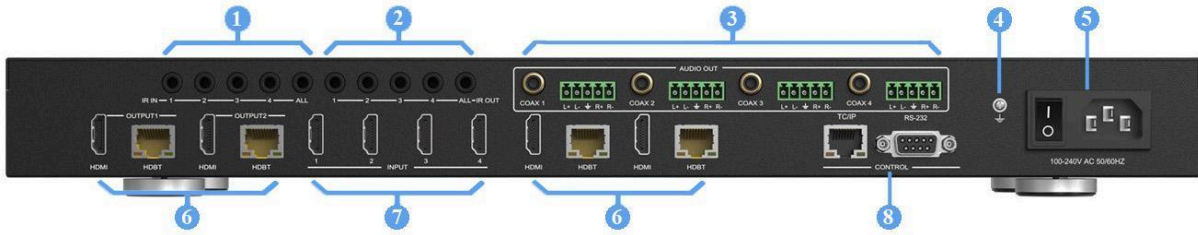

No.	Name	Function Description
1	IR IN (1/2/3/4/ ALL) ports	Connect to the IR receiver cable, the IR receive signal will be sent to the "IR OUT" port of the HDBaseT receiver.
2	IR OUT (1/2/3/4/ ALL) ports	Connect to the IR blaster cable, the IR emit signal will be from the "IR IN" port of the HDBaseT receiver.
3	AUDIO OUT (1-4) ports	4 groups of coaxial and balanced analog audio mirrored output ports. AUDIO OUT (1-4) follows the video output of OUTPUT (1-4) ports.
4	GND	Connect the housing to the ground.
5	POWER input	Power port: Connect to 100~240V AC 50/60Hz power cable. Power switch: Press the switch to turn on/off the power.
6	OUTPUT (1-4) ports	HDMI output ports: connect to a HDMI display device such as a TV or monitor. HDBT mirrored output ports: connect to HDBaseT receiver via CAT cable.
7	INPUT (1-4) ports	HDMI input ports: connect to a HDMI source device such as BluRay Player.
8	CONTROL ports	TCP/IP: Connect to an active Ethernet link with an RJ45 cable for TCP/IP control. RS-232: Command control port. Connect to a PC or control system with a D-Sub 9-pin cable to control the matrix.



- Solid: HDMI signal with HDCP.
- Flashing: HDMI signal without HDCP.
- Dark: No HDMI signal.
- Solid: Matrix and HDBaseT Receiver are in good connection status.
- Flashing: Matrix and HDBaseT Receiver are in poor connection status.
- Dark: Matrix and HDBaseT Receiver are not connected.



## HDBaseT Receiver Panel

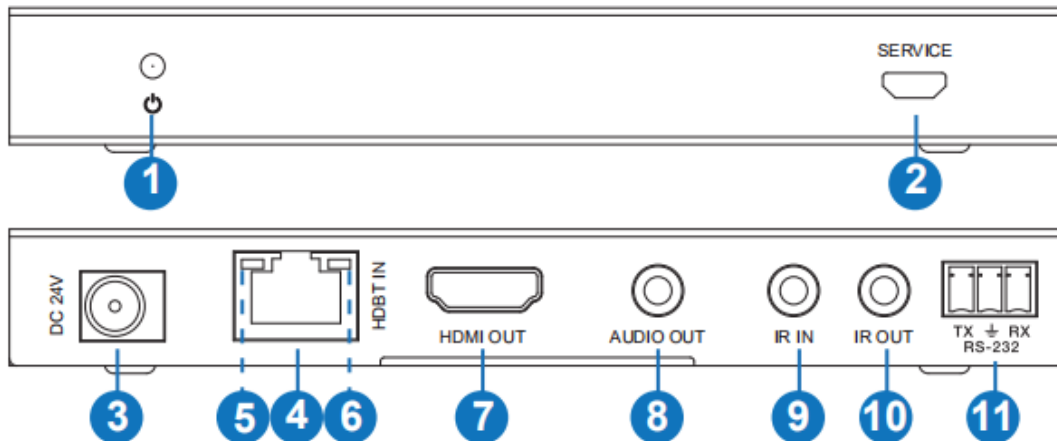

No.	Name	Function Description
1	Power LED	Red LED will be on when the receiver is powered on.
2	SERVICE port	Firmware update port.
3	DC 24V	DC 24V/1A power supply input port. Note: The Matrix supports PoC functionality which means that the receiver does not need a power supply.
4	HDBT IN	RJ45 connector for connecting the HDBT OUTPUT port of Matrix with a CAT cable.
5	Connection Signal Indicator lamp	<ul style="list-style-type: none"> <li>• Solid: Matrix and Receiver are in good connection status.</li> <li>• Flashing: Matrix and Receiver are in poor connection status.</li> <li>• Dark: Matrix and Receiver are not connected.</li> </ul>
6	Data Signal Indicator	<ul style="list-style-type: none"> <li>• Solid: HDMI signal with HDCP.</li> <li>• Flashing: HDMI signal without HDCP.</li> <li>• Dark: No HDMI signal.</li> </ul>
7	HDMI OUT	HDMI output port: connect to HDMI display device such as TV or monitor.
8	AUDIO OUT	Analog audio output port: the audio is extracted from the HDMI signal.
9	IR IN	Connect to the IR receiver cable, the IR receive signal will be sent to the "IR OUT" port of the matrix.
10	IR OUT	Connect to the IR blaster cable, the IR signal will be from the "IR IN" port of the matrix.
11	RS-232	Connect to a PC or control system with a 3-pin phoenix connector cable to transmit commands between the matrix and HDBaseT receiver.



## IR Remote

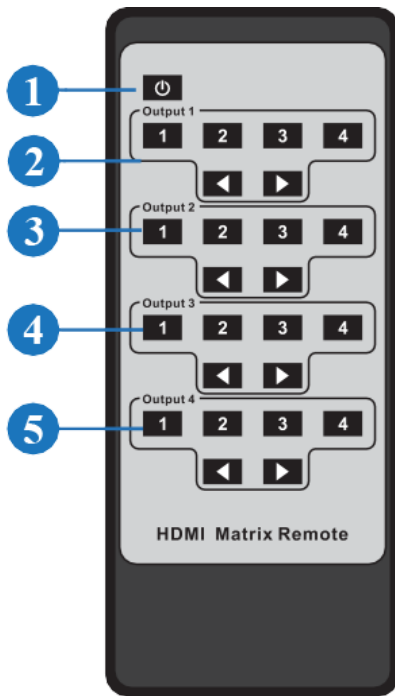

1. **Power on or Standby:** Power on the Matrix or set it to standby mode.
2. **Output 1:** Press 1\2\3\4 button to select input source to HDMI OUTPUT 1.
3. **Output 2:** Press 1\2\3\4 button to select input source to HDMI OUTPUT 2.
4. **Output 3:** Press 1\2\3\4 button to select input source to HDMI OUTPUT 3.
5. **Output 4:** Press 1\2\3\4 button to select input source to HDMI OUTPUT 4.

Select the last ◀ or next ▶ input source button.

## IR Control System

The BG-UM44-150L-KIT is not only a matrix switch but also an extender that supports bi-directional IR control. When the matrix is connected to a HDBaseT receiver through a Cat 5e/6/7 cable, you can control the remote display device (HDBaseT) or input source device (matrix) through an IR signal transmission. NOTE: The IR signal transmission method is different from matrix (local) to HDBaseT receiver (remote) and from HDBaseT receiver (remote) to matrix (local).

**At the matrix (local end):** the IR signal is one-to-one transmission. For example, the IR IN 1 port signal of the matrix will emit to the IR OUT port of the HDBaseT Receiver 1, and the IR IN 3 port of the matrix will emit a signal to the IR OUT port of the HDBaseT Receiver 3. It does not follow the video switch/change. The IR IN ALL port of the matrix will emit to all IR OUT ports of HDBaseT receivers simultaneously. Please see the following connection diagram.

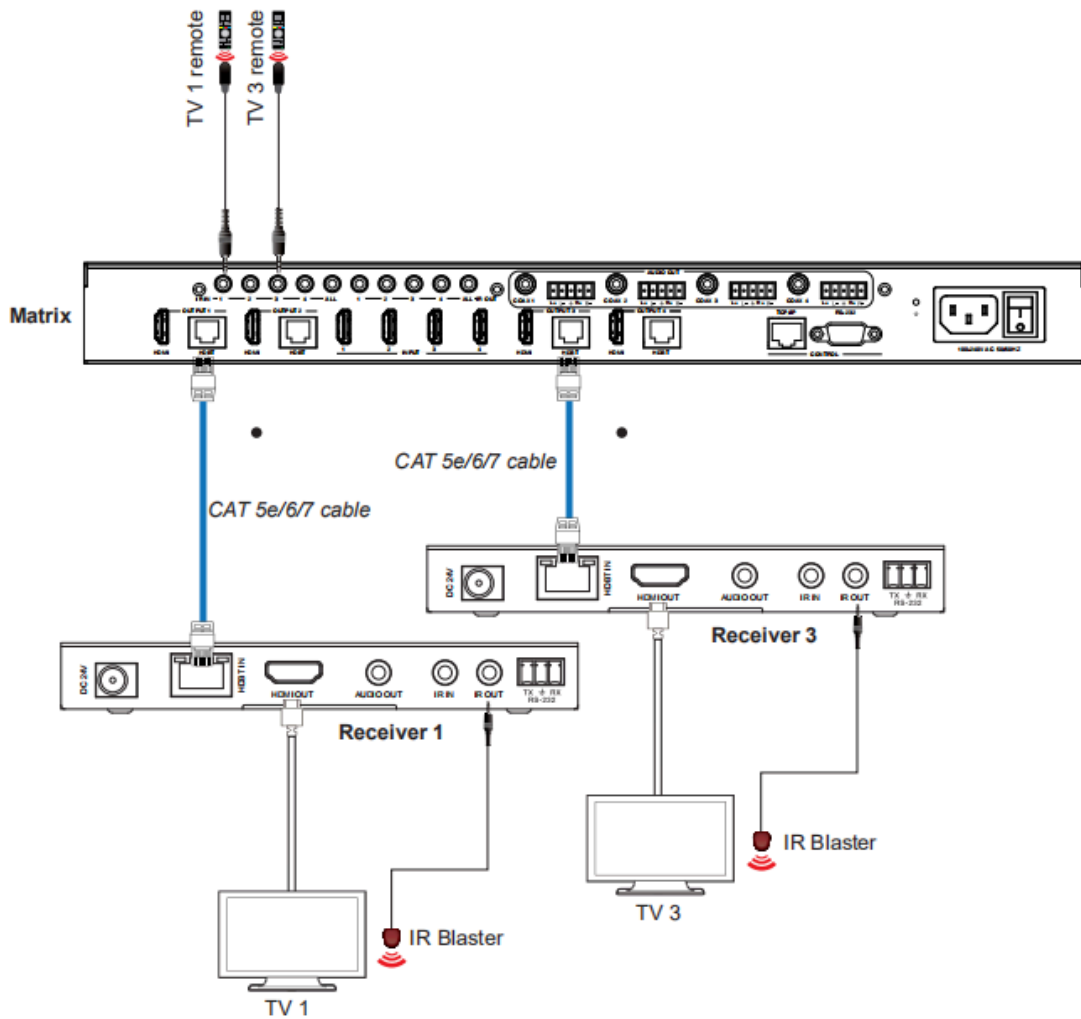

**Figure 1: IR connection diagram (Matrix end)**

**At HDBaseT Receiver (Remote end):** IR signal follows video switch/change.

For example, the HDMI output signal on the HDBaseT Receiver 1 is from the HDMI INPUT 2 port, so the IR input signal of the HDBaseT Receiver 1 will emit to IR OUT 2 of the matrix. The HDMI output signal on the HDBaseT Receiver 3 is from the HDMI INPUT 4 port. Then, the IR input signal of the HDBaseT Receiver 3 will emit to IR OUT 4 of the matrix etc. Any HDBaseT receiver's IR IN signal can output from the IR OUT ALL port of the matrix and the IR OUT ALL signal of the matrix depends on your IR remote source device. Please see the following connection diagram.

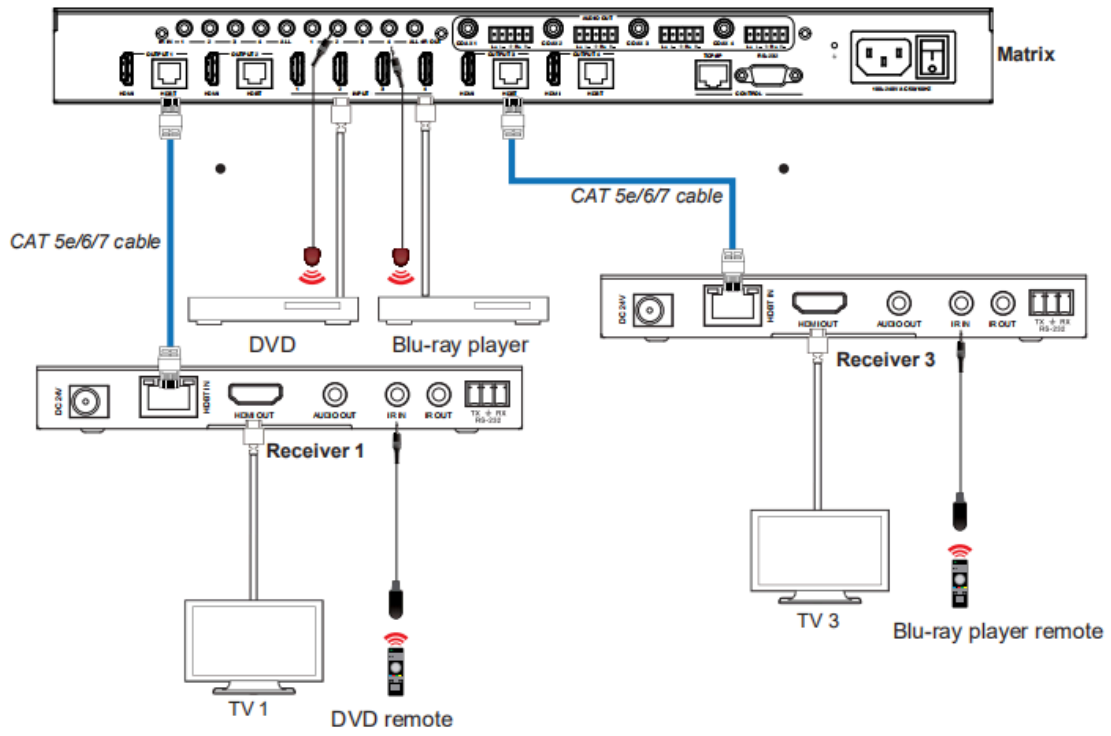
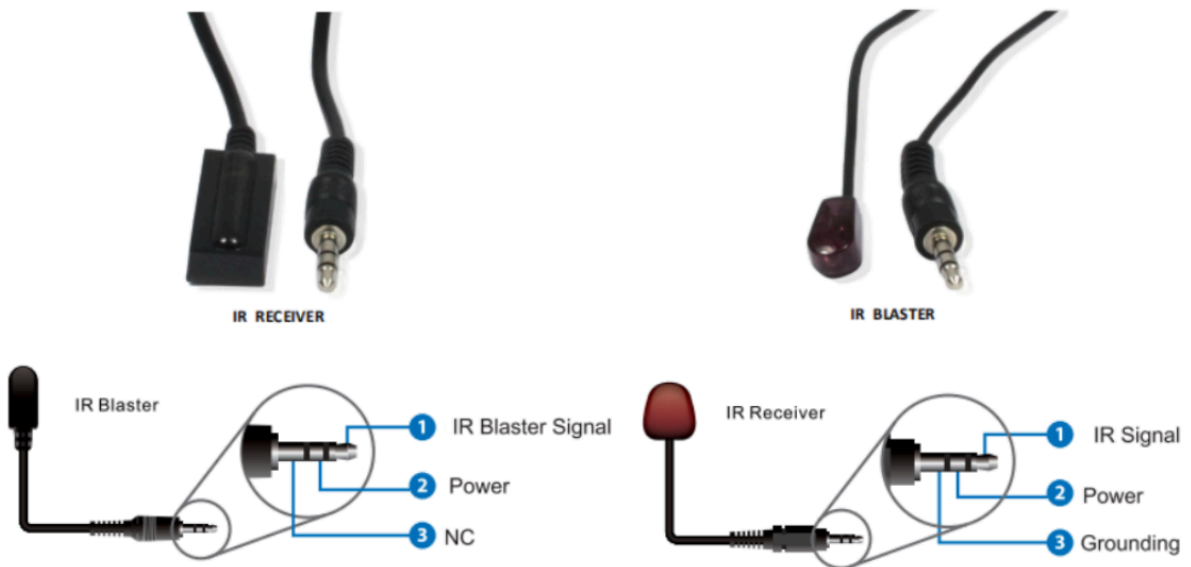

Figure 2: IR connection diagram (HDBaseT Receiver end)

## IR Cables





## EDID Management

This BG-UM44-150L-KIT has 21 factory defined EDID settings, 2 user-defined EDID modes and 8 copy EDID modes. You can select a defined EDID mode or copy EDID mode through the on-panel buttons, RS-232 control, or web interface.

**On-panel button operation:** On main OLED display screen, press the “MENU” button to enter the EDID setting interface, press “UP/DOWN” button to select the required EDID, and press the “ENTER” button to enter “Copy to Input:” interface. Then press the “UP/DOWN” button to select the input port you need to set, and press “ENTER” again to confirm.

**RS-232 control operation:** Connect the matrix to a PC with a serial cable, then open a serial command tool on the PC to send ASCII command “s edid in x from z!” to set EDID. For details, please refer to “EDID Setting” in the ASCII command list in Section 11 “RS-232 Control Commands”.

**Web Interface:** Please check EDID management in the “Input Setting” in section 10 “Web GUI User Guide.”

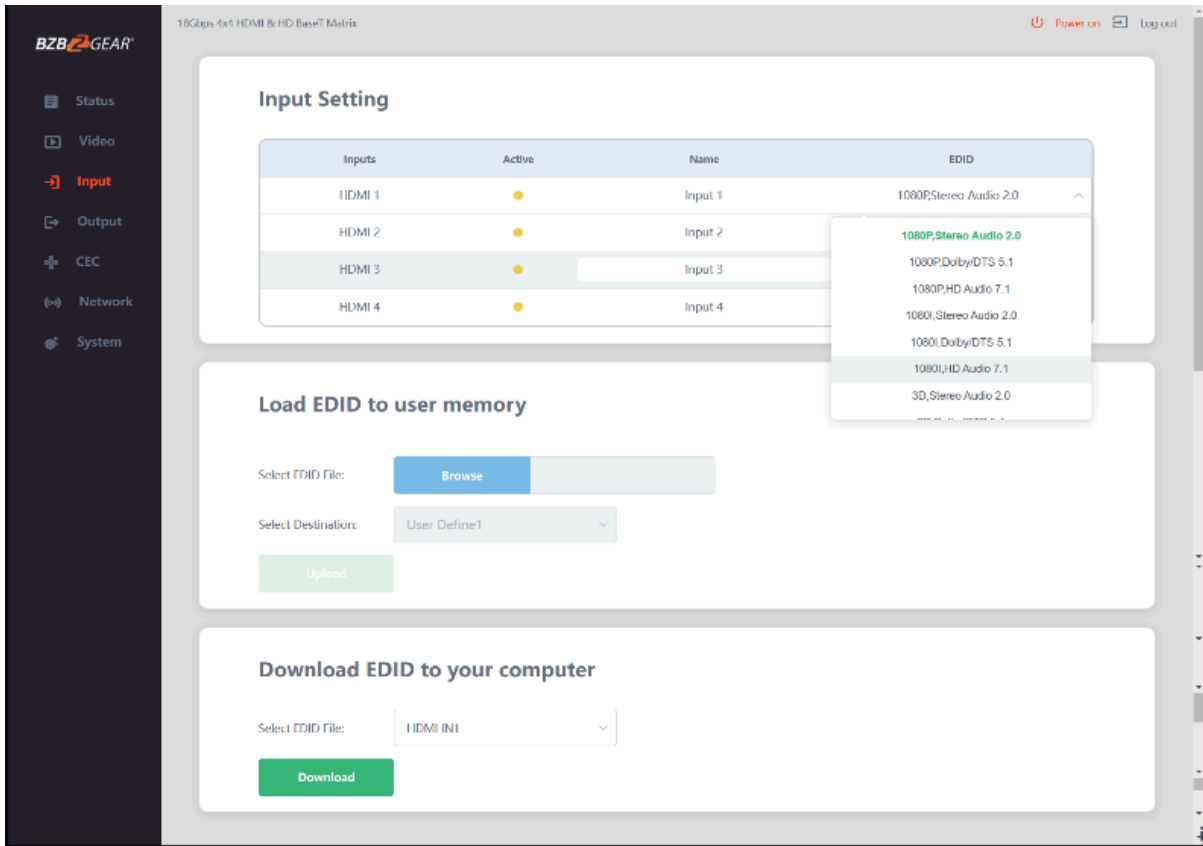



## EDID Settings:

EDID Mode	EDID Description
1	1080p, Stereo Audio 2.0
2	1080p, Dolby/DTS 5.1
3	1080p, HD Audio 7.1
4	1080i, Stereo Audio 2.0
5	1080i, Dolby/DTS 5.1
6	1080i, HD Audio 7.1
7	3D, Stereo Audio 2.0
8	3D, Dolby/DTS 5.1
9	3D, HD Audio 7.1
10	4K2K30_444, Stereo Audio 2.0
11	4K2K30_444, Dolby/DTS 5.1
12	4K2K30_444, HD Audio 7.1
13	4K2K60_420, Stereo Audio 2.0
14	4K2K60_420, Dolby/DTS 5.1
15	4K2K60_420, HD Audio 7.1
16	4K2K60_444, Stereo Audio 2.0
17	4K2K60_444, Dolby/DTS 5.1
18	4K2K60_444, HD Audio 7.1
19	4K2K60, Stereo Audio 2.0 HDR
20	4K2K60, Dolby/DTS 5.1 HDR
21	4K2K60, HD Audio 7.1HDR
22	User defined 1
23	User defined 2
24~27	Copy from HDMI OUTPUT 1~4
28~31	Copy from HDBT OUTPUT 1~4



## Web GUI User Guide

---

The matrix can be controlled through a web interface and operation is shown below.

**Step 1:** Get the current IP Address.

The default IP address is 192.168.1.100. You can get the current matrix IP address in two ways:

1. You can get the IP address using the front panel buttons. On the initial OLED display, press the “MENU” button three times to enter the IP interface and check the current IP address.
2. You can get the IP address via RS-232 control. Send the ASCII command “ r ipconfig!” through a Serial Command tool, then you’ll get the feedback information as shown below:

```
IP Mode: DHCP
IP:192.168.62.109
Subnet Mask:255.255.255.0
Gateway:192.168.62.1
TCP/IP port:8000
Telnet port:23
Mac address:6c-df-fb-0c-b3-8e
```

IP: 192.168.62.109 in the above figure is the current matrix IP address (the IP address is variable depending on network configuration).

For a list of RS-232 controls, please refer to section 11. RS-232 Control Commands.

**Step 2:** Connect the TCP/IP port of the matrix to a PC with an ethernet cable (as shown in the following figure) and set the IP address of the PC to be in the same network as the matrix.

The computer must be on the same subnet as the matrix to connect successfully. The device will not be accessible otherwise. The units default IP address is 192.168.1.100, therefore the computer must be connected to the 192.168.1.x subnet.

To connect to the matrix, open the “Local Area Connection Properties” on the computer.

For Windows users right-click on the internet connection in the lower right corner of the desktop.

Select “**Open Network & Internet Settings**”.

Select “**Change Adapter Options**”.

Right-click on your connection (Wi-Fi or Ethernet) and select “**Properties**”.

Select “**Internet protocol version 4 (TCP/IPv4)**” as shown below and click “**Properties**”.

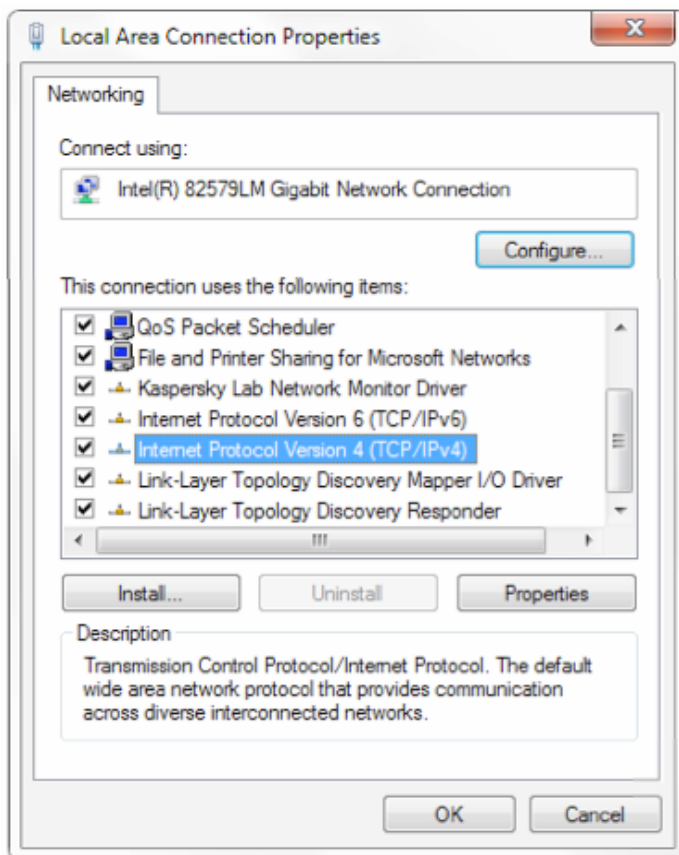

Click on the bubble for “**Use the following IP address**”

In the **IP address** field enter a non-conflicting IP address on the same subnet as the camera. If there is another device with the same IP address you will not be able to connect.

In the **Subnet mask** field enter 255.255.255.0

In the **Default gateway** field type 192.168.1.1

You can leave the DNS fields blank.

Click **OK** to apply your settings.

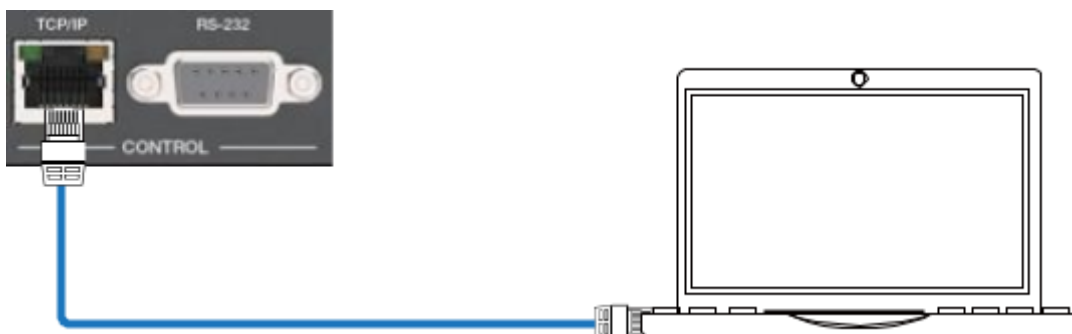

**Step 3:** Input the current IP address of Matrix into your browser on the PC to enter the web interface.





After entering the IP address of the unit in the browser the Login page will appear as shown below:

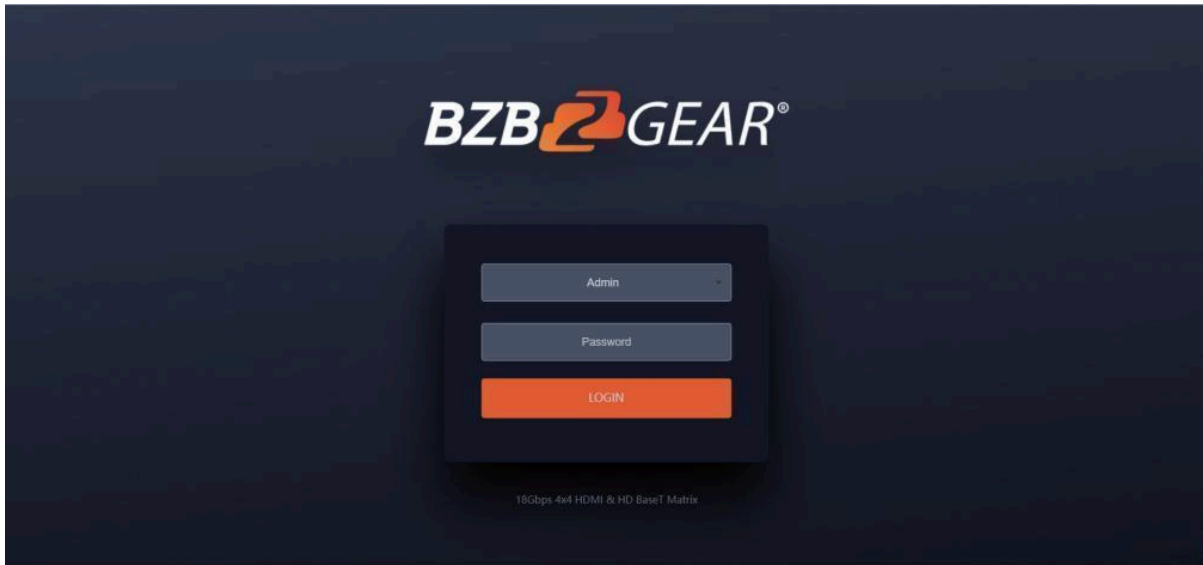

Select the Username from the list and enter the password. The default passwords are:

Username	<b>User</b>	<b>Admin</b>
Password	<b>user</b>	<b>admin</b>

After entering the password, click the “LOGIN” button and the following Status page will appear.

### Status Page

The “Status” page provides basic information about the product such as model, installed firmware version, and the network information of the device.

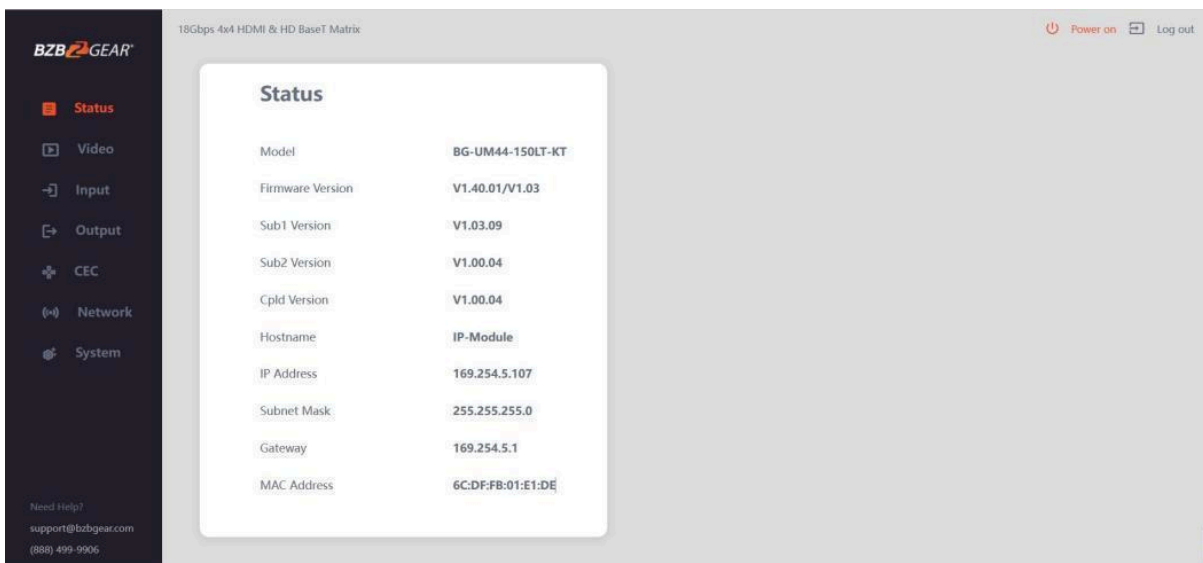



## Video Page

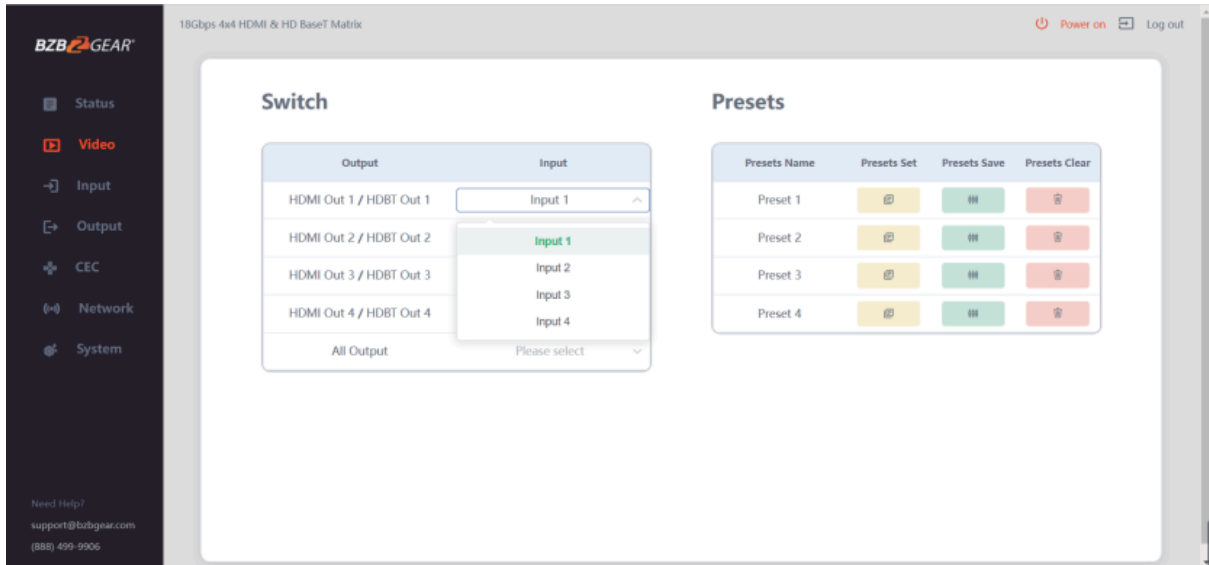

1. **Output:** The current device's OUTPUT port.
2. **Input:** You can click the drop-down menu to select a signal source for the corresponding OUTPUT port .
3. **Presets Name:** You can name the current scene with a maximum length of 12 characters.
4. **Presets Set:** You can restore the last saved audio-video matrix settings.
5. **Presets Save:** You can save audio-video matrix switching settings.
6. **Presets Clear:** You can clear the saved audio-video matrix switching settings.



## Input Page

18Gbps 4x4 HDMI & HD BaseT Matrix

Power on Log out

**Input Setting**

Inputs	Active	Name	EDID
HDMI 1	●	Input 1	1080P,Stereo Audio 2.0
HDMI 2	●	Input 2	
HDMI 3	●	Input 3	1080P,Stereo Audio 2.0 1080P,Dolby/DTS 5.1 1080P,HD Audio 7.1 1080I,Stereo Audio 2.0 1080I,Dolby/DTS 5.1 1080I,HD Audio 7.1 3D,Stereo Audio 2.0
HDMI 4	●	Input 4	

**Load EDID to user memory**

Select EDID File:

Select Destination:

**Download EDID to your computer**

Select EDID File:

1. **Inputs:** Input channel of the device.
2. **Active:** It indicates whether the channel is connected to a signal source.
3. **Name:** The input channel's name. You can modify it by entering the corresponding name (max length: 12 characters) in the input box.
4. **EDID:** You can set the current channel's EDID.

The specific operation are as follows:

### Set EDID for User

Click the "Browse" button, then select the bin file. If you select the wrong EDID file, there will be a prompt, as shown in the following figure:

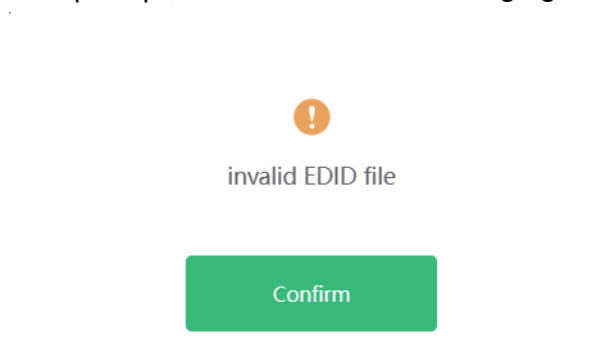



Make sure to select the correct file, then you can check the name of the selected file. Select “User 1” or “User 2”, then click “Upload”. After successful setting, it will prompt as follows:

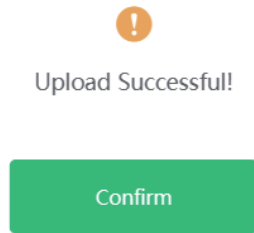

## Download the EDID File for the Corresponding Input Channel

Click the drop-down box of “Select EDID File” to select the corresponding input channel. Then click “Download” to download the corresponding EDID file.

## Output Page

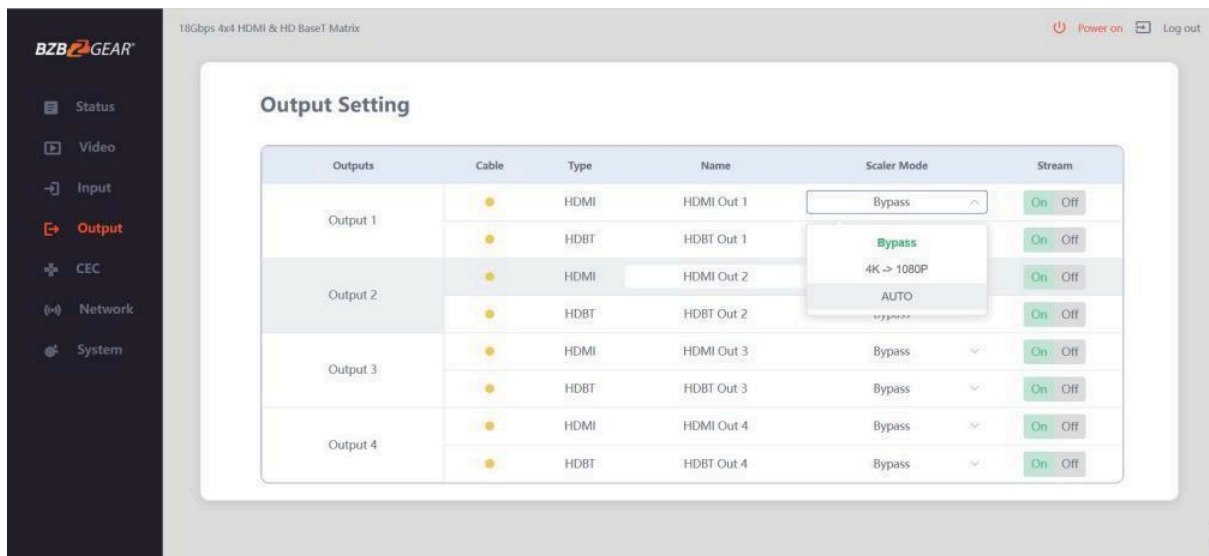

1. **Outputs:** Output channel of the device.
2. **Name:** The current output channel’s name. You can modify it by entering the corresponding name (max length: 12 characters) in the input box.
3. **Type:** The current output channel’s type (HDMI or HDBT).
4. **Cable:** It indicates the connection status of output ports. When the output port is connected to the display, it shows green, otherwise, it shows gray.
5. **Scaler Mode:** Set the current output resolution mode.
6. **Stream:** Turn on/off the output stream.



## CEC Page

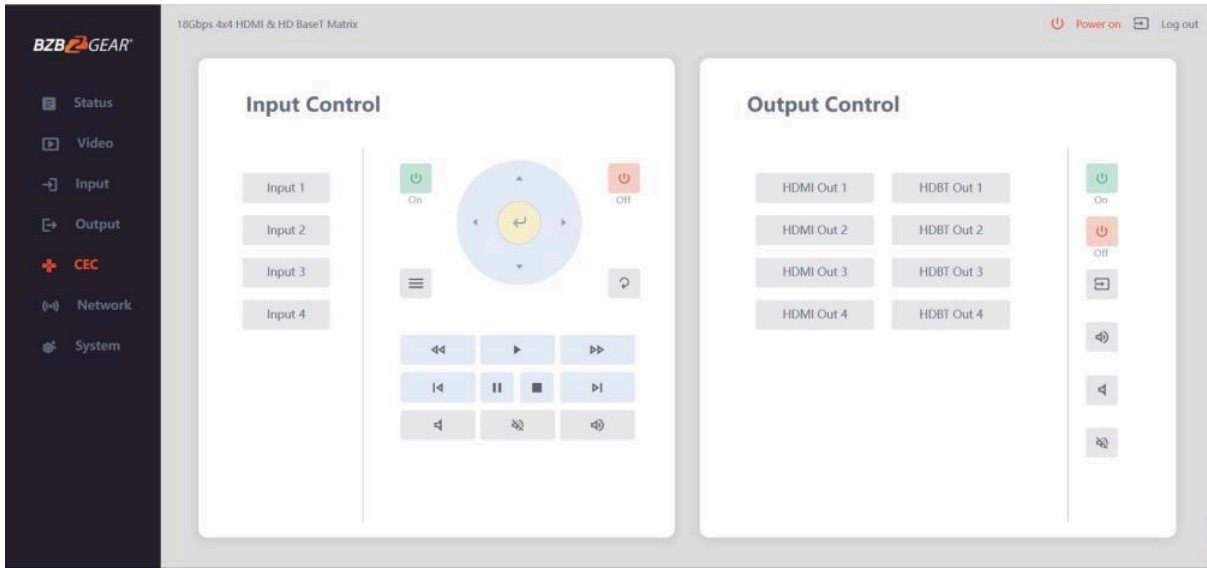

1. **Input Control:** You can control the operation of each input source by pressing the icons on the page. (You can control multiple inputs simultaneously.)
2. **Output Control:** You can control the operation of each display, such as power on/off, volume +/-, active source switching. (You can control multiple outputs simultaneously.)

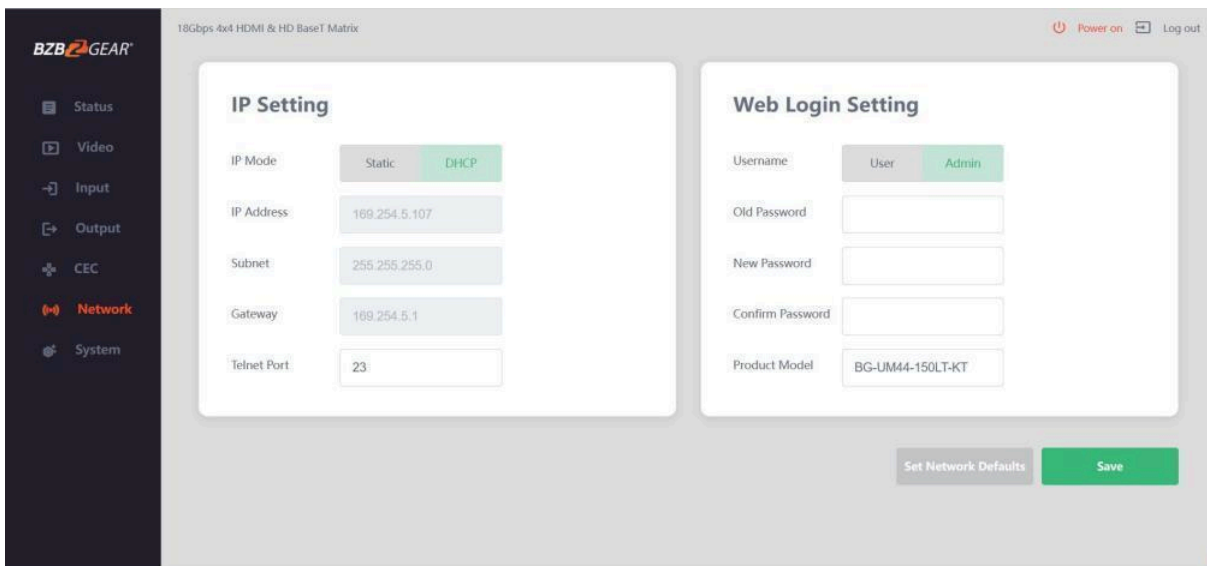



## Network Page

### Set the Default Network

Click “Set Network Defaults” button, there will be a prompt, as shown in the following figure:

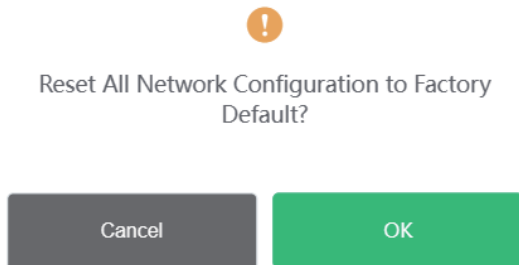

Click “OK” to search the IP Address again, as shown in the following figure:

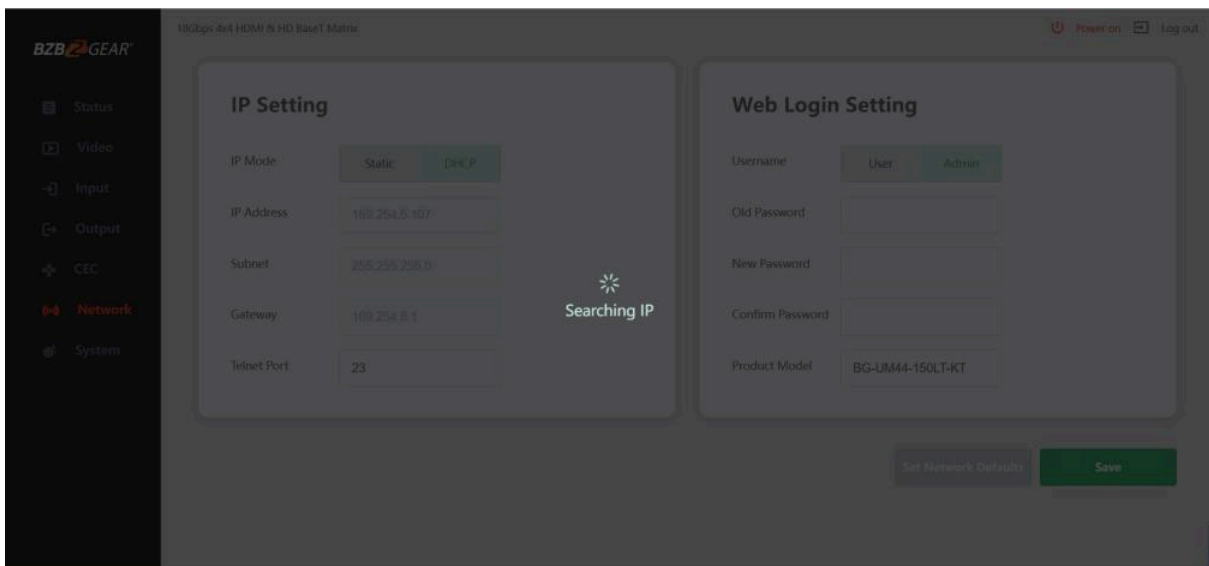

After the search is completed, it will switch to the login page with the default network settings.



## Modify User Password

Click the “User” button, enter the correct old password, new password, and confirm the new password, then click “Save.” After successful modification, there will be a prompt, as shown in the following figure:

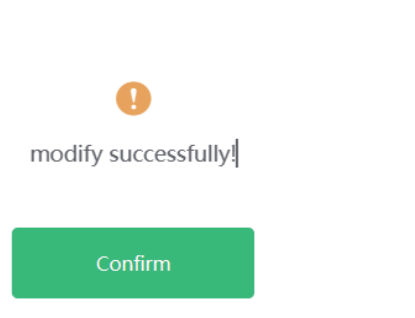

**Note:** Input rules for changing passwords:

1. The password can't be empty.
2. The new password can't be the same as the old password.
3. The new password and confirm password must be the same.

## Modify Network Setting

Modify the Mode/IP Address/Gateway/Subnet Mask/Telnet Port as required, click “Save” to save the settings.

After modification, if the Mode is set to “Static”, it will switch to the corresponding IP Address; if the Mode is “DHCP”, it will automatically search and switch to the IP Address assigned by the router.

## IP Setting

IP Mode	<input type="radio"/> Static <input checked="" type="radio"/> DHCP
IP Address	<input type="text" value="169.254.5.107"/>
Subnet	<input type="text" value="255.255.255.0"/>
Gateway	<input type="text" value="169.254.5.1"/>
Telnet Port	<input type="text" value="23"/>



## System Page

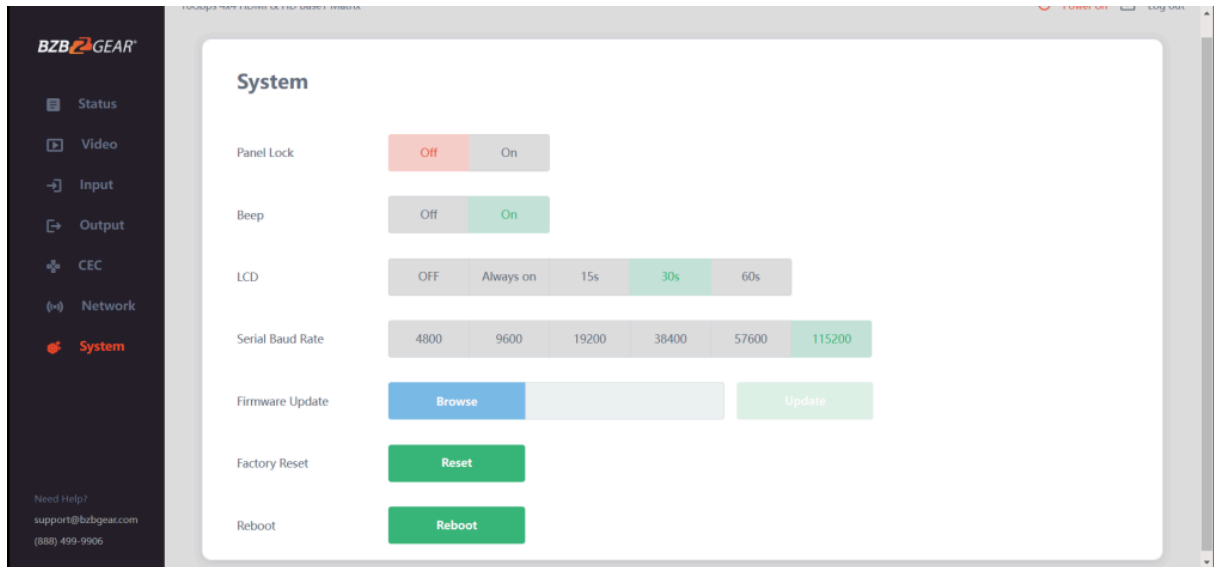

1. **Panel Lock:** Click to lock/unlock panel buttons. “On” indicates that panel buttons are unavailable; “Off” indicates panel buttons are available.
2. **Beep:** Click to turn on/off the beep.
3. **LCD:** You can turn on/off the LCD, and set the turn-on time (15s/30s/60s).
4. **Serial Baud Rate:** Click the value to set the Serial Baud Rate.
5. **Firmware Update:** Click “Browse” to select the update file, then click “Update” to complete firmware update.
6. **Factory Reset:** You can reset the machine to factory defaults by clicking “Reset”.
7. **Reboot:** You can reboot the machine by clicking “Reboot”.

**Note:** After reset/reboot, it will switch to the login page.



## RS-232 Control Commands

The product supports RS-232 control. You will need a serial cable with RS-232 male head and DB9 transfer USB male head. The RS-232 head of the serial cable is connected to the RS-232 control port with DB 9 at the rear of the Matrix, and the USB head of the serial cable is connected to a PC. The connection method is as follows:

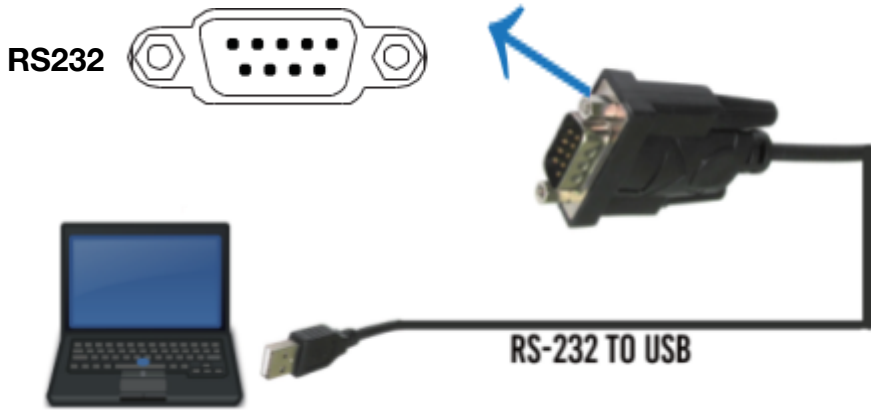

Then, open a Serial Command tool on the PC to send ASCII commands to control the Matrix. The ASCII command list about the product is shown as below.

ASCII Command
Serial port protocol. Baud rate: 115200, Data bits: 8bit, Stop bits:1, Check bit: 0
x - Parameter 1 y - Parameter 2 ! - Delimiter

Command Code	Function Description	Example	Feedback	Default Setting
<b>Power</b>				
s power z!	Power on/off the device,z=0~1 (z=0 power off, z=1 power on)	s power 1!	Power on System Initializing... Initialization Finished! FW version x.xx.xx	power on
r power!	Get current power state	r power!	power on/power off	
s reboot!	Reboot the device	s reboot!	Reboot... System Initializing... Initialization Finished! FW version x.xx.xx	
<b>System Setup</b>				
help!	List all commands	help!		
r type!	Get device model	r type!	HDP-MXB44H150	
r status!	Get device current status	r status!	Get the unit all status: power, beep, lock, in/out connection, video/audio crosspoint, edid, scaler,hdcp, network status	
r fw version!	Get Firmware version	r fw version!	MCU BOOT:Vx.xx.xx MCU APP :Vx.xx.xx SUB1 APP :Vx.xx.xx SUB2 APP :Vx.xx.xx CPLD APP :Vx.xx.xx WEB GUI :Vx.xx	
r link in x!	Get the connection status of the x input port, x=0~4(0=all)	r link in 1!	hdmi input 1: connect	
r link out y!	Get the connection status of the y output port, y=0~4(0=all)	r link out 1!	hdmi output 1: connect output 1: connect	



Command Code	Function Description	Example	Feedback	Default Setting
s reset!	Reset to factory defaults	s reset!	Reset to factory defaults System Initializing... Initialization Finished! FW version x.xx.xx	
s beep z!	Enable/Disable buzzer function, z=0~1(z=0 beep off, z=1 beep on)	s beep 1!	beep on beep off	beep on
r beep!	Get buzzer state	r beep!	beep on / beep off	
s lock z!	Lock/Unlock front panel button, z=0~1 (z=0 lock off,z=1 lock on)	s lock 1!	panel button lock on panel button lock off	panel button lock off
r lock!	Get panel button lock state	r lock!	panel button lock on/off	
s lcd on time z!	Set LCD screen remain on time, z=0~4 (0:off, 1:always on, 2:15s, 3:30s, 4:60s)	s lcd on time 1!	lcd always on	lcd on 30 seconds
r lcd mode!	Get the backlight status of lcd screen	r lcd mode!	lcd always on	
s save preset z!	Save switch state between all output port and the input port to preset z, z=1~4	s save preset 1!	save to preset 1	
s recall preset z!	Call saved preset z scenarios, z=1~4	s recall preset 1!	recall from preset 1	
s clear preset z!	Clear stored preset z scenarios, z=1~4	s clear preset 1!	clear preset 1	
r preset z!	Get preset z information, z=1~4	r preset 1!	video/audio crosspoint	
s logo1 *****!	Set the logo name displayed on the first line of LCD screen, the max character is 16	s logo1 Matrix Switich!	logo1:Matrix Swtich	
s baud rate xxx!	Set the serial port baud rate of RS02 module, z=(115200,57600, 38400,19200,9600,4800)	s baud rate 115200!	Baudrate:115200	115200
r baud rate!	Get the serial port baud rate of RS02 module	r baud rate!	Baudrate:115200	
s id z!	Set the control ID of the product, z=000~999	s id 888!	id 888	0
<b>Output Setting</b>				
s in x av out y!	Set input x to output y, x=1~4, y=0~4(0=all)	s in 1 av out 2!	input 1 -> output 2	ptp
r av out y!	Get output y signal status y=0~4(0=all)	r av out 0!	input 1 -> output 1 input 2 -> output 2 input 3 -> output 3 input 4 -> output 4	
s hdmi y stream z!	Set hdmi output y stream on/off, y=0~4(0=all) z=0~1(0:disable,1:enable)	s hdmi 1 stream 1! s hdmi 0 stream 1!	enable hdmi output 1 stream disable hdmi output 1 stream enable hdmi all outputs stream disable hdmi all outputs stream	enable
r hdmi y stream!	Get hdmi output y stream status, y=0~4(0=all)	r hdmi 1 stream!	enable hdmi output 1 stream	
s hdbt y stream z!	Set hdbt output y stream on/off, y=0~4(0=all) z=0~1(0:disable,1:enable)	s hdbt 1 stream 1! s hdbt 0 stream 1!	enable hdbt output 1 stream disable hdbt output 1 stream enable hdbt all outputs stream disable hdbt all outputs stream	enable
r hdbt y stream!	Get hdbt output y stream status, y=0~4(0=all)	r hdbt 1 stream!	enable hdbt output 1 stream	
s hdmi y scaler z!	Set hdmi output y port output scaler mode, y=0~4(0=all), z=1~3(1=bypass,2=4k->1080p, 3=Auto)	s hdmi 1 scaler 1! s hdmi 0 scaler 1!	hdmi output 1 set to bypass mode hdmi all outputs set to bypass mode	hdmi all outputs set to bypass mode



Command Code	Function Description	Example	Feedback	Default Setting
r hdmi y scaler!	Get hdmi output y port output mode y=0~4(0=all)	r hdmi 1 scaler!	hdmi output 1 set to bypass mode	
s hdbt y scaler z!	Set hdbt output y port output scaler mode, y=0~4(0=all), z=1~3(1=bypass,2=4k->1080p, 3=Auto)	s hdbt 1 scaler ! s hdbt 0 scaler !	hdbt output 1 set to bypass mode hdbt all outputs set to bypass mode	hdbt all outputs set to bypass mode
r hdbt y scaler !	Get hdbt output y port output mode y=0~4(0=all)	r hdbt 1 scaler !	hdbt output 1 set to bypass mode	
<b>EDID Setting</b>				
s edid in x from z!	Set input x EDID from default EDID z, x=0~4(0=all),z=1~31 1, 1080p,Stereo Audio 2.0 2, 1080p,Dolby/DTS 5.1 3, 1080p,HD Audio 7.1 4, 1080i,Stereo Audio 2.0 5, 1080i,Dolby/DTS 5.1 6, 1080i,HD Audio 7.1 7, 3D,Stereo Audio 2.0 8, 3D,Dolby/DTS 5.1 9, 3D,HD Audio 7.1 10, 4K2K30_444,Stereo Audio 2.0 11, 4K2K30_444,Dolby/DTS 5.1 12, 4K2K30_444,HD Audio 7.1 13, 4K2K60_420,Stereo Audio 2.0 14, 4K2K60_420,Dolby/DTS 5.1 15, 4K2K60_420,HD Audio 7.1 16, 4K2K60_444,Stereo Audio 2.0 17, 4K2K60_444,Dolby/DTS 5.1 18, 4K2K60_444,HD Audio 7.1 19, 4K2K60_444,Stereo Audio 2.0 HDR 20, 4K2K60_444,Dolby/DTS 5.1 HDR 21, 4K2K60_444,HD Audio 7.1 HDR 22, User define1 23, User define2 24~27, copy from hdmi output 1~4 28~31, copy from hdbt output 1~4	s edid in 1 from 1! s edid in 0 from 1!	input 1 EDID:1080p, Stereo Audio 2.0 all inputs EDID:1080p, Stereo Audio 2.0	1080p, Stereo Audio 2.0
r edid in x!	Get EDID status of the input x, x=0~4(0=all input)	r edid in 0!	input1 EDID: 4K2K60_444,Stereo Audio 2.0 input2 EDID: 4K2K60_444,Stereo Audio 2.0 input3 EDID: 4K2K60_444,Stereo Audio 2.0 input4 EDID: 4K2K60_444,Stereo Audio 2.0	
r edid data hdmi y!	Get the EDID data of the hdmi output y port, y=1~4	r edid data hdmi 1!	EDID: 00 FF FF FF FF FF FF 00 .....	
r edid data hdbt y!	Get the EDID data of the hdbt output y port, y=1~4	r edid data hdbt 1!	EDID: 00 FF FF FF FF FF FF 00 .....	
<b>CEC Setting</b>				
s cec in x on!	set input x power on by CEC, x=0~4(0=all input)	s cec in 1 on!	input 1 power on	
s cec in x off!	set input x power off by CEC, x=0~4(0=all input)	s cec in 1 off!	input 1 power off	
s cec in x menu!	set input x open menu by CEC, x=0~4(0=all input)	s cec in 1 menu!	input 1 open menu	
s cec in x play!	set input x play by CEC, x=0~4(0=all input)	s cec in 1 play!	input 1 play operation	
s cec in x pause!	set input x pause by CEC, x=0~4(0=all input)	s cec in 1 pause!	input 1 pause operation	



Command Code	Function Description	Example	Feedback	Default Setting
s cec in x stop!	set input x stop by CEC, x=0~4(0=all input)	s cec in 1 stop!	input 1 stop operation	
s cec in x rew!	set input x rewind by CEC, x=0~4(0=all input)	s cec in 1 rew!	input 1 rewind operation	
s cec in x mute!	set input x volume mute by CEC, x=0~4(0=all input)	s cec in 1 mute!	input 1 volume mute	
s cec in x vol-!	set input x volume down by CEC, x=0~4(0=all input)	s cec in 1 vol-!	input 1 volume down	
s cec in x vol+!	set input x volume up by CEC, x=0~4(0=all input)	s cec in 1 vol+!	input 1 volume up	
s cec in x ff!	set input x fast forward by CEC, x=0~4(0=all input)	s cec in 1 ff!	input 1 fast forward operation	
s cec in x previous!	set input x previous by CEC, x=0~4(0=all input)	s cec in 1 previous!	input 1 previous operation	
s cec in x next!	set input x next by CEC, x=0~4(0=all input)	s cec in 1 next!	input 1 next operation	
s cec hdmi out y on!	set hdmi output y power on by CEC, y=0~4(0=all hdmi output)	s cec hdmi out 1 on!	hdmi output 1 power on	
s cec hdbt out y on!	set hdbt output y power on by CEC, y=0~4(0=all hdbt output)	s cec hdbt out 1 on!	hdbt output 1 power on	
s cec hdmi out y off!	set hdmi output y power off by CEC, y=0~4(0=all hdmi output)	s cec hdmi out 1 off!	hdmi output 1 power off	
s cec hdbt out y off!	set hdbt output y power off by CEC, y=0~4(0=all hdbt output)	s cec hdbt out 1 off!	hdbt output 1 power off	
s cec hdmi out y mute!	set hdmi output y volume mute by CEC, y=0~4(0=all hdmi output)	s cec hdmi out 1 mute!	hdmi output 1 volume mute	
s cec hdbt out y mute!	set hdbt output y volume mute by CEC, y=0~4(0=all hdbt output)	s cec hdbt out 1 mute!	hdbt output 1 volume mute	
s cec hdmi out y vol-!	set hdmi output y volume down by CEC, y=0~4(0=all hdmi output)	s cec hdmi out 1 vol-!	hdmi output 1 volume down	
s cec hdbt out y vol-!	set hdbt output y volume down by CEC, y=0~4(0=all hdbt output)	s cec hdbt out 1 vol-!	hdbt output 1 volume down	
s cec hdmi out y vol+!	set hdmi output y volume up by CEC, y=0~4(0=all hdmi output)	s cec hdmi out 1 vol+!	hdmi output 1 volume up	
s cec hdbt out y vol+!	set hdbt output y volume up by CEC, y=0~4(0=all hdbt output)	s cec hdbt out 1 vol+!	hdbt output 1 volume up	
s cec hdmi out y active!	set hdmi output y active source by CEC, y=0~4(0=all hdmi output)	s cec hdmi out 1 active!	hdmi output 1 active source	
s cec hdbt out y active!	set hdbt output y active source by CEC, y=0~4(0=all hdbt output)	s cec hdbt out 1 active!	hdbt output 1 active source	
<b>Network Setting</b>				
r ipconfig!	Get the Current IP Configuration	r ipconfig!	IP Mode: Static IP: 192.168.1.72 Subnet Mask: 255.255.255.0 Gateway: 192.168.1.1 TCP/IP port=8000 Telnet port=10 Mac address: 00:1C:91:03:80:01	
r mac addr!	Get network MAC address	r mac addr!	Mac address: 00:1C:91:03:80:01	
s ip mode z!	Set network IP mode to static IP or DHCP, z=0~1 (z=0 Static, z=1 DHCP)	s ip mode 0!	Set IP mode:Static (Please use "s net reboot!" command or repower device to apply new config!)	
r ip mode!	Get network IP mode	r ip mode!	IP Mode: Static	



Command Code	Function Description	Example	Feedback	Default Setting
s ip addr xxx.xxx.xxx.xxx!	Set network IP address	s ip addr 192.168.1.100!	Set IP address: 192.168.1.100 (Please use "s net reboot!" command or repower device to apply new config!) DHCP on, Device can't config static address, set DHCP off first.	
r ip addr!	Get network IP address	r ip addr!	IP:192.168.1.100	
s subnet xxx.xxx.xxx.xxx!	Set network subnet mask	s subnet 255.255.255.0!	Set subnet Mask address:255.255.255.0 (Please use "s net reboot!" command or repower device to apply new config!) DHCP on, Device can't config subnet mask, set DHCP off first.	
r subnet!	Get network subnet mask	r subnet!	Subnet Mask: 255.255.255.0	
s gateway xxx.xxx.xxx.xxx!	Set network gateway	s gateway 192.168.1.1!	Set gateway: 192.168.1.1 Please use "s net reboot!" command or repower device to apply new config! DHCP on, Device can't config gateway, set DHCP off first.	
r gateway!	Get network gateway	r gateway!	Gateway:192.168.1.1	
s tcp/ip port x!	Set network TCP/IP port (x=1~65535)	s tcp/ip port 8000!	Set TCP/IP port:8000	
r tcp/ip port!	Get network TCP/IP port	r tcp/ip port!	TCP/IP port:8000	
s telnet port x!	Set network telnet port (x=1~65535)	s telnet port 23!	Set Telnet port:23	
r telnet port!	Get network telnet port	r telnet port!	Telnet port:23	
s net reboot!	Reboot network modules	s net reboot!	Network reboot... IP Mode: Static IP: 192.168.1.72 Subnet Mask: 255.255.255.0 Gateway: 192.168.1.1 TCP/IP port=8000 Telnet port=10 Mac address: 00:1C:91:03:80:01	
s uart x datalen y!	Set the data length of x hdbt uart, x=0-8, y=1-2, 1:8bit 2:7bit	s uart 1 datalen 1!	hdbt uart1 data len is 8bit	
s uart x baudrate y!	Set the baudrate of x hdbt uart , x=0-4, y=1-8, 1: 115200(Default) 2: 57600 3: 56000 4:38400 5:19200 6:14400 7:9600 8:4800	s uart 1 baudrate 1!	hdbt uart1 baudrate is 115200	
s uart x parity y!	Set the Parity of x hdbt uart, x=0-4, y=1-3, 1:none 2:odd 3:even	s uart x parity 1!	hdbt uart1 parity is none	
s uart x type z senddata y end!	Send data y from x hdbt uart, z=0 ascii, z=1 hex ,x=0-4	s uart 1 type 0 senddata abcdefg end!	hdbt uart1 data: abcdefg	
r uart status x!	Get the Status of x hdbt uart , x=0-4	r uart status 1!	hdbt uart1 baudrate 9600, datalen 8bit, parity none	



# Application Example

BG-UM44-150L-KIT  
Connection Diagram

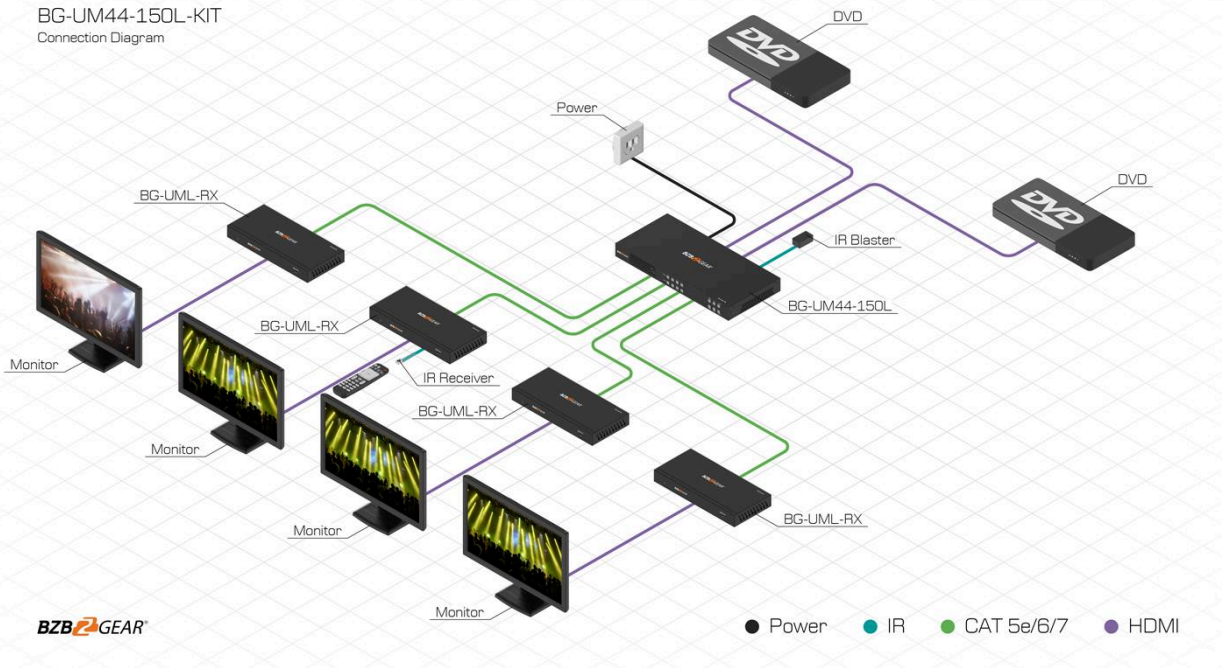



# BZBGEAR Switch Control App

## BG-Switch-Control | Quick User Guide



**BZBGEAR** Switch Control App



### Overview

The **BZBGEAR Switch Control App (BG-Switch-Control)** is a multi-platform network control application for compatible BZBGEAR matrix switchers. It provides centralized control of **video routing, audio routing, presets, and video wall configurations** through an intuitive graphical interface.

### Platform Compatibility

Supported operating systems:

- **Windows**
- **macOS**
- **iOS**
- **Android**
- All control devices must be connected to the **same local network** as the matrix switcher.

### Connection & Startup



1. Connect the BZBGEAR matrix switcher to the local network.
2. Connect the control device (PC, tablet, or smartphone) to the same network.
3. Launch the **BG-Switch-Control App**.
4. Select the correct product from the (Add Device) drop-down list



5. Fill in the device information (IP address, name, etc.)

## Matrix Switching

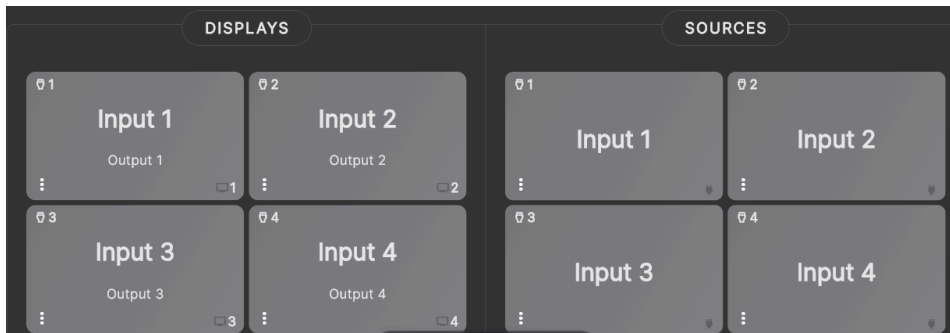

- Rename input and output sources (Optional)
- Press and hold an input source.
- Drag the input from the **Inputs panel** to the desired output.
- Release to complete the assignment.
- A single input can be routed to **multiple outputs simultaneously**.

## Preset Management

Presets allow quick saving and recall of system configurations.

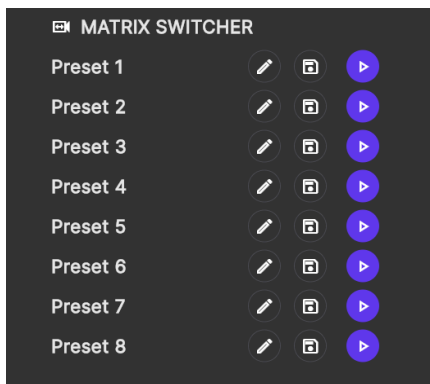

1. Configure routing or video wall settings.
2. Select **Save as Preset**.
3. Assign a preset number and name.
4. Recall presets at any time to instantly restore configurations.



## Video Wall Control

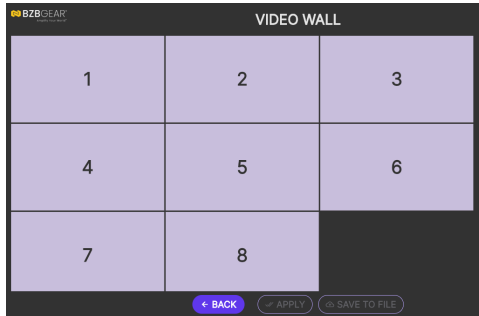

- Select **Create Video Wall**.
- Drag and arrange outputs into the desired layout.
- Select a source to span across the video wall.
- Select **Set Video Wall** to apply.
- Video walls appear on the main screen and support **real-time switching** and **preset storage**.

## Pass-Through Mode

Pass-Through mode restores a direct, default input-to-output mapping.

This mode is useful for:

- System resets
- Testing
- Simplified routing

## Refresh Data

The **Refresh Data** function resynchronizes the app with the connected switcher.

Use this if configuration changes are made or if the interface appears out of sync.

## App Capabilities

- Matrix video routing
- Video wall creation and control
- Preset save and recall
- Audio matrix control (*supported devices*)
- Multi-user access with role-based permissions
- Multi-platform operation



## Tech Support

---

Have technical questions? We may have answered them already!

Please visit BZBGear's support page ([bzbgear.com/support](https://bzbgear.com/support)) for helpful information and tips regarding our products. Here you will find our Knowledge Base ([bzbgear.com/knowledge-base](https://bzbgear.com/knowledge-base)) with detailed tutorials, quick start guides, and step-by-step troubleshooting instructions. Or explore our YouTube channel, BZB TV ([youtube.com/c/BZBTVchannel](https://youtube.com/c/BZBTVchannel)), for help setting up, configuring, and other helpful how-to videos about our gear.

Need more in-depth support? Connect with one of our technical specialists directly:

<b>Phone</b>	<b>Email</b>	<b>Live Chat</b>
1.888.499.9906	<a href="mailto:support@bzbgear.com">support@bzbgear.com</a>	<a href="https://bzbgear.com">bzbgear.com</a>

## Limited Product Warranty Terms

---

Pro Line: 5-year warranty from the date of purchase for AV/Broadcasting products bought on or after August 1, 2024.

Essential Line: 3-year warranty from the date of purchase for AV/Broadcasting products bought on or after August 1, 2024.

Cables: Lifetime Limited Product Warranty.

For complete warranty information, please visit [bzbgear.com/warranty](https://bzbgear.com/warranty).

For questions, please call 1.888.499.9906 or email [support@bzbgear.com](mailto:support@bzbgear.com).



## Mission Statement

---

BZBGear is a breakthrough manufacturer of high-quality, innovative audiovisual equipment ranging from AVoIP, professional broadcasting, conferencing, home theater, to live streaming solutions. We pride ourselves on unparalleled customer support and services. Our team offers system design consultation, and highly reviewed technical support for all the products in our catalog. BZBGear delivers quality products designed with users in mind.

## Copyright

---

All the contents in this manual and its copyright are owned by BZBGear. No one is allowed to imitate, copy, or translate this manual without BZBGear's permission. This manual contains no guarantee, standpoint expression or other implies in any form. Product specification and information in this manual is for reference only and subject to change without notice.

**All rights reserved.** No reproducing is allowed without acknowledgement.