

# BG-UM44-100M-KIT

**4X4 4K 18Gbps UHD HDMI/HDBaseT/Audio Matrix Switcher with  
2-Way IR/ARC/Ethernet/IP and RS-232 Control**

## User Manual





## TABLE OF CONTENTS

Statement	3
Safety Precaution	3
Introduction	4
Features	4
Packing List	5
Specifications	5
Operation Controls and Functions	6
IR Remote	9
IR Control System	10
IR Cables	12
EDID Management	12
Matrix Audio and RS-232 Introduction	14
Web GUI User Guide	15
RS-232 Control Command	26
Application Example	32
BZBGear Switch Control App	33
Tech Support	36
Limited Product Warranty Terms	36
Mission Statement	36
Copyright	36



## Statement

---

Please read these instructions carefully before connecting, operating, or configuring this product. Please save this manual for future reference.

## Safety Precaution

---

- To prevent damaging this product, avoid heavy pressure, strong vibration, or immersion during transportation, storage, and installation.
- The housing of this product is made of organic materials. Do not expose to any liquid, gas, or solids which may corrode the shell.
- Do not expose the product to rain or moisture.
- Unplug this device during lightning storms
- Clean only with a soft dry microfiber cloth.
- To prevent the risk of electric shock, do not open the case. Installation and maintenance should only be carried out by qualified technicians.
- Do not use the product beyond the specified temperature, humidity, or power supply specifications.
- This product does not contain parts that can be maintained or repaired by users. Damage caused by dismantling the product without authorization from BZBGear is not covered under the warranty policy.
- Installation and use of this product must strictly comply with local electrical safety standards.
- Only use accessories specified by the manufacture
- Product specifications may be subject to technical upgrades without further notice



## Introduction

---

The BG-UM44-100M-KIT is a 4K UHD 4X4 HDMI HDBaseT matrix switch that can connect four HDMI sources to eight displays. This device features four HDMI outputs mirrored to four simultaneous HDBaseT outputs. The HDBaseT outputs can extend a 4K@60Hz 4:4:4 video signal at distances up to 328 feet (100 meters) over a single Cat5e/6/7 cable.

This product is equipped with many advanced features including a 4K to 1080P down-scaler as well as smart EDID management for easy integration. This unit also offers audio de-embedding from any of the HDMI sources via analog audio and digital coaxial audio outputs.

Each extender features bi-directional IR, RS-232, and 2 LAN ports for IP control. The base unit can be operated using the front panel controls and OLED screen as well as IR, RS-232, IP control, and web interface.

## Features

---

- HDMI 2.0b, HDCP 2.2 and HDCP 1.4 compliant
- 4 HDMI inputs, 4 HDMI & HDBaseT mirrored outputs
- HDMI ports transmit 18Gbps lossless uncompressed video bandwidth
- 18Gbps lossless compressed HDBaseT signal transmission
- 4K->1080P Down Scaler
- Dolby Vision, HDR10+, HLG
- HDBaseT output can extend video transmission distance up to 328ft / 100 meters via a single cat5e/6/7 cable.
- HDMI audio pass-through up to 7.1CH HD audio (LPCM, Dolby TrueHD and DTS-HD Master Audio)
- ARC function on local HDMI and HDBaseT output ports
- IR matrix and Audio matrix
- Smart EDID management
- 24V POC on all HDBaseT ports
- Control via front panel buttons, IR remote, RS-232, LAN, and Web GUI



## Packing List

- 1x 4x4 HDMI and HDBaseT Matrix Switch
- 4x HDBaseT Receiver
- 1x Matrix IR Remote
- 1x 100~240V AC 50/60Hz Power cable
- 1x RS-232 serial cable (1.5 meters, male to female head)
- 8x 3-pin Phoenix Connector
- 5x IR Blaster cable (1.5 meters)
- 6x 20~60KHz IR Receiver cable (1.5 meters)
- 10x Mounting Ear (Matrix and Receiver)
- 1x User Manual

## Specifications

Technical	
HDCP Compliance	HDCP 2.2 and HDCP 1.4
Video Bandwidth	18Gbps
Video Resolution	Up to 4K2K@50/60Hz (4:4:4)
Color Space	RGB, YCbCr 4:4:4/4:2:2/4:2:0
Color Depth	12-bit (4K), 16-bit (1080P)
HDMI Audio Formats (Pass-through)	PCM2.0/5.1/7.1CH, Dolby Digital/Plus/EX, Dolby True HD, DTS, DTS-EX, DTS-96/24, DTS High Res, DTS-HD Master Audio, DSD
Coax Audio Formats	PCM 2.0, Dolby Digital / Plus, DTS,
L/R Audio Formats	PCM2.0
HDR formats	4:4:4, 4:2:2, 4:2:0 (10,12bit deep color) HDR10, HDR10+, Dolby Vision, HLG
Infrared	20KHz ~ 60KHz
ESD Protection	Human-body Model: ±8kV (Air-gap discharge), ±4kV (Contact discharge)
Connection	
Input Ports	4xINPUT [HDMI Type A, 19-pin female] 6xIR INPUT [3.5mm Stereo Mini-jack] 2xStereo Audio [3.5mm Stereo Mini-jack B] 1xSPDIF(OPTICAL) 1xSPDIF(COAX)
Output Ports	4xHDMI OUTPUT [HDMI Type A, 19-pin female] 4xHDBaseT port [RJ45] 5xIR OUTPUT [3.5mm Stereo Mini-jack] 4xRS-232 [3-pin Phoenix connector] 4xSPDIF(COAX) 4xStereo Audio [3.5mm Stereo Mini-jack] 1xLAN [RJ45]
Control Ports	1xTCP/IP [RJ45] 1xRS-232 [D-Sub 9]
HDBaseT Receiver	
Input Ports	1xHDBaseT IN [ RJ45] 1xIR IN [3.5mm Stereo Mini-jack]
Output Ports	1xHDMI OUT [HDMI Type A, 19-pin female] 1xIR OUT [3.5mm Stereo Mini-jack]
Control Ports	1xSERVICE [Micro USB, Update port] 1xRS-232 [Phoenix jack] 2xLAN [RJ45]



Mechanical			
Housing	Metal Enclosure		
Color	Black		
Dimensions	TX: 440mm (W)×274mm (D)×45mm (H) RX: 163mm (W)×90.3mm (D)×18mm (H)		
Weight	TX: 3977g, RX: 392g		
Power Supply	AC 100 - 240V 50/60Hz		
Power Consumption	70W (Max)		
Operating Temperature	0°C ~ 40°C / 32°F ~ 104°F		
Storage Temperature	-20°C ~ 60°C / -4°F ~ 140°F		
Relative Humidity	20~90% RH (non-condensing)		
Resolution / Distance	4K60 - Feet / Meters		
CAT5e/6/7	328ft / 100M		
Resolution / Cable length	4K60 - Feet / Meters	4K30 - Feet / Meters	1080P60 - Feet / Meters
HDMI IN / OUT	16ft / 5M	32ft / 10M	50ft / 15M

The use of "Premium High-Speed HDMI" cable is highly recommended.

## Operation Controls and Functions

### Matrix Panel

#### Front Panel

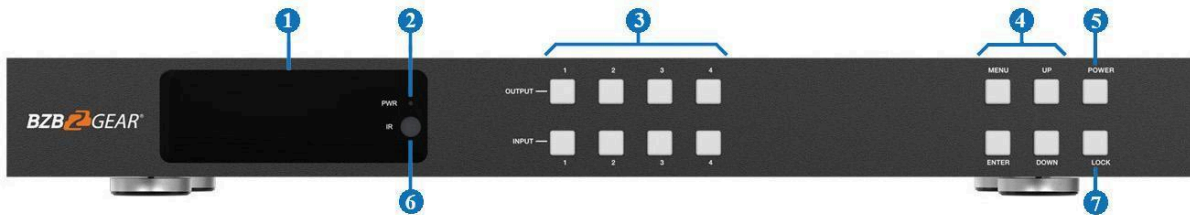

NO.	Name	Function Description
1	LED screen	Display matrix switching status, input / output port, EDID, Baud rate, IP Address.
2	Power LED	The LED will illuminate in green when the product is connected to power supply, and red when the product is on standby.
3	OUTPUT / INPUT buttons	You need to press an output button (1~4) firstly and then press an input button (1~4) to select the corresponding input source for the output port.
4	MENU / ENTER / UP / DOWN	①EDID Check: On the initial OLED display screen, press "MENU" button to enter the Matrix switching state interface, then press "UP/DOWN" button to check the current EDID information of each HDMI input port. ②EDID setting: On the initial OLED display screen, press "MENU" button to enter the EDID setting interface, press "UP/DOWN" button to select the required EDID and press the "ENTER" button. A prompt "copy to input :." will appear. Then press "UP/DOWN" button to select the input port you need to set, and press "ENTER" button again to confirm. ③Baud rate setting: On the initial OLED display screen, press "MENU" button to enter the Baud rate interface, and press "UP/DOWN" button to select the required Baud rate, finally press the "ENTER" button to confirm the setting. ④IP Address Check: On the initial OLED display screen, press "MENU" button to enter the IP interface, then press "UP/DOWN" button to check the current IP address. Pressing the "MENU" button again will return to the initial OLED display status.
5	POWER button	Press and hold the POWER button for 3 seconds to enter the standby mode, then press the button again to wake up the device.
6	IR Window	IR receiver window, it only receives the IR remote signal from this product.
7	LOCK button	Press the LOCK button to lock front panel buttons (Except the power button); Press the button again to unlock.



Rear Panel

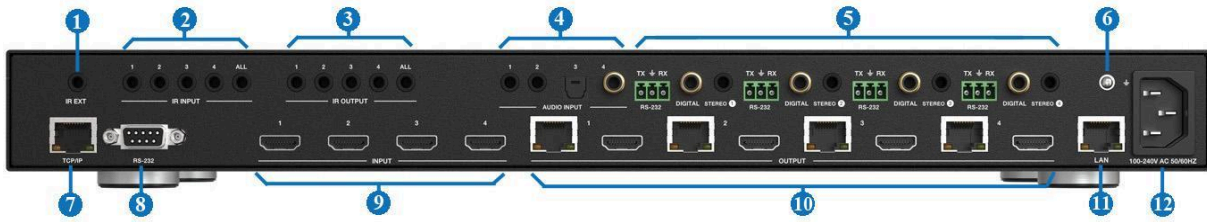

No.	Name	Function Description
1	IR EXT	If the IR receiver window of the unit is blocked or the unit is installed in a closed area out of infrared line of sight, the IR receiver cable can be inserted to the "IR EXT" port to receive the IR remote signal.
2	IR INPUT ports	Connect to IR receiver cable, the IR receive signal will emit to "IR OUT" port of the HDBaseT Receiver.
3	IR OUTPUT ports	Connect to IR blaster cable, the IR emit signal is from "IR IN" port of the HDBaseT Receiver.
4	AUDIO IN ports	L/R, optical and coaxial audio input ports, connect to external audio source device such as PC or DVD.
5	RS-232 port	Connect to a PC or control system by 3-pin phoenix connector serial cable to transmit command between the Matrix and HDBaseT Receiver.
	DIGITAL port	Coaxial audio output port, connect to audio output device such as audio amplifier via a coaxial cable.
	STEREO port	Stereo audio output port, connect to an amplifier or speaker via a 3.5mm audio cable.
6	GND	The housing is connected to the ground.
7	TCP/IP port	This port is the link port for TCP/IP control and connect to an active Ethernet link by an RJ45 cable.
8	RS-232 port	Connect to a PC or control system by D-Sub 9-pin cable to control the Matrix.
9	INPUT ports (1-4)	HDMI input ports, connect to HDMI source device such as DVD or PS4 with an HDMI cable.
10	OUTPUT ports (1-4)	HDBaseT ports, connect to HDBaseT Receiver via CAT cable. HDMI output ports, connect to HDMI display device such as TV or monitor with an HDMI cable.
11	LAN	This port is connected to a router and the LAN port of the HDBaseT Receiver can connect Internet device such as PC or laptop.
12	POWER input	Connect to 100~240V AC 50/60Hz power cable.



- Illuminating: HDMI signal with HDCP.
- Flashing: HDMI signal without HDCP.
- Dark: No HDMI signal.
- Video (OUT)
- Illuminating: Matrix and HDBaseT Receiver are in good connection status.
- Flashing: Matrix and HDBaseT Receiver are in poor connection status.
- Dark: Matrix and HDBaseT Receiver are not connected.



## HDBaseT Receiver Panel



No.	Name	Function Description
1	POWER LED	Power LED indicator, LED will illuminate when the device is connected to a power supply.
2	SERVICE port	Firmware update port
3	DC 24V	Plug the DC 24V/1A power cord into this port and connect the adapter to AC wall outlet. Note: The Matrix supports POC function, so the Receiver doesn't need a power supply when HDBaseT IN port is connected to HDBaseT port of the Matrix.
4	HDBaseT IN port	Connect to HDBaseT output port of the Matrix with CAT cable.
5	Connection Signal Indicator Lamp (Green)	<ul style="list-style-type: none"> <li>• Illuminating: Matrix and Receiver are in good connection status.</li> <li>• Flashing: Matrix and Receiver are in poor connection status.</li> <li>• Dark: Matrix and Receiver are not connected.</li> </ul>
6	Data Signal Indicator Lamp (Orange)	<ul style="list-style-type: none"> <li>• Illuminating: HDMI signal with HDCP.</li> <li>• Flashing: HDMI signal without HDCP.</li> <li>• Dark: No HDMI signal.</li> </ul>
7	IR IN	Connect to IR receiver cable, the IR signal will emit to IR OUT port of the Matrix.
8	IR OUT	Connect to IR blaster cable, the IR emit signal is from IR IN port of the Matrix.
9	HDMI OUT port	HDMI output port, connect to HDMI display device such as TV or monitor with HDMI cable.
10	RS-232 port	Connect to a PC or control system by 3-pin phoenix connector cable to transmit command between the Matrix and HDBaseT Receiver.
11	LAN ports	Connect Ethernet cables to these ports to provide a wired Ethernet connection to local devices.



## IR Remote

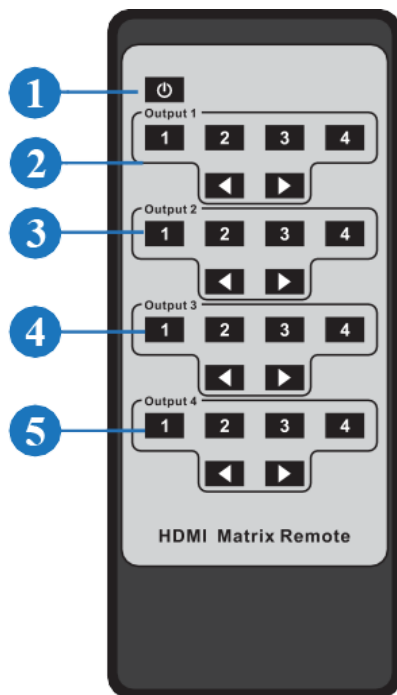

1. **Power on or Standby:** Power on the Matrix or set it to standby mode.
2. **Output 1:** Press 1\2\3\4 button to select input source to HDMI OUTPUT 1.
3. **Output 2:** Press 1\2\3\4 button to select input source to HDMI OUTPUT 2.
4. **Output 3:** Press 1\2\3\4 button to select input source to HDMI OUTPUT 3.
5. **Output 4:** Press 1\2\3\4 button to select input source to HDMI OUTPUT 4.

Select the last ◀ or next ▶ input source button.

The Matrix input and output sources can be selected by using the IR remote. There are two ways to receive the IR remote signal.

**Method 1:** The IR window accepts the IR remote signal. When using the IR remote, the furthest distance is 7 meters and the angle is  $\pm 45^\circ$ . The diagram is shown as below:

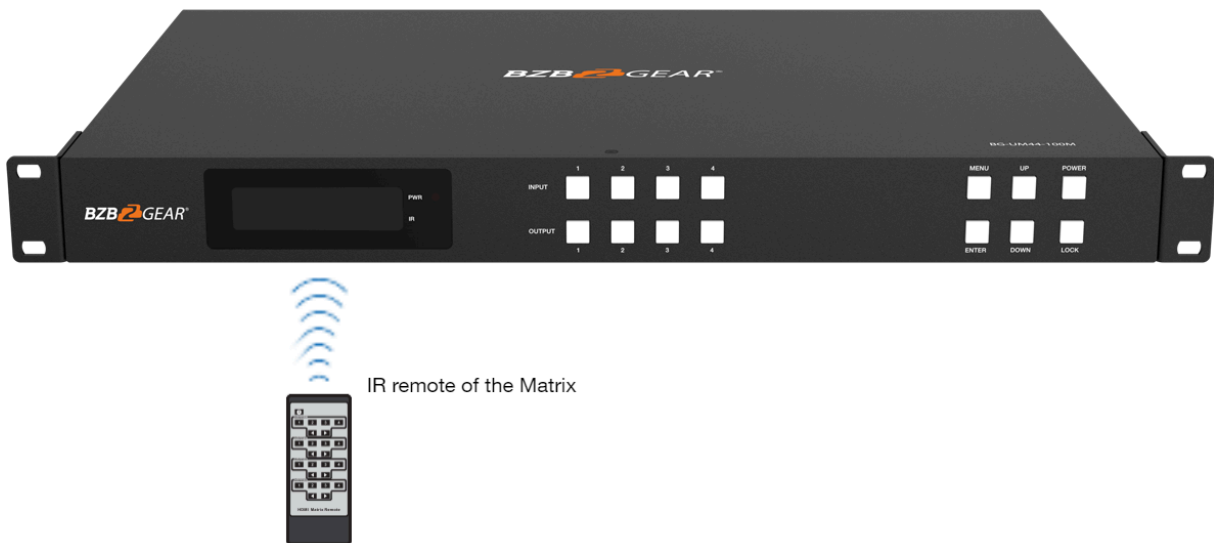



## IR Control System

The BG-UM44-100M-KIT is not only a matrix switch but also an extender that supports bi-directional IR control. When the matrix is connected to a HDBaseT receiver through a Cat 5e/6/7 cable, you can control the remote display device (HDBaseT) or input source device (matrix) through an IR signal transmission. NOTE: The IR signal transmission method is different from matrix (local) to HDBaseT receiver (remote) and from HDBaseT receiver (remote) to matrix (local).

**At the matrix (local end):** the IR signal is a one-to-one transmission. For example, the IR IN 1 port signal of the matrix will emit to the IR OUT port of the HDBaseT Receiver 1, and the IR IN 3 port of the matrix will emit a signal to the IR OUT port of the HDBaseT Receiver 3. The IR path from the base unit to the receiver is bonded to the corresponding HDMI port. The IR IN ALL port of the matrix will emit to all IR OUT ports of HDBaseT receivers simultaneously. Please see the following connection diagram.

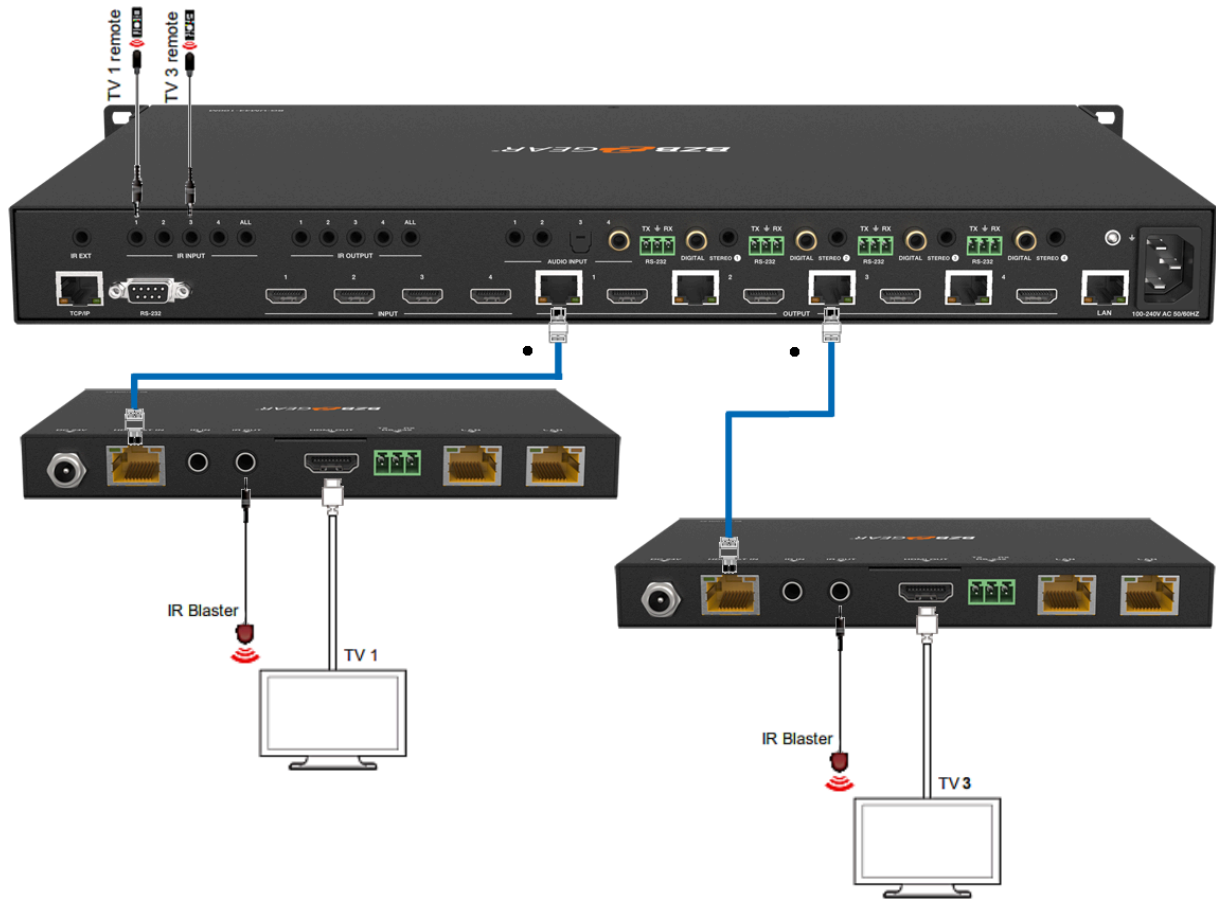
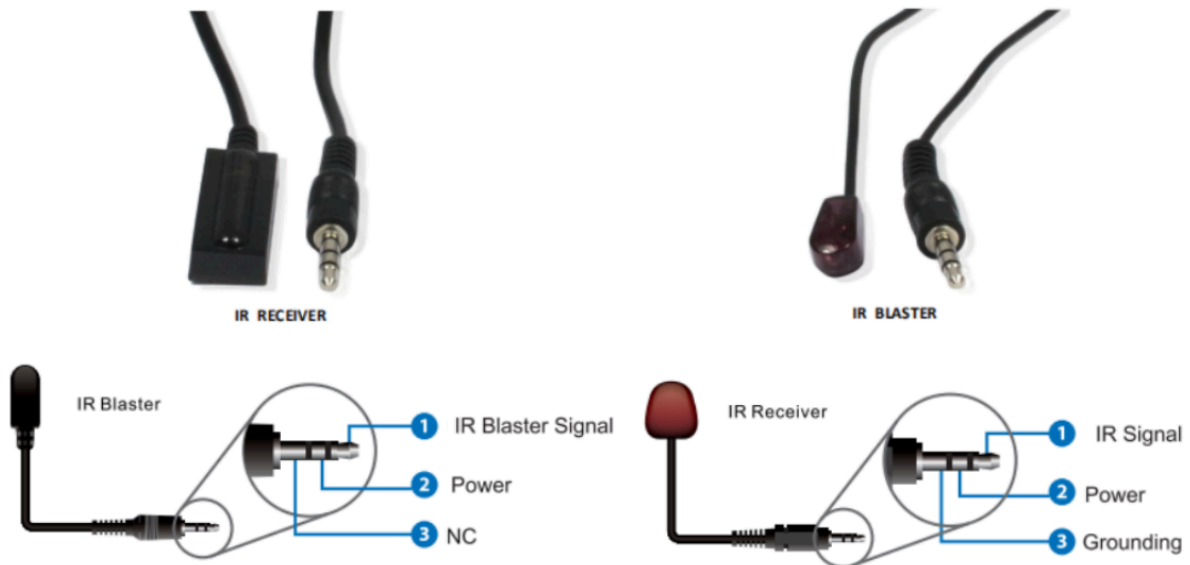

**Figure 1: IR connection diagram (Matrix end)**

**At HDBaseT Receiver (Remote end):** IR signal follows video switch/change. For example, the HDMI output signal on the HDBaseT Receiver 1 is from the HDMI INPUT 2 port, so the IR input signal of the HDBaseT Receiver 1 will emit to IR OUT 2 of the matrix. If the HDMI output signal on the HDBaseT Receiver 3 is from the HDMI INPUT 4 port. Then, the IR input signal of the HDBaseT Receiver 3 will emit to IR OUT 4 of the matrix etc. Any HDBaseT receiver's IR IN signal can output from the IR OUT ALL port of the matrix and the IR OUT ALL signal of the matrix depends on your IR remote source device. Please see the following connection diagram.



## IR Cables



## EDID Management

The BG-UM44-100M-KIT has 21 factory defined EDID settings, 2 user-defined EDID modes and 8 copy EDID modes. You can select “Defined EDID” or “Copy EDID” modes to input ports through the front panel buttons, ASCII control, or Web GUI.

**Front panel button operation:** On the initial OLED display screen press the “MENU” button to enter the EDID setting interface and then press “UP/DOWN” button to select the required EDID. Press the “ENTER” button and a prompt “copy to input :” will appear. Press the “UP/DOWN” buttons to select the input port you need to set and press the “ENTER” button again to confirm this operation.

**RS-232 control operation:** Connect the Matrix to a PC via serial cable and then open a Serial Command tool such as Dock Lite or Access Port on the PC to send the ASCII command “s edid in x from z!” to set EDID. For details, please refer to “EDID Setting” in the ASCII command list section of this manual.

**Web Interface:** Please check the EDID management sub section under the Web GUI User Guide section of this manual.

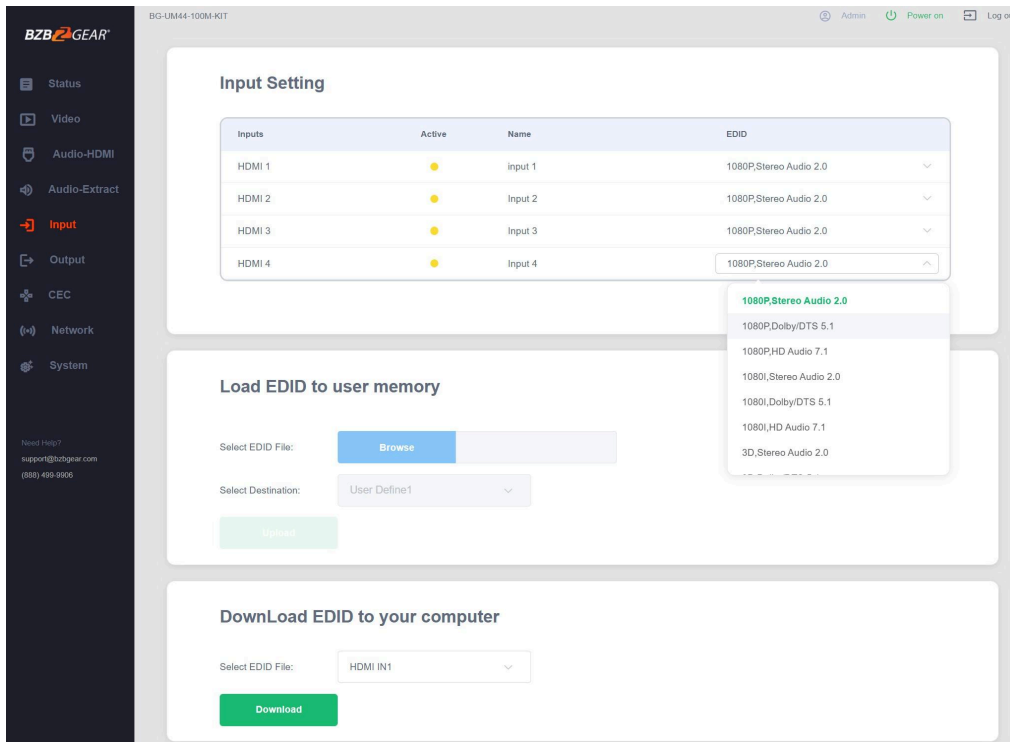

The defined EDID setting list of the product is shown as below:

EDID Mode	EDID Description
1	1080p, Stereo Audio 2.0
2	1080p, Dolby/DTS 5.1
3	1080p, HD Audio 7.1
4	1080i, Stereo Audio 2.0
5	1080i, Dolby/DTS 5.1
6	1080i, HD Audio 7.1
7	3D, Stereo Audio 2.0
8	3D, Dolby/DTS 5.1
9	3D, HD Audio 7.1
10	4K2K30_444, Stereo Audio 2.0
11	4K2K30_444, Dolby/DTS 5.1
12	4K2K30_444, HD Audio 7.1
13	4K2K60_420, Stereo Audio 2.0
14	4K2K60_420, Dolby/DTS 5.1
15	4K2K60_420, HD Audio 7.1
16	4K2K60_444, Stereo Audio 2.0
17	4K2K60_444, Dolby/DTS 5.1
18	4K2K60_444, HD Audio 7.1
19	4K2K60, Stereo Audio 2.0 HDR
20	4K2K60, Dolby/DTS 5.1 HDR
21	4K2K60, HD Audio 7.1HDR
22	User define1
23	User define2
24~27	Copy from HDMI OUTPUT 1~4
28~31	Copy from HDBT OUTPUT 1~4



## Matrix Audio and RS-232 Introduction

The matrix supports coaxial and analog audio output. The audio signal follows HDBaseT and HDMI output port. It supports one-to-one transmission. For example, the OUTPUT 1 port audio signal follows HDBaseT and HDMI 1 port, the OUTPUT 2 port audio signal follows HDBaseT and HDMI 2 port etc.

If the HDMI ARC switch and HDBaseT ARC switch are turned on by ASCII command, the coaxial and analog audio output can be the returned HDMI or HDBaseT display device's audio, the external audio source, or the extracted HDMI source device audio.

Note: multi-channel audio, 3.5 audio has no audio output.

The RS-232 channels are also one-to-one transmission. For example, the RS-232 port of OUTPUT 1 at the matrix end will transmit to the RS-232 port of HDBaseT Receiver 1, the RS-232 port of OUTPUT 3 at the matrix end will transmit to the RS-232 port of HDBaseT Receiver 3 etc. Please see the following connection diagram for reference:

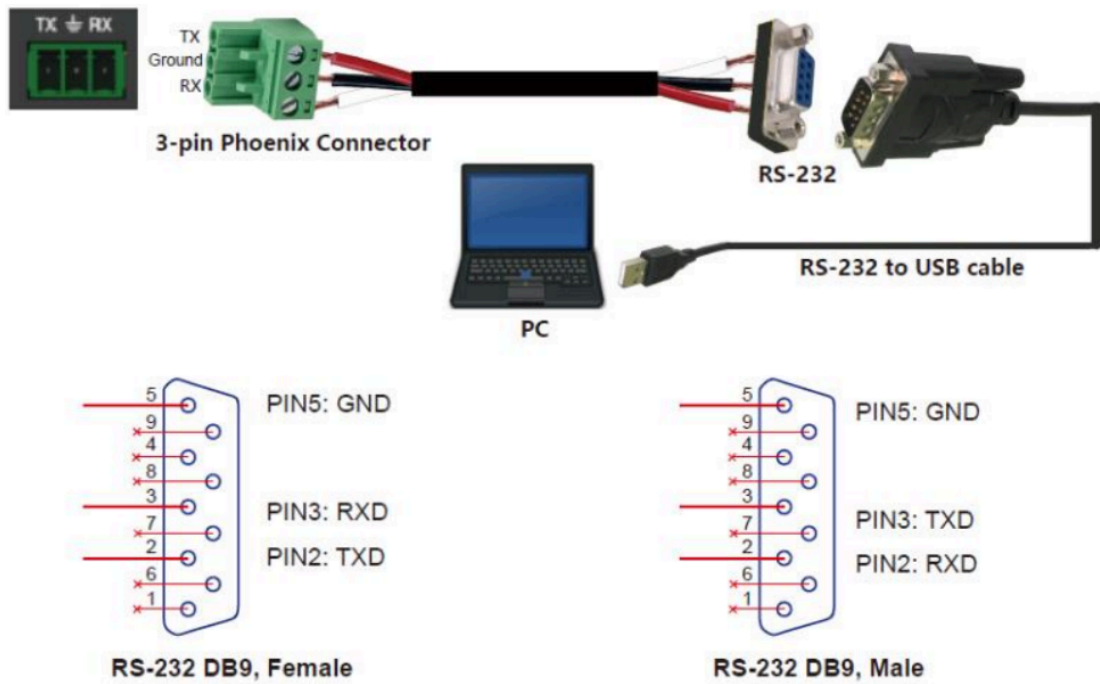



## Web GUI User Guide

---

The matrix can be controlled through a web interface and operation is shown below.

**Step 1:** Get the current IP Address.

The default IP address is 192.168.1.100. You can get the current matrix IP address in two ways:

1. You can get the IP address using the front panel buttons. On the initial OLED display, press the “MENU” button three times to enter the IP interface and check the current IP address.
2. You can get the IP address via RS-232 control. Send the ASCII command “ r ipconfig!” through a Serial Command too which will return the following information:

---

```
IP Mode: DHCP
IP:192.168.62.109
Subnet Mask:255.255.255.0
Gateway:192.168.62.1
TCP/IP port:8000
Telnet port:23
Mac address:6c-df-fb-0c-b3-8e
```

IP: 192.168.62.109 in the above figure is the IP Address of the Matrix (the IP address is variable, depending on what the specific machine returns).

For the details of RS-232 control, please refer to “12. RS-232 Control Command”.

**Step 2:** Connect the TCP/IP port of the matrix to a PC with an ethernet cable (as shown in the following figure) and set the IP address of the PC to be in the same network as the matrix.

The computer must be on the same subnet as the matrix to connect successfully. The device will not be accessible otherwise. The units default IP address is 192.168.1.100, therefore the computer must be connected to the 192.168.1.x subnet.

To connect to the matrix, open the “Local Area Connection Properties” on the computer.

For Windows users right-click on the internet connection in the lower right corner of the desktop.

Select “**Open Network & Internet Settings**”.

Select “**Change Adapter Options**”.

Right-click on your connection (Wi-Fi or Ethernet) and select “**Properties**”.



Select “**Internet protocol version 4 (TCP/IPv4)**” as shown below and click “**Properties**”.

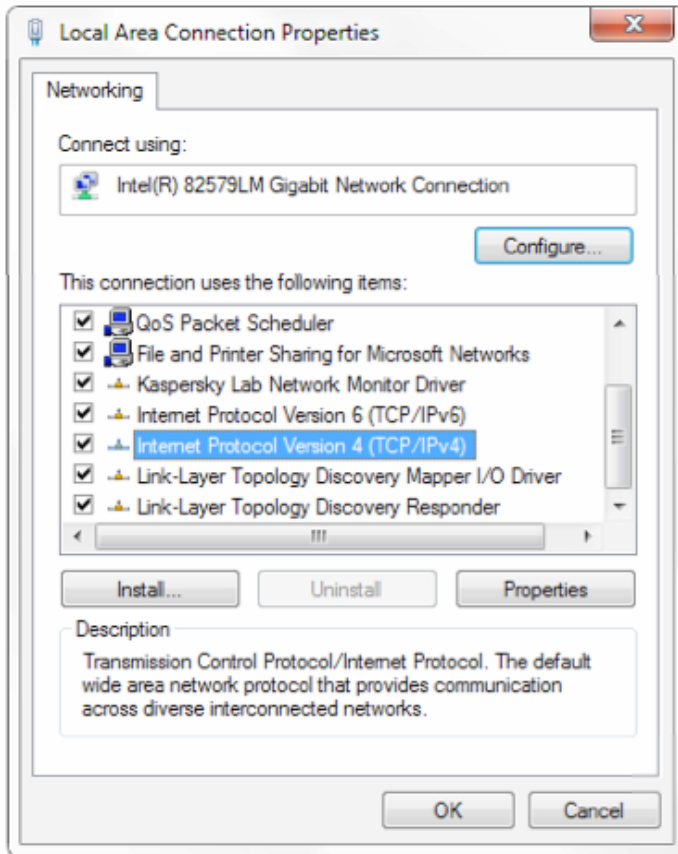

Click on the bubble for “**Use the following IP address**”

In the **IP address** field enter a non-conflicting IP address on the same subnet as the camera. If there is another device with the same IP address you will not be able to connect.

In the **Subnet mask** field enter 255.255.255.0

In the **Default gateway** field type 192.168.1.1

You can leave the DNS fields blank.

Click **OK** to apply your settings.

**Step 3:** Input the IP address into your browser on the PC to enter the Web GUI page.



After entering the IP address of the unit in the browser the Login page will appear as shown below:

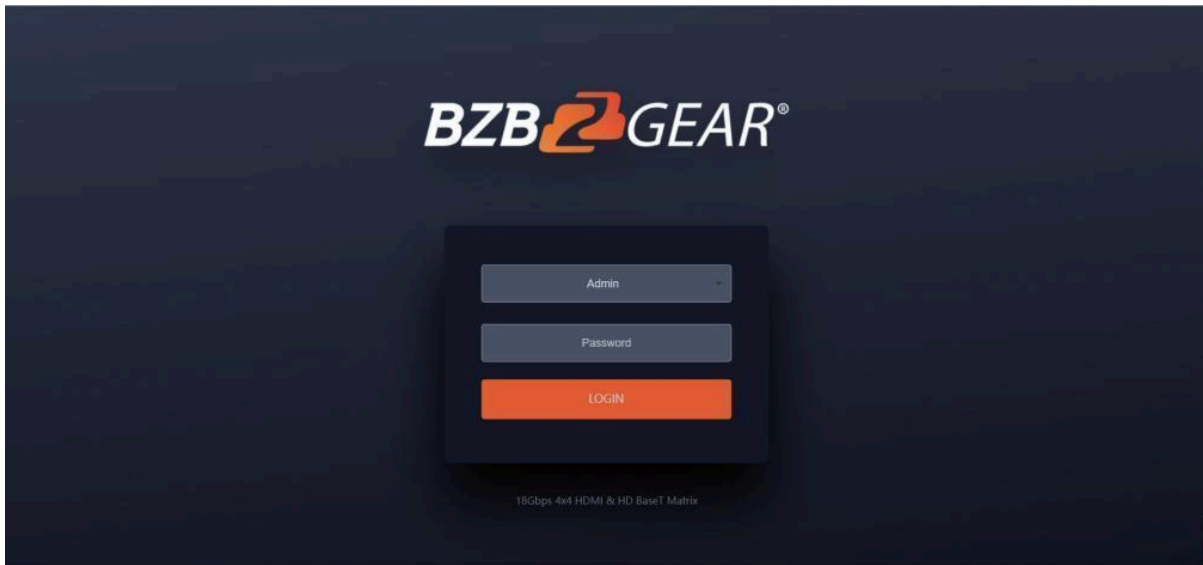

Select the Username from the list and enter the password. The default passwords are:

Username     **User**   **Admin**

Password     **user**   **admin**

After entering the password, click the “LOGIN” button and the following Status page will appear.

## Status Page

The “Status” page provides basic information about the product such as model, installed firmware version, and the network information of the device.

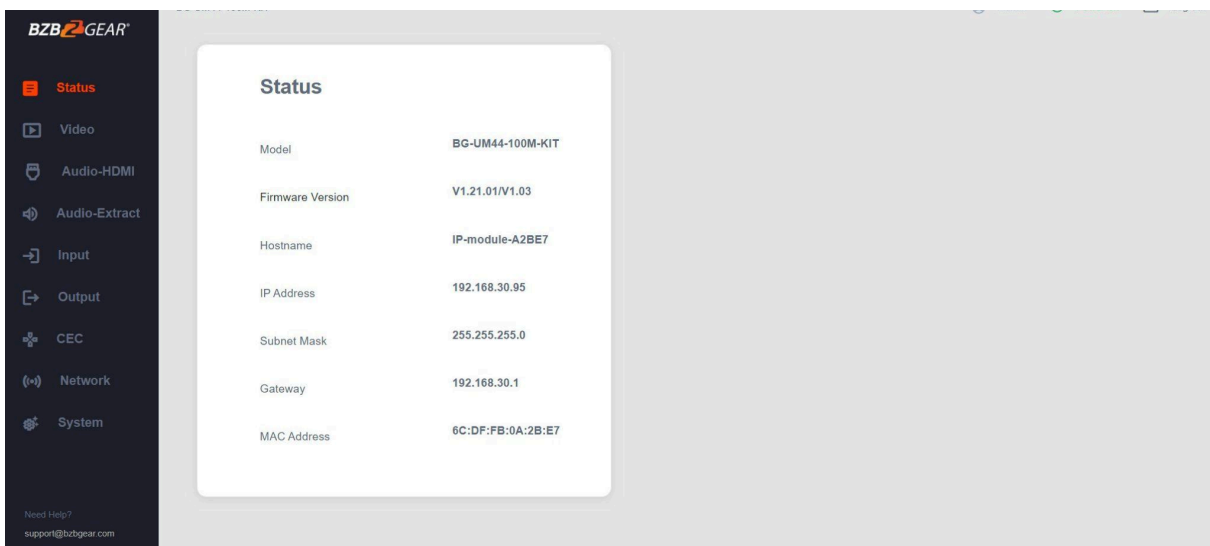



## Video Page

1. **Output:** The current device's OUTPUT port.
2. **Input:** Click the drop-down menu to select a signal source for the corresponding OUTPUT port .
3. **Presets Name:** Edit the preset name up to a maximum length of 12 characters.
4. **Presets Set:** Restore the last saved audio-video matrix settings.
5. **Presets Save:** Save the current audio-video matrix switch settings to the selected preset.
6. **Presets Clear:** Clear the saved audio-video matrix switch settings for the selected preset.



## Audio-HDMI Page

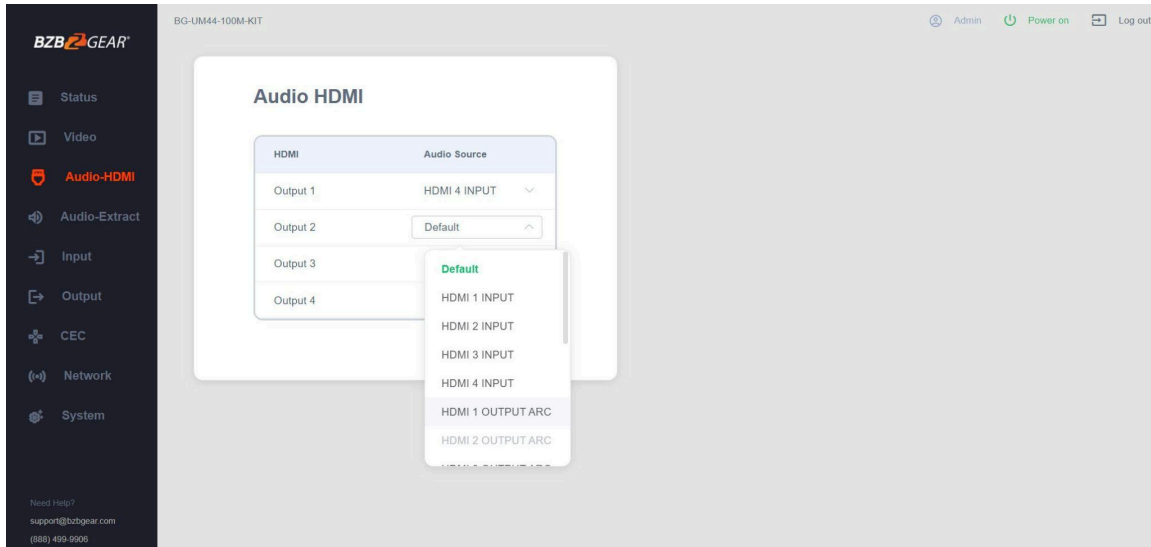

1. **HDMI:** Audio channel of the current Output.
2. **Audio Source:** The input source of the current audio channel. You can switch the input source by clicking the corresponding drop-down box to select the desired input source.

## Audio-Extract Page

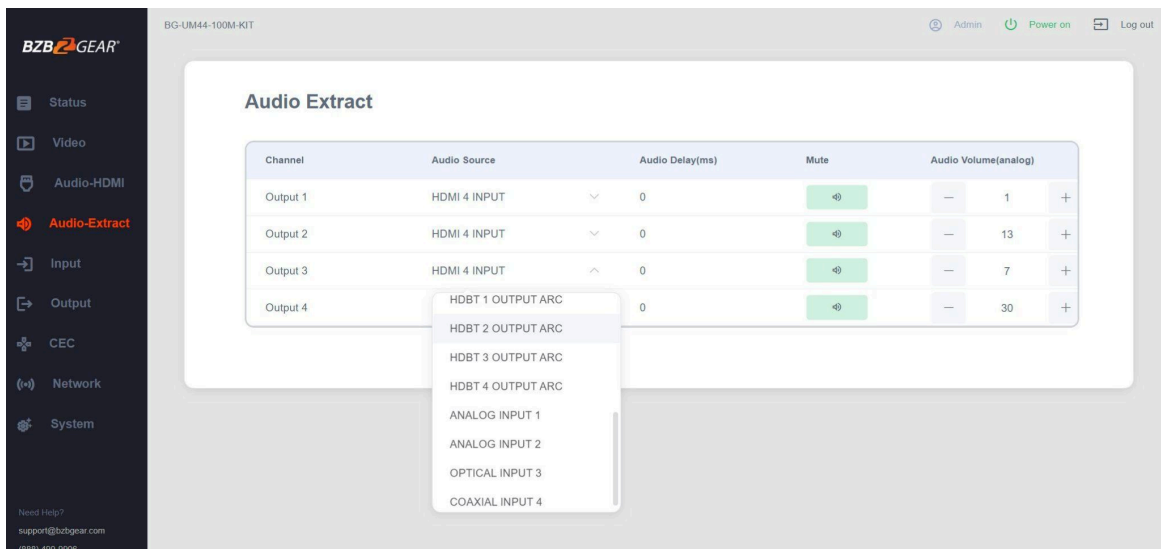

1. **Channel:** Audio output channel for coaxial audio or analog audio.
2. **Audio Source:** The input source of the current audio channel. You can switch the input source by clicking the corresponding drop-down box to select the desired input source.
3. **Audio Delay:** Set the output delay. You can modify it by entering the corresponding value (range: 0 ~ 300) in the input box.
4. **Mute:** You can mute or unmute the audio output channel by clicking the green button.
5. **Audio Volume(Analog):** You can set the volume value (range: 0~30) for the analog output channel by clicking “-”/“+” or entering the value in the input box.



## Input Page

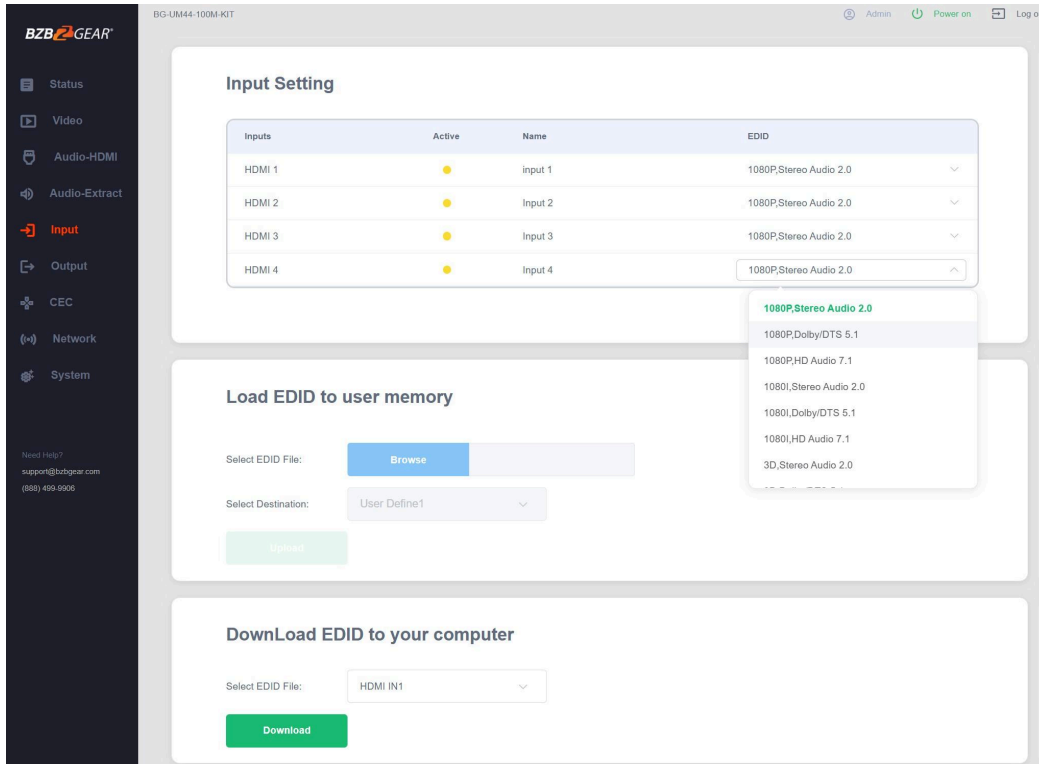

1. **Inputs:** Input channel of the device.
2. **Active:** It indicates whether the channel is connected to a signal source.
3. **Name:** The input channel's name. You can modify it by entering the corresponding name (max length: 12 characters) in the input box (Chinese name is unsupported).
4. **EDID:** You can set the current channel's EDID.

The specific operation is as follows:

### Set EDID for the User

Click the “Browse” button, then select the bin file. If you select the wrong EDID file, there will be a prompt, as shown in the following figure:

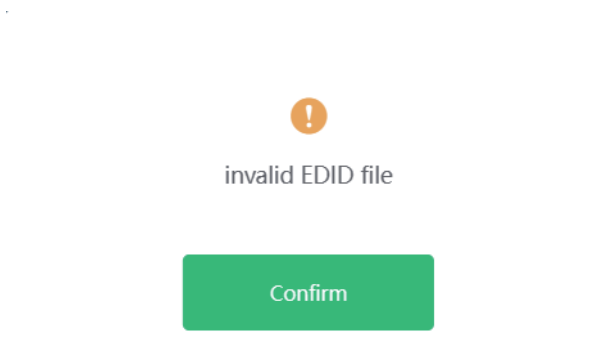



Make sure to select the correct file, then you can check the name of the selected file. Select “User 1” or “User 2”, then click “Upload”. After successful setting, it will prompt as follows:

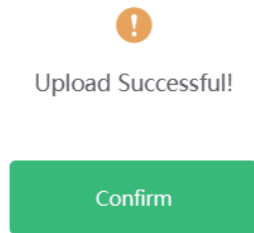

## Download the EDID File for the Corresponding Input Channel

Click the drop-down box of “Select EDID File” to select the corresponding input channel. Then click “Download” to download the corresponding EDID file.

## Output Page

Outputs	Name	Type	Cable	Scalar Mode	ARC	Stream
Output 1	HDMI Out 1	HDMI	●	AUTO	Off On	Off On
	HDBT Out 1	HDBT	●	AUTO	Off On	Off On
Output 2	HDMI Out 2	HDMI	●	AUTO	Off On	Off On
	HDBT Out 2	HDBT	●	AUTO	Off On	Off On
Output 3	HDMI Out 3	HDMI	●	Bypass	Off On	Off On
	HDBT Out 3	HDBT	●	4K -> 1080P	Off On	Off On
Output 4	HDMI Out 4	HDMI	●	AUTO	Off On	Off On
	HDBT Out 4	HDBT	●	AUTO	Off On	Off On

1. **Outputs:** Output channel of the device.
2. **Name:** The current output channel’s name. You can modify it by entering the corresponding name (max length: 12 characters) in the input box (Chinese name is unsupported).
3. **Type:** The current output channel’s type (HDMI or HDBT).
4. **Cable:** It indicates the connection status of output ports. When the output port is connected to the display, it shows green, otherwise, it shows gray.
5. **Scalar Mode:** Set the current output resolution mode.
6. **ARC:** Turn on/off the ARC function.
7. **Stream:** Turn on/off the output stream.



## CEC Page

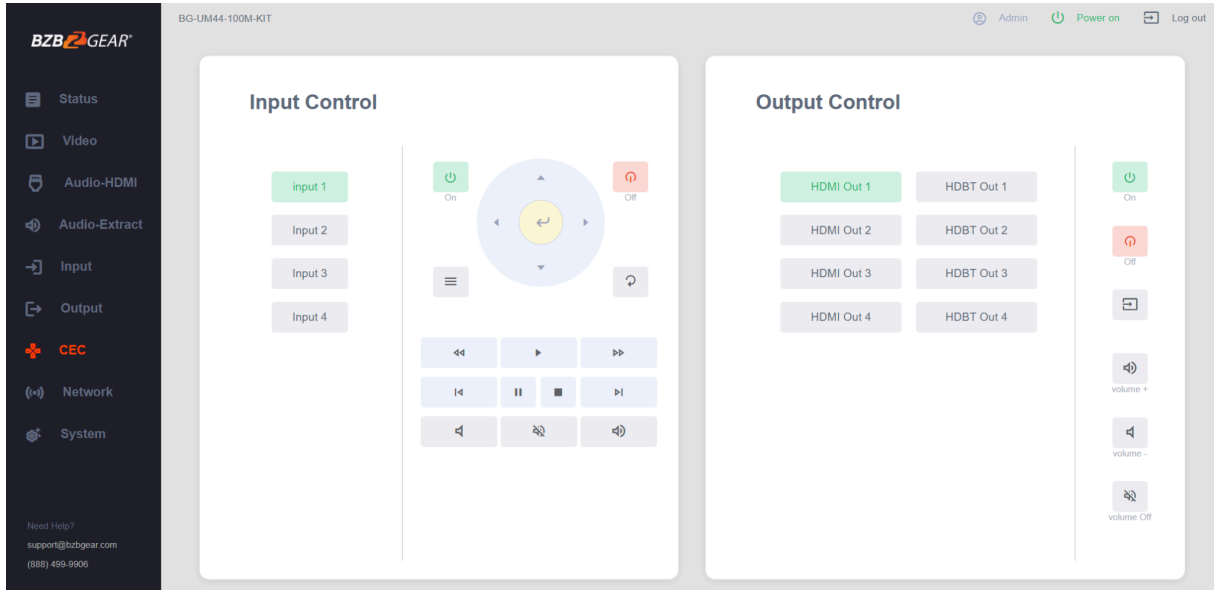

1. **Input Control:** You can control the operation of each input source by pressing the icons on the page.
2. **Output Control:** You can control the operation of each display, such as power on/off, volume +/-, active source switching.

## Network Page

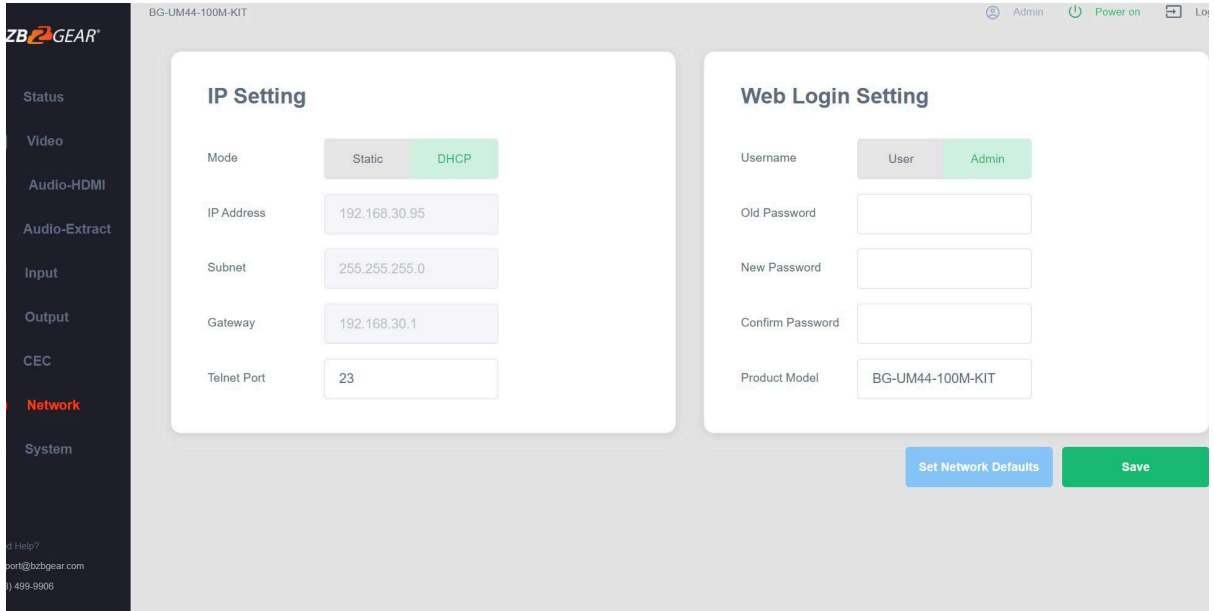



### Set the Default Network

Click “Set Network Defaults” button, there will be a prompt, as shown in the following figure:



Click “OK” to search the IP Address again, as shown in the following figure:

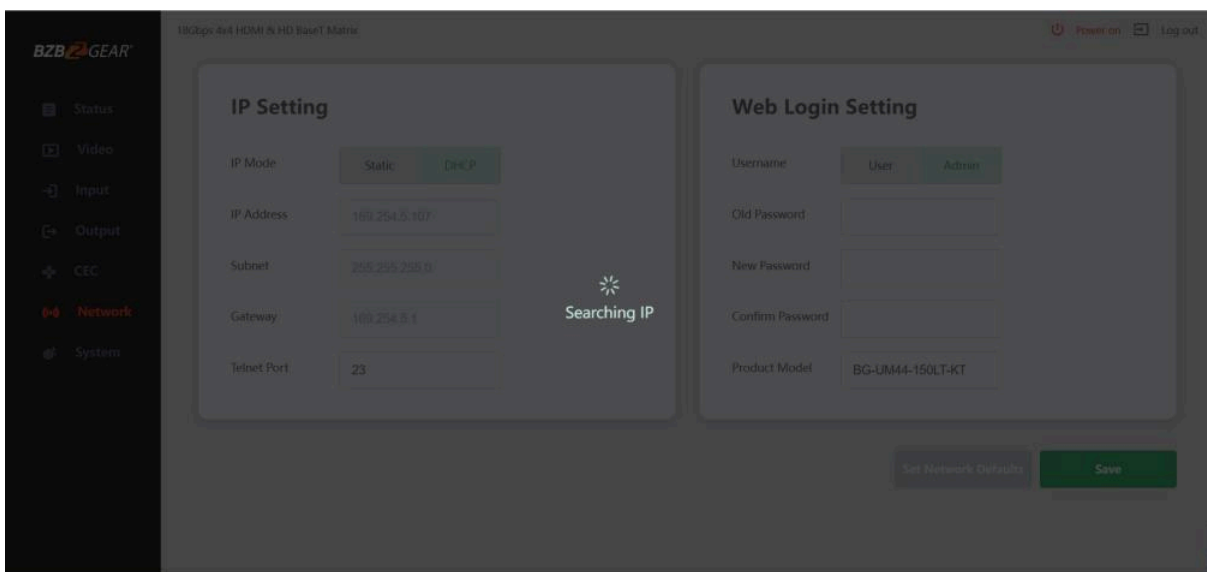

After searching is completed, it will switch to the login page, the default network setting is completed.

### Modify User Password

Click the “User” button, enter the correct Old Password, New Password, and Confirm Password, then click “Save”. After successful modification, there will be a prompt, as shown in the following figure:

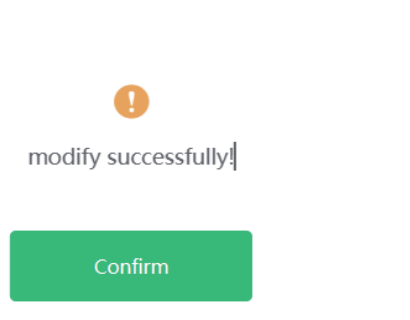



**Note:** Input rules for changing passwords:

1. The password can't be empty.
2. The new password can't be the same as the old password.
3. The new password and confirm password must be the same.

### Modify Network Setting

Modify the Mode/IP Address/Gateway/Subnet Mask/Telnet Port as required, click "Save" to save the settings, then it will come into effect.

After modification, if the Mode is "Static", it will switch to the corresponding IP Address;

if the Mode is "DHCP", it will automatically search and switch to the IP Address assigned by the router.

### IP Setting

IP Mode	<input type="radio"/> Static <input checked="" type="radio"/> DHCP
IP Address	<input type="text" value="169.254.5.107"/>
Subnet	<input type="text" value="255.255.255.0"/>
Gateway	<input type="text" value="169.254.5.1"/>
Telnet Port	<input type="text" value="23"/>



## System Page

The screenshot displays the 'System' configuration page for the BG-UM44-100M-KIT. The page features a dark sidebar on the left with navigation icons for Status, Video, Audio-HDMI, Audio-Extract, Input, Output, CEC, Network, and System. The main content area is titled 'System' and contains several settings:

- Panel Lock:** A toggle switch currently set to 'Off' (orange) and 'On' (grey).
- Beep:** A toggle switch currently set to 'Off' (grey) and 'On' (green).
- LCD:** A selection menu with options: OFF, Always on, 15s, 30s (selected), and 60s.
- Serial Baud Rate:** A selection menu with options: 4800, 9600, 19200, 38400, 57600, and 115200 (selected).
- Firmware Upgrade:** A 'Browse' button (blue) and an 'Upgrade' button (green).
- Factory Reset:** A 'Reset' button (green).
- Reboot:** A 'Reboot' button (green).

The top right corner of the interface shows 'Admin', 'Power on', and 'Log out' options. The bottom left of the sidebar contains contact information: 'Need Help? support@bzbgear.com (888) 499-9906'.

1. **Panel Lock:** Click “Panel Lock” to lock/unlock panel buttons. “On” indicates that panel buttons are unavailable; “Off” indicates panel buttons are available.
2. **Beep:** Click “Beep” to turn on/off the beep.
3. **LCD:** You can turn on/off the LCD and set the turn-on time (15s/30s/60s).
4. **Serial Baud Rate:** Click the value to set the Serial Baud Rate.
5. **Firmware Update:** Click “Browse” to select the update file, then click “Update” to complete firmware update.
6. **Factory Reset:** You can reset the machine to factory defaults by clicking “Reset”.
7. **Reboot:** You can reboot the machine by clicking “Reboot”.

**Note:** After reset/reboot, it will switch to the login page.



## RS-232 Control Command

The product also supports RS-232 control. You need a serial cable with RS-232 male head and DB9 transfer USB male head. The RS-232 head of the serial cable is connected to the RS-232 control port with DB 9 at the rear of the Matrix, and the USB head of the serial cable is connected to a PC. The connection method is as follows:

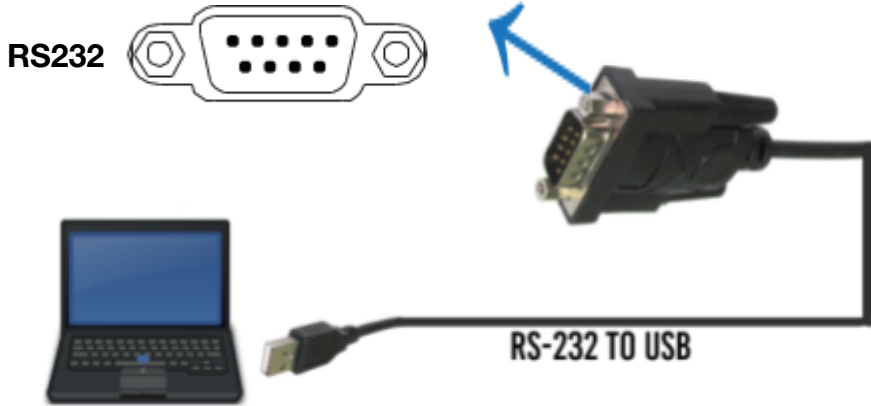

Then, open a Serial Command tool on PC to send ASCII command to control the Matrix.

The ASCII command list about the product is shown as below.

ASCII Command				
Serial port protocol. Baud rate: 115200, Data bits: 8bit, Stop bits:1, Check bit: 0				
x - Parameter 1 y - Parameter 2 ! - Delimiter				
ASCII Command	Function Description	Example	Feedback	Default Setting
<b>Power</b>				
s power z!	Power on/off the device,z=0~1 (z=0 power off, z=1 power on)	s power 1!	Power on System Initializing... Initialization Finished! power off POWER 0	power on
r power!	Get current power state	r power!	power on/power off	
s reboot!	Reboot the device	s reboot!	Reboot... System Initializing... Initialization Finished! FW version 1.00.01	
<b>System Setup</b>				
help!	List all commands	help!		
r type!	Get device model	r type!	HDM-B44H100P	
r status!	Get device current status	r status!	Get the unit all status: power, beep, lock, in/ out connection, video/ audio crosspoint, edid, scaler,hdcp, network status	
r fw version!	Get Firmware version	r fw version!	MCU BOOT: V1.00.02 MCU APP: V1.00.01 WEB GUI: V1.01	
r link in x!	Get the connection status of the x input port, x=0~4(0=all)	r link in 1!	hdmi input 1: connect	
r link out y!	Get the connection status of the y output port, y=0~40=all)	r link out 1!	hdmi output 1: connect hdbt output 1: connect	
s reset!	Reset to factory defaults	s reset!	Reset to factory defaults System Initializing... Initialization Finished! FW version 1.00.01	



ASCII Command	Function Description	Example	Feedback	Default Setting
s beep z!	Enable/Disable buzzer function, z=0~1(z=0 beep off, z=1 beep on)	s beep 1!	beep on beep off	beep on
r beep!	Get buzzer state	r beep!	beep on / beep off	
s lock z!	Lock/Unlock front panel button, z=0~1 (z=0 lock off,z=1 lock on)	s lock 1!	panel button lock on panel button lock off	panel button lock off
r lock!	Get panel button lock state	r lock!	panel button lock on/off	
s lcd on time z!	Set LCD screen remain on time, z=0~4 (0:off, 1:always on, 2:15s, 3:30s, 4:60s)	s lcd on time 1!	lcd on always	lcd on 30 seconds
r lcd mode!	Get the backlight status of lcd screen	r lcd mode!	lcd on always	
s save preset z!	Save switch state between all output port and the input port to preset z, z=1~4	s save preset 1!	save to preset 1	
s recall preset z!	Call saved preset z scenarios, z=1~4	s recall preset 1!	recall from preset 1	
s clear preset z!	Clear stored preset z scenarios, z=1~4	s clear preset 1!	clear preset 1	
r preset z!	Get preset z information, z=1~4	r preset 1!	video/audio crosspoint	
s ptp!		s ptp!	ptp	ptp
<b>Output Setting</b>				
s in x av out y!	Set input x to output y, x=1~4, y=0~4(0=all)	s in 1 av out 2!	input 1 -> output 2	input 1 -> output 1 input 2 -> output 2 input 3 -> output 3 input 4 -> output 4
r av out y!	Get output y signal status y=0~4(0=all)	r av out 0!	input 1 -> output 1 input 2 -> output 2 input 3 -> output 3 input 4 -> output 4	
s hdmi y stream z!	Set hdmi output y stream on/off, y=0~4(0=all) z=0~1(0:disable,1:enable)	s hdmi 1 stream 1! s hdmi 0 stream 1!	Enable hdmi output 1 stream Disable hdmi output 1 stream Enable hdmi all outputs stream Disable hdmi all outputs stream	Enable hdmi all outputs stream
r hdmi y stream!	Get hdmi output y stream status, y=0~4(0=all)	r hdmi 1 stream!	Enable hdmi output 1 stream Disable hdmi output 1 stream	
s hdbt y stream z!	Set hdbt output y stream on/off, y=0~4(0=all) z=0~1(0:disable,1:enable)	s hdbt 1 stream 1! s hdbt 0 stream 1!	Enable hdbt output 1 stream Disable hdbt output 1 stream Enable hdbt all outputs stream Disable hdbt all outputs stream	Enable hdbt all outputs stream
r hdbt y stream!	Get hdbt output y stream status, y=0~4(0=all)	r hdbt 1 stream!	Enable hdbt output 1 stream Disable hdbt output 1 stream	
s hdmi y scaler z!	Set hdmi output y port output scaler mode, y=0~4(0=all), z=1~3(1=bypass,2=4k->1080p, 3=Auto)	s hdmi 1 scaler 1! s hdmi 0 scaler 1!	hdmi output 1 set to bypass mode hdmi all outputs set to bypass mode	hdmi all outputs set to bypass
r hdmi y scaler!	Get hdmi output y port output mode y=0~4(0=all)	r hdmi 1 scaler!	hdmi output 1 set to bypass mode	
s hdbt y scaler z!	Set hdbt output x port output scaler mode, y=0~4(0=all), z=1~3(1=bypass,2=4k->1080p, 3=Auto)	s hdbt 1 scaler 2! s hdbt 0 scaler 2!	hdbt output 1 set to 4k->1080p mode hdbt all outputs set to 4k->1080p mode	hdbt all outputs set to bypass
r hdbt y scaler !	Get hdbt output y port output scaler mode y=0~4(0=all)	r hdbt 1 scaler !	hdbt output 1 set to 4k->1080p mode	
<b>EDID Setting</b>				
s edid in x from z!	Set input x EDID from default EDID z, x=0~4(0=all),z=1~31=1080p,Stereo Audio 2.0	s edid in 1 from 1!	IN 1 EDID:1080p, Stereo Audio 2.0	IIN1: 1080p, Stereo Audio 2.0 IN2: 1080p,



ASCII Command	Function Description	Example	Feedback	Default Setting
	2=1080p,Dolby/DTS 5.1 3=1080p,HD Audio 7.1 4=1080i,Stereo Audio 2.0 5=1080i,Dolby/DTS 5.1 6=1080i,HD Audio 7.1 7=3D,Stereo Audio 2.0 8=3D,Dolby/DTS 5.1 9=3D,HD Audio 7.1 10=4K2K30_444,Stereo Audio 2.0 11=4K2K30_444,Dolby/DTS 5.1 12=4K2K30_444,HD Audio 7.1 13=4K2K60_420,Stereo Audio 2.0 14=4K2K60_420,Dolby/DTS 5.1 15=4K2K60_420,HD Audio 7.1 16=4K2K60_444,Stereo Audio 2.0 17=4K2K60_444,Dolby/DTS 5.1 18=4K2K60_444,HD Audio 7.1 19=4K2K60_444,Stereo Audio 2.0 HDR 20=4K2K60_444,Dolby/DTS 5.1 HDR 21=4K2K60_444,HD Audio 7.1 HDR 22=User1 23=User2 24~27=copy from hdmi output 1~4 28~31=copy from hdbt output 1~4			Stereo Audio 2.0 IN3: 1080p, Stereo Audio 2.0 IN4: 1080p, Stereo Audio 2.0
r edid in x!	Get EDID status of the input x, x=0~4(0=all input)	r edid in 0!	IN1 EDID: 4K2K60_444,Stereo Audio 2.0 IN2 EDID: 4K2K60_444,Stereo Audio 2.0 IN3 EDID: 4K2K60_444,Stereo Audio 2.0 IN4 EDID: 4K2K60_444,Stereo Audio 2.0	
r edid data hdmi y!	Get the EDID data of the hdmi output y port, y=1~4	r edid data hdmi 1!	EDID: 00 FF FF FF FF FF FF 00 .....	
r edid data hdbt y!	Get the EDID data of the hdbt output y port, y=1~4	r edid data hdbt 1!	EDID: 00 FF FF FF FF FF FF 00 .....	
r internal edid!	Get all built-in EDID information for unit support	r internal edid!	1,1080p,Stereo Audio 2.0 2,1080p,Dolby/DTS 5.1 3,1080p,HD Audio 7.1 4,1080i,Stereo Audio 2.0 ..... 20,4K2K60,Dolby/ DTS 5.1 HDR 21,4K2K60,HD Audio 7.1 HDR	
<b>Audio Setting</b>				
s hdmi y arc z!	Turn on/off ARC of HDMI output y, y=0~4(0=all) z=0~1(z=0,off,z=1 on)	s hdmi 1 arc 1! s hdmi 0 arc 1!	hdmi output 1 arc on hdmi output 1 arc off hdmi all outputs arc on hdmi all outputs arc off	hdmi all outputs arc off
r hdmi y arc!	Get the ARC state of HDMI output y, y=0~4(0=all)	r hdmi 1 arc!	hdmi output 1 arc on	
s hdbt y arc z!	Turn on/off ARC of HDBT output y, y=0~4(0=all) z=0~1(z=0,off,z=1 on)	s hdbt 1 arc 1! s hdbt 0 arc 1!	hdbt output 1 arc on hdbt output 1 arc off hdbt all outputs arc on hdbt all outputs arc off	hdbt all outputs arc off
r hdbt y arc!	Get the ARC state of HDMI output y, y=0~4(0=all)	r hdbt 1 arc!	hdbt output 1 arc on	
s out y audio from z!	Set HDMI/HDBT output audio y=0~4(0=all),z=0~16 z=0, Default z=1~4 from HDMI input 1~4 z=5~8 from HDMI out 1~4 ARC z=9~12 from HDBT out 1~4 ARC z=13~16 from embed audio 1~4 Attention: when z=0,HDMI/HDBT audio can't set audio delay.	s out 1 audio from 1! s out 0 audio from 1!	HDMI/HDBT output 1 audio: from HDMI input 1 HDMI/HDBT all outputs audio: from HDMI input 1	HDMI/HDBT all outputs from default
r out y audio!	Get HDMI/HDBT output audio status y=0~4(0=all)	r out 1 audio!	HDMI/HDBT output 1 from HDMI input 1	



ASCII Command	Function Description	Example	Feedback	Default Setting
s coax_analog out y audio from z!	Set coaxial output audio y=0~4 (0=all), z=1~16 z=1~4 from HDMI input 1~4 z=5~8 from HDMI out 1~4 ARC z=9~12 from HDBT out 1~4 ARC z=13~16 from embed audio 1~4	s coax_analog out 1 audio from 1! s coax_analog out 0 audio from 1!	Coaxial_Analog output 1 audio: from HDMI input 1 Coaxial_Analog all outputs audio: from HDMI input 1	Coaxial_Analog all outputs audio: from HDMI input 1
s coax_analog out y audio delay z!	Set coax_analog output audio delay y=0~4(0=all), z=0~300ms	s coax_analog out 1 audio delay 100! s coax_analog out 0 audio delay 100!	Coaxial_Analog output 1 audio delay 100ms Coaxial_Analog all outputs audio delay 100ms	Coaxial_Analog all outputs audio delay 100ms
s coax_analog out y audio mute z!	Mute on/off coax_analog output audio y=0~4(0=all), z=0~1(z=0 off, z=1 on)	s coax_analog out 1 audio mute 1!	Mute coax_analog output 1 audio	Mute off all coax_analog output audio
s coax_analog out y audio vol z!	Set analog output audio volume y=0~4(0=all), z=0~30,+,-;	s analog out 1 audio vol 30! s analog out 1 audio vol +! s analog out 0 audio vol 30! s analog out 0 audio vol +!	Analog output 1 audio volume 30 Analog all outputs audio volume 30	all Analog output audio volume 20
r coax_analog out y audio!	Get coax_analog output audio status y=0~4(0=all)	r coax_analog out 1 audio!	Coaxial_Analog output 1 audio from HDMI input 1 Coaxial_Analog output 1 audio delay 0ms Analog output 1 audio volume 20 Mute off coax_analog output 1 audio	

**CEC Setting**

s cec in x on!	set input x power on by CEC, x=0~4(0=all input)	s cec in 1 on!	input 1 power on	
s cec in x off!	set input x power off by CEC, x=0~4(0=all input)	s cec in 1 off!	input 1 power off	
s cec in x menu!	set input x open menu by CEC, x=0~4(0=all input)	s cec in 1 menu!	input 1 open menu	
s cec in x back!	set input x back operation by CEC, x=0~4(0=all input)	s cec in 1 back!	input 1 back operation	
s cec in x up!	set input x menu up operation by CEC, x=0~4(0=all input)	s cec in 1 up!	input 1 menu up operation	
s cec in x down!	set input x menu down operation by CEC, x=0~4(0=all input)	s cec in 1 down!	input 1 menu down operation	
s cec in x left!	set input x menu left operation by CEC, x=0~4(0=all input)	s cec in 1 left!	input 1 menu left operation	
s cec in x right!	set input x menu right operation by CEC, x=0~4(0=all input)	s cec in 1 right!	input 1 menu right operation	
s cec in x enter!	set input x menu enter by CEC, x=0~4(0=all input)	s cec in 1 enter!	input 1 menu enter operation	
s cec in x play!	set input x play by CEC, x=0~4(0=all input)	s cec in 1 play!	input 1 play operation	
s cec in x pause!	set input x pause by CEC, x=0~4(0=all input)	s cec in 1 pause!	input 1 pause operation	
s cec in x stop!	set input x stop by CEC, x=0~4(0=all input)	s cec in 1 stop!	input 1 stop operation	
s cec in x rew!	set input x rewind by CEC, x=0~4(0=all input)	s cec in 1 rew!	input 1 rewind operation	
s cec in x mute!	set input x volume mute by CEC, x=0~4(0=all input)	s cec in 1 mute!	input 1 volume mute	
s cec in x vol-!	set input x volume down by CEC, x=0~4(0=all input)	s cec in 1 vol-!	input 1 volume down	
s cec in x vol+!	set input x volume up by CEC, x=0~4(0=all input)	s cec in 1 vol+!	input 1 volume up	
s cec in x ff!	set input x fast forward by CEC, x=0~4(0=all input)	s cec in 1 ff!	input 1 fast forward operation	
s cec in x previous!	set input x previous by CEC, x=0~4(0=all input)	s cec in 1 previous!	input 1 previous operation	



ASCII Command	Function Description	Example	Feedback	Default Setting
s cec in x next!	set input x next by CEC, x=0~4(0=all input)	s cec in 1 next!	input 1 next operation	
s cec hdmi out y on!	set hdmi output y power on by CEC, y=0~4(0=all hdmi output)	s cec hdmi out 1 on!	hdmi output 1 power on	
s cec hdbt out y on!	set hdbt output y power on by CEC, y=0~4(0=all hdbt output)	s cec hdbt out 1 on!	hdbt output 1 power on	
s cec hdmi out y off!	set hdmi output y power off by CEC, y=0~4(0=all hdmi output)	s cec hdmi out 1 off!	hdmi output 1 power off	
s cec hdbt out y off!	set hdbt output y power off by CEC, y=0~4(0=all hdbt output)	s cec hdbt out 1 off!	hdbt output 1 power off	
s cec hdmi out y mute!	set hdmi output y volume mute by CEC, y=0~4(0=all hdmi output)	s cec hdmi out 1 mute!	hdmi output 1 volume mute	
s cec hdbt out y mute!	set hdbt output y volume mute by CEC, y=0~4(0=all hdbt output)	s cec hdbt out 1 mute!	hdbt output 1 volume mute	
s cec hdmi out y vol-!	set hdmi output y volume down by CEC, y=0~4(0=all hdmi output)	s cec hdmi out 1 vol-!	hdmi output 1 volume down	
s cec hdbt out y vol-!	set hdbt output y volume down by CEC, y=0~4(0=all hdbt output)	s cec hdbt out 1 vol-!	hdbt output 1 volume down	
s cec hdmi out y vol+!	set hdmi output y volume up by CEC, y=0~4(0=all hdmi output)	s cec hdmi out 1 vol+!	hdmi output 1 volume up	
s cec hdbt out y vol+!	set hdbt output y volume up by CEC, y=0~4(0=all hdbt output)	s cec hdbt out 1 vol+!	hdbt output 1 volume up	
s cec hdmi out y active!	set hdmi output y active source by CEC, y=0~4(0=all hdmi output)	s cec hdmi out 1 active!	hdmi output 1 active source	
s cec hdbt out y active!	set hdbt output y active source by CEC, y=0~4(0=all hdbt output)	s cec hdbt out 1 active!	hdbt output 1 active source	
<b>Network Setting</b>				
r ipconfig!	Get the Current IP Configuration	r ipconfig!	IP Mode: DHCP IP:192.168.62.106 Subnet Mask: 255.255.255.0 Gateway:192.168.62.1 TCP/IP port:8000 Telnet port:23 Mac address: 6C:DF:FB:0C:B3:8E	
r mac addr!	Get network MAC address	r mac addr!	Mac address: 6C:DF:FB:0C:B3:8E	
s ip mode z!	Set network IP mode to static IP or DHCP, z=0~1 (z=0 Static, z=1 DHCP)	s ip mode 0!	Set IP mode:Static (Please use "s net reboot!" command or repower device to apply new config!)	DHCP ON
r ip mode!	Get network IP mode	r ip mode!	IP Mode: DHCP	
s ip addr xxx.xxx.xxx.xxx!	Set network IP address	s ip addr 192.168.1.100!	Set IP address: 192.168.1.100 (Please use "s net reboot!" command or repower device to apply new config!) DHCP on, Device can't config static address, set DHCP off first.	
r ip addr!	Get network IP address	r ip addr!	IP:192.168.62.106	
s subnet xxx.xxx.xxx.xxx!	Set network subnet mask	s subnet 255.255.255.0!	Set subnet Mask address:255.255.255.0 (Please use "s net reboot!" command or repower device to apply new config!) DHCP on, Device can't config subnet mask, set DHCP off first.	
r subnet!	Get network subnet mask	r subnet!	Subnet Mask: 255.255.255.0	
s gateway xxx.xxx.xxx.xxx!	Set network gateway	s gateway 192.168.1.1!	Set gateway: 192.168.1.1 Please use "s net reboot!" command or repower device to apply new config! DHCP on, Device can't config gateway, set DHCP off first.	
r gateway!	Get network gateway	r gateway!	Gateway:192.168.1.1	
s tcp/ip port x!	Set network TCP/IP port (x=1~65535)	s tcp/ip port 8000!	Set TCP/IP port:8000	Set tcp/ip port:8000
r tcp/ip port!	Get network TCP/IP port	r tcp/ip port!	TCP/IP port:8000	



ASCII Command	Function Description	Example	Feedback	Default Setting
s telnet port x!	Set network telnet port (x=1~65535)	s telnet port 23!	Set Telnet port:23	Set telnet port:23
r telnet port!	Get network telnet port	r telnet port!	Telnet port:23	
s net reboot!	Reboot network modules	s net reboot!	Search for IP,Please wait ...! IP Mode: DHCP IP:192.168.62.111 Subnet Mask: 255.255.255.0 Gateway:192.168.62.1 TCP/IP port:8000 Telnet port:23 Mac address: 6C:DF:FB:0C:B3:8E	
s uart x mode y!	Set the mode of x local and hdbt uart , x=0-4 ,y=0-1, 0:bypass mode, 1:user control mode	s uart 1 mode 1!	Local And Far Uart1 Control Mode	
s uart x datalen y!	Set the data length of x local and hdbt uart , x=0-8, y=1-2, 1:8bit 2:7bit	s uart 1 datalen 1!	LocalUart1 DataLen is 8bit	
s uart x baudrate y!	Set the baudrate of x local and hdbt uart , x=0-8(0=all,1~4=local uart,5~8=hdbt uart), y=1-8, 1: 115200(Default) 2: 57600 3: 56000 4:38400 5:19200 6:14400 7:9600 8:4800	s uart 1 baudrate 1!	LocalUart%d Baudrate is 115200	
s uart x parity y!	Set the Parity of x local and hdbt uart, x=0-8, y=1-3, 1:none 2:odd 3:even	s uart x parity 1!	LocalUart1 Parity is None	
s uart x type z senddata y end!	Send data y from x local and hdbt uart, z=0 ascii, z=1 hex ,x=0-4	s uart 1 type 0 senddata abcdefg end!	LocalUart1 data: abcdefg	
r uart status x!	Get the Status of x local and hdbt uart , x=0-4	r uart status 1!		



# Application Example

BG-UM44-100M-KIT  
Connection Diagram

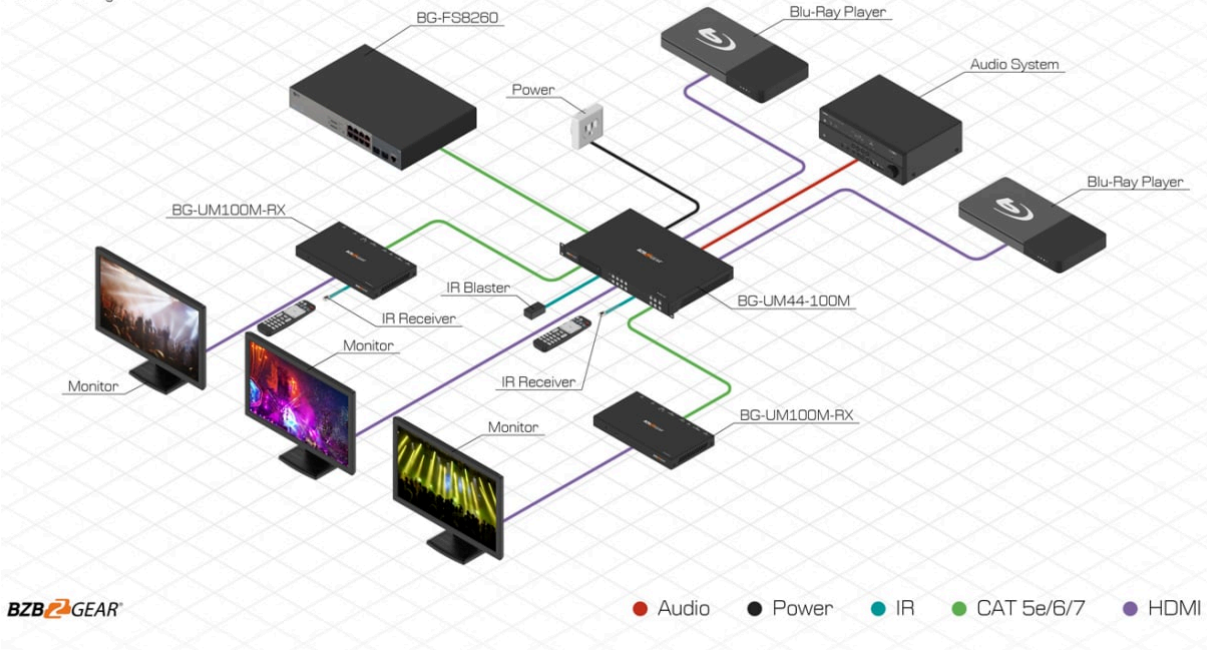



# BZBGEAR Switch Control App

## BG-Switch-Control | Quick User Guide



**BZBGEAR** Switch Control App

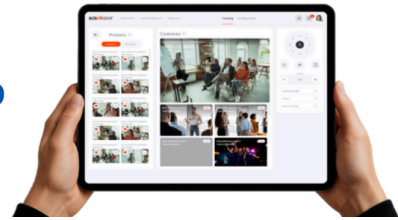

### Overview

The **BZBGEAR Switch Control App (BG-Switch-Control)** is a multi-platform network control application for compatible BZBGEAR matrix switchers. It provides centralized control of **video routing, audio routing, presets, and video wall configurations** through an intuitive graphical interface.

### Platform Compatibility

Supported operating systems:

- **Windows**
- **macOS**
- **iOS**
- **Android**
- All control devices must be connected to the **same local network** as the matrix switcher.

### Connection & Startup



1. Connect the BZBGEAR matrix switcher to the local network.
2. Connect the control device (PC, tablet, or smartphone) to the same network.
3. Launch the **BG-Switch-Control App**.
4. Select the correct product from the (Add Device) drop-down list



- Fill in the device information (IP address, name, etc.)

## Matrix Switching

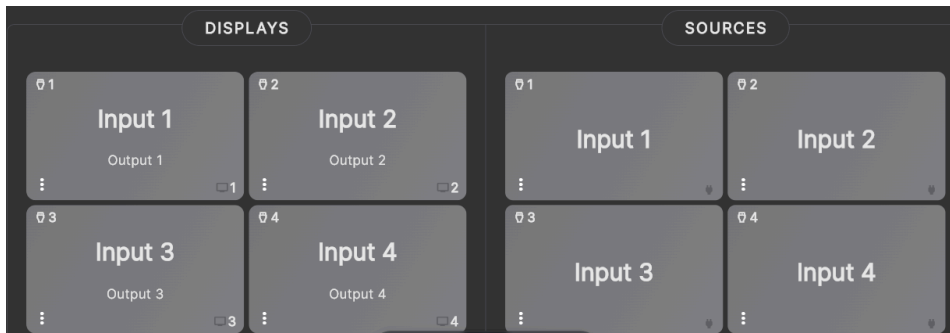

- Rename input and output sources (Optional)
- Press and hold an input source.
- Drag the input from the **Inputs panel** to the desired output.
- Release to complete the assignment.
- A single input can be routed to **multiple outputs simultaneously**.

## Preset Management

Presets allow quick saving and recall of system configurations.

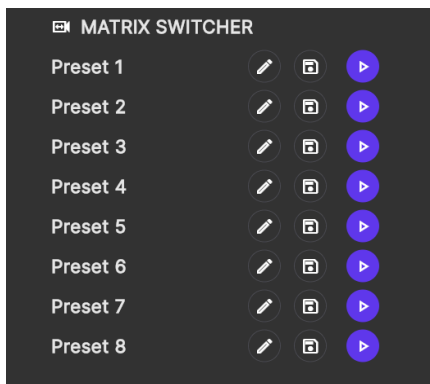

1. Configure routing or video wall settings.
2. Select **Save as Preset**.
3. Assign a preset number and name.
4. Recall presets at any time to instantly restore configurations.



## Video Wall Control

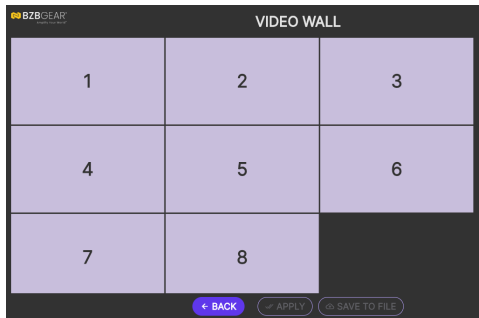

- Select **Create Video Wall**.
- Drag and arrange outputs into the desired layout.
- Select a source to span across the video wall.
- Select **Set Video Wall** to apply.
- Video walls appear on the main screen and support **real-time switching** and **preset storage**.

## Pass-Through Mode

Pass-Through mode restores a direct, default input-to-output mapping.

This mode is useful for:

- System resets
- Testing
- Simplified routing

## Refresh Data

The **Refresh Data** function resynchronizes the app with the connected switcher.

Use this if configuration changes are made or if the interface appears out of sync.

## App Capabilities

- Matrix video routing
- Video wall creation and control
- Preset save and recall
- Audio matrix control (*supported devices*)
- Multi-user access with role-based permissions
- Multi-platform operation



## Tech Support

---

Have technical questions? We may have answered them already!

Please visit BZBGear's support page ([bzbgear.com/support](https://bzbgear.com/support)) for helpful information and tips regarding our products. Here you will find our Knowledge Base ([bzbgear.com/knowledge-base](https://bzbgear.com/knowledge-base)) with detailed tutorials, quick start guides, and step-by-step troubleshooting instructions. Or explore our YouTube channel, BZB TV ([youtube.com/c/BZBTVchannel](https://youtube.com/c/BZBTVchannel)), for help setting up, configuring, and other helpful how-to videos about our gear.

Need more in-depth support? Connect with one of our technical specialists directly:

<u>Phone</u>	<u>Email</u>	<u>Live Chat</u>
1.888.499.9906	support@bzbgear.com	bzbgear.com

## Limited Product Warranty Terms

---

Pro Line: 5-year warranty from the date of purchase for AV/Broadcasting products bought on or after August 1, 2024.

Essential Line: 3-year warranty from the date of purchase for AV/Broadcasting products bought on or after August 1, 2024.

Cables: Lifetime Limited Product Warranty.

For complete warranty information, please visit [bzbgear.com/warranty](https://bzbgear.com/warranty).

For questions, please call 1.888.499.9906 or email support@bzbgear.com.

## Mission Statement

---

BZBGear is a breakthrough manufacturer of high-quality, innovative audiovisual equipment ranging from AVoIP, professional broadcasting, conferencing, home theater, to live streaming solutions. We pride ourselves on unparalleled customer support and services. Our team offers system design consultation, and highly reviewed technical support for all the products in our catalog. BZBGear delivers quality products designed with users in mind.

## Copyright

---

All the contents in this manual and its copyright are owned by BZBGear. No one is allowed to imitate, copy, or translate this manual without BZBGear's permission. This manual contains no guarantee, standpoint expression or other implies in any form. Product specification and information in this manual is for reference only and subject to change without notice.

**All rights reserved.** No reproducing is allowed without acknowledgement.